

Pioneering for You

Range Leaflet – Edition 2014 – 50 Hz

Wilo-SiFire EN Fire extinguishing systems



**“With Wilo I make
no compromises
when it comes to
fire protection.”**

The Wilo solution for fire fighting.



Check also:
productfinder.wilo.com



Wilo-SiFire EN, the steady one

- Modular and flexible system with 6 model variants for easy transport and installation
- Individually constructed units on request
- Especially designed for sprinkler systems, fully compatible with the EN 12845 standard
- Available as an easy to install compact design
- High operational reliability thanks to main and 100% redundant reserve pump (depending on system)
- Simple operation via “red-button technology”

<http://www.youtube.com/user/Wilo1872>

Fire fighting

Fire extinguishing systems



Series description Wilo-SiFire EN

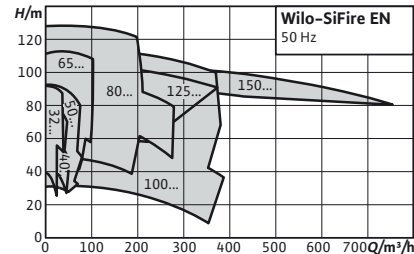

Design

Pressure boosting systems for fire fighting according to EN 12845. Consists of 1 or 2 pumps (model dependent) with horizontal base plate - EN 733 -, with spacer coupling, electric or diesel motor and multistage, electric, vertical jockey pump.

Type key

Example: **Wilo-SiFire EN 40/200-180-7.5/10.5/0.55 EDJ**

SiFire Compact pressure boosting system for fire fighting equipment

EN in acc. with EN 12845

40/200 Type of main pump

180 Actual impeller diameter of the main pump

7.5 Power of the electric motor [kW]

10.5 Power of the diesel motor [kW]

0.55 Power of the motor for the jockey pump [kW]

EDJ Configuration

E An electric pump

D A diesel pump

J A jockey pump

Application

Fully automatic water supply of fire extinguishing systems with a sprinkler system in residential, commercial, public and industrial buildings, as well as hotels, hospitals and department stores.

Special features/product advantages

- Six models are available for selection with an individual base plate and a very flexible modular version to make transport and installation easier (more than 55 kW only systems with a main pump E, D, EJ, DJ).
- Heavy-duty, horizontal, single-stage standard pump with impeller made of stainless steel AISI316/1.4401 and wear rings made of bronze; equipped with an electric or diesel motor whose rated motor power is higher than the power consumption of the pump under all conditions, notably within a volume flow range between zero and NPSHr = 16 m accordingly, as specified in the standard EN 12845
- Spacers for all motor couplings, to ensure that the internal parts of the pump are easily accessible without having to move the motor or piping
- Calibrated diaphragm at the pump outlet for a minimal bypass line to ensure that the pump is protected in the event of a low throughput

- Jockey pump to maintain the necessary pressure in the system; with automatic start/stop device
- Very high quality control system and particularly easy operation thanks to SC Fire control, with symbol-based LC display, simple user interface with clear menu layout, pressure and rotary switches for quick adjustment of parameters. Communicative controller for monitoring system operation
- Solid construction made of special profiled parts with cut-outs for forklift trucks and hooks to ensure trouble-free, safe transportation
- Special base plate for the diesel motor, which reduces the transfer of vibrations considerably and increases the reliability and service life
- The cables are concealed in the construction and protected against bumps and cuts
- The hydraulics of the entire system are pressure-loss optimised
- Custom designed units on request

Technical data

- Mains connection 3-400 V, 50 Hz (1-230 V, 50 Hz for the control panel of the diesel pump)
- IE2-equivalent standard motors, diesel motor with direct injection or turbo diesel motor with air or water cooling
- Max. ambient temperature +4°C to +40°C (+10°C to +40°C, if a diesel pump is installed)
- Max. fluid temperature +40°C
- Max. operating pressure 10 or 16 bar
- Max. inlet pressure 6 bar
- Volume flow 10 m³/h to 750 m³/h
- Max. delivery head 128 m
- Nominal connection diameters on the pressure side DN 65 to DN 250
- Nominal connection diameters on the intake side DN 50 to DN 200
- Switch cabinet protection class IP54
- Main/standby pump with horizontal base plate according to EN 733
- With epoxy resin painted piping and hydraulic connections
- Permitted fluids:
 - Non-aggressive, clean water
 - Fire water
- Note on fluids: Approved fluids are generally waters which do not attack the materials used, neither chemically nor mechanically, and do not contain any abrasive or long-fibre constituents. System in accordance with EN 12845

Equipment/function

- 1 or 2 pumps with horizontal base frame of series 32-200 to 150-315, with IE2-equivalent standard motor or diesel motor

Fire fighting

Fire extinguishing systems

Series description Wilo-SiFire EN

- With a diaphragm installed directly on the main pump housing to prevent overheating in the event of zero flow
- Jockey pump of series MVIL-1 or MVI-1 with pressure switch and vertical pressure vessel 20 l, PN16
- One switch cabinet per pump, fixed to a robust support structure. SC Fire model: E for the electric motor and D for the diesel motor, both equipped with Smart Controller, plus J for the jockey pump
- Base plate made of electro-galvanised steel with height-adjustable holder for the outlet manifold
- Pipework made of steel; painted with epoxy resin. Manifold with flanges
- Shutting gate with safety lock on the discharge side of each pump
- Non-return valve on the discharge side of each pump
- A circuit with dual pressure switch, pressure gauge, non-return valve, valve for the main pump and standby pump for automatic start
- Concentric cone on the discharge side of the main and standby pump, for speed limitation according to the parameters specified in EN 12845
- DN2" connection for the supply tank of the pumps
- Pressure measurement on the discharge side
- Only for the model with diesel motor:
 - Vibration damping sleeve on the discharge side of the pump
 - Vibration damper under the base plate of the pump
 - Fuel tank with level sensor and sufficient volume for six hours of autonomous operation
 - Two or four batteries on the base plate and battery charger at the SC Fire switch cabinet
- Accessories on request:
 - Horizontal 500 l supply tank, with float valve and pressure switch for LL-alarm (low water level)
 - Flow meter: Kit with eccentric cone on the suction side, complete with check valve with hand lever or hand wheel
 - Vacuum gauge with valve
 - Valves with electrical contact
 - Vibration damping sleeve for the manifold
 - Remote control panel for transmitting level A and level B alarms
 - Densitometer for the battery
 - Spare parts kit for the diesel motor
 - Sound absorber (30 dBA) for the diesel motor
 - Hydraulic heat exchanger for the diesel motor
- Note on fluids: Approved fluids are generally waters which do not attack the materials used, neither chemically nor mechanically, and do not contain any abrasive or long-fibre constituents. System in accordance with EN 12845

Materials

For pump with horizontal base plate

- Impellers made of stainless steel AISI 316/ 1.4401
 - Pump housing made of grey cast iron EN-GJL-250
 - Shaft made of stainless steel AISI 431/ 1.4057
 - Wear rings made of bronze
- For the jockey pump
- Impellers made of stainless steel AISI 304/ 1.4301
 - Pump housing made of grey cast iron EN-GJL-250 (stainless steel AISI304/1.4301 for MVI)
 - Shaft made of stainless steel AISI 304/ 1.4301
 - O-ring seals made of EPDM

Description/design

- Base frame: Manufactured from profiles consisting of electro-galvanised steel with brackets for the switch cabinets and the outlet manifold. Special square holes at the bottom for forklift trucks, as well as integrated hooks for lifting slings. Side profiles at the top on each side to enhance the rigidity of the system when moving and lifting.

- Plastic cover at the rear which provides visual access to the valve position and pressure gauge.
- Pipework: Complete pipework with flanges made of epoxy resin painted steel, suitable for the connection of all common piping materials; the dimensions of the pipework must correspond to the overall hydraulic performance of the pressure boosting system
- Pumps: 1 or 2 pumps with horizontal base plate - EN 733 - with spacer coupling, electric or diesel motor.
- Back-pull-out model to ensure the internal parts of the pump are easy to access without having to move the motor or piping.
- Valves: The main pumps are fitted with a check valve and non-return valve on the discharge side, both of which are painted with epoxy resin and adapted for a flange connection.
- Diaphragm pressure vessel: Diaphragm pressure vessel 20 l/PN16, on the discharge side of the jockey pump, with drain plug.
- Tank: The fuel tank is made of metal painted with epoxy resin and is located behind the bracket of the switch cabinet
- Sensors and display: 2 pressure switches, 2/16 bar per pump, on the discharge side, for activating the pump start via the SCFire controller. The discharge side pressure gauge (Ø 63 mm) is located in the middle of the rear panel.
- Controller: Each system is equipped as standard with a separate switchgear/control device (SC Fire) for the electric or diesel motor and for the jockey pump.

Scope of delivery

- Factory-mounted, ready-for-installation pressure boosting system, which has been checked for functionality and impermeability
- Packaging
- Installation and operating instructions
- Necessary accessories according to the request

Fire fighting

Fire extinguishing systems



Series description Wilo-SiFire EN

Terminal diagram

Electric pump

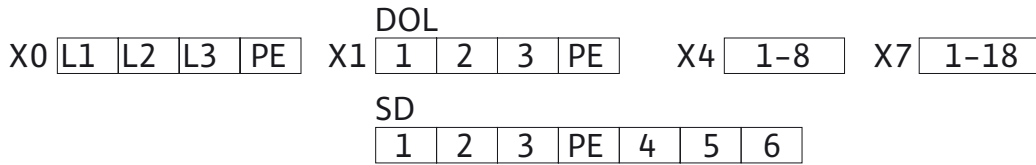

X0	Mains connection
X1	Pump connection (DOL or SD)
X4	Digital inputs
	1, 2 Freely programmable error message
	3, 4 Pump pressure switch option (NO contact)
	5, 6 Pressure switch (NO contact)
	7, 8 Float switch (NC contact)
X7	Sensor connection
	1, 2 Pressure switch (NO contact)
	3, 4 Automatic mode switched off
	5, 6 Pump is running
	7, 8 Pump request
	9, 10 Freely programmable error message
	11, 12 False start
	13, 14 Bus error
	15, 16 Collective error
	17, 18 Power supply

Fire fighting

Fire extinguishing systems

Series description Wilo-SiFire EN

Terminal diagram

Diesel pump

X0

1	2
---	---

 X1

1	2
---	---

 X4

1-26

 X7

1-15

X10

1-9

X0	Mains connection, 230 V AC
X1	Heating connection, 230 V AC
	1, 2 Oil heating
X4	Digital inputs
	1, 2 Fuel tank level switch
	3, 4 Heating temperature switch
	5 Oil pressure switch
	6 Motor temperature switch
	7, 8 Freely programmable error message
	9, 10 Pump pressure switch option (NO contact)
	11, 12 Pressure switch (NO contact)
	13, 14 Float switch (NC contact)
	15 Starter pinion error
	16 Belt break
	17, 18 Oil pressure transmitter
	19, 20 Water temperature transmitter
	21, 22 Oil temperature transmitter
	23, 24 External water temperature transmitter
	25, 26 Motor speed transmitter
X7	Sensor connection
	1 Pressure switch (NO contact)
	2, 3 Interference voltage input for relay outputs 3 to 10
	4, 5 Automatic mode switched off
	6, 7 Pump is running
	8, 9 False start
	10, 11 Freely programmable error message
	12, 13 Collective error
	14, 15 Lack of fuel
X10	
	1 Positive pole, battery A
	2 Positive pole, battery B
	3 Starter power
	4, 5 GND
	6 Starter auxiliary voltage
	7, 8 Electric stop
	9 Charging current from motor

Fire fighting

Fire extinguishing systems



Series description Wilo-SiFire EN

Terminal diagram

Jockey pump

X0

L1	L2	L3	PE
----	----	----	----

 X1

1	2	3	PE
---	---	---	----

 X3

1	2
---	---

 X4

1	2
---	---

- X0 Mains connection (L1, L2, L3 to be connected to main switch)
- X1 Pump connection (DOL)
- X3 Potential-free contact
 - 1, 2 Pump error or control voltage failure
- X4 Sensor connection
 - 1, 2 Pressure switch (NO contact)

Fire fighting

Fire extinguishing systems

Technical data Wilo-SiFire EN

Selection table SiFire Electric

WILO SiFire EN E, 3-400V, 50Hz															
Model	Q _{lim}	Q/m ³ /h													
		0	5	10	15	20	23	25	30	33	35				
H/m															
SiFire-EN-32/200-177-4E	24	39	39	36	33	30	27	25	17	12					
SiFire-EN-32/200-193-5.5E	24	48	47	45	43	39	36	34	27						
SiFire-EN-32/200-205-7.5E	24	56	54	53	51	47	45	45	37						
SiFire-EN-32/200-210-7.5E	24	58	57	56	54	50	48	46	40						
		0	5	15	20	30	36	42	45	60	70	75	80	85	
SiFire-EN-32/250-210-15E	38	57	58	57	57	54	52	50	49	40	32	28			
SiFire-EN-32/250-225-18.5E	45	66	66	66	66	64	62	60	59	50	43	39	33		
SiFire-EN-32/250-235-22E	33	73	73	73	73	72	69	67	66	58	51	47	43	37	
SiFire-EN-32/250-257-30E	36	92	92	91	91	89	87	85	84	75	68	63	57	51	
		0	10	15	20	25	30	35	40	45	50	52	55	65	
SiFire-EN-40/200-180-7.5E	46	41	41	40	40	39	37	35	31	27	28	19			
SiFire-EN-40/200-195-11E	47	52	51	51	50	49	48	46	44	41	37	35	32		
SiFire-EN-40/200-200-11E	48	55	55	55	54	53	52	51	49	46	43	42	39		
SiFire-EN-40/200-210-15E	51	61	61	61	61	60	58	56	54	50	47	45	42		
		0	10	20	25	30	37	40	45	50	55	60	65	70	73
SiFire-EN-40/250-198-11E	38	53	53	52	50	49	46	44	41	39	36	32			
SiFire-EN-40/250-205-15E	49	57	57	56	55	54	51	49	46	43	40	35			
SiFire-EN-40/250-219-15E	39	66	66	64	63	61	58	56	54	51	48	44	40		
SiFire-EN-40/250-230-18.5E	43	72	72	70	69	67	64	62	60	57	54	50	46	40	
SiFire-EN-40/250-235-18.5E	42	75	75	73	71	69	66	65	62	60	56	53	48	43	
SiFire-EN-40/250-248-22E	46	84	82	81	80	79	75	74	71	68	64	61	57	52	47
		0	10	20	30	40	50	55	65	70	80	90	100	110	120
SiFire-EN-50/160-150-7.5E	49	29	31	31	30	29	27	26	24	23	20	17	13		
SiFire-EN-50/160-154-7.5E	55	32	32	32	32	31	29	28	26	24	21	18	15		
SiFire-EN-50/160-170-11E	70	40	40	40	39	38	37	36	33	32	29	26	23	19	
		0	10	20	30	40	50	60	65	70	75	80	85	90	100
SiFire-EN-50/200-175-11E	59	40	39	39	38	36	34	31	29	28	26	24	21		
SiFire-EN-50/200-185-15E	62	45	45	44	43	41	39	37	35	33	31	29	27	24	
SiFire-EN-50/200-195-15E	66	49	50	50	49	47	45	42	41	39	37	36	33	31	28
		0	10	20	30	40	50	60	73	80	90	100	105	110	120
SiFire-EN-50/200-204-18.5E	65	56	56	56	55	53	51	48	44	42	38	33			
SiFire-EN-50/200-208-18.5E	73	58	58	58	57	56	54	51	47	44	39	34	31		
SiFire-EN-50/200-215-22E	79	62	62	62	61	60	57	55	51	48	45	40	38	35	
		0	10	30	40	50	60	70	73	80	90	100	105	110	120
SiFire-EN-50/250-230-22E	70	72	73	73	71	69	65	60	58	55	47	39			
SiFire-EN-50/250-243-30E	73	85	85	85	83	81	78	74	72	69	63	54	49		
SiFire-EN-50/250-257-30E	75	92	92	91	90	88	86	82	80	77	71	64	59	53	

Selection limit for NPSHr = 5m. For selection above this limit, please contact the technical department.

Not suitable for HHS=High Hazard Storage (pure storage areas) and HHP=High Hazard Process (pure process areas)

Recommended minimum volume flow for diaphragm recirculation circuit 2% of the flow rate limit

Minimum NPSHr = 1m, according to standard EN12845

Technical data Wilo-SiFire EN

Selection table SiFire Electric

WILO SiFire EN E, 3-400V, 50Hz															
Model	Qlim	Q/m³/h													
		0	30	50	73	78	90	100	110	120	130	140	155	170	185
		H/m													
SiFire-EN-65/200-185-18,5E	73	41	43	43	41	41	38	35	32	29	25	21			
SiFire-EN-65/200-197-22E	78	47	48	48	47	47	45	44	42	40	37	34	27		
SiFire-EN-65/200-209-30E	84	59	61	61	59	58	56	54	52	49	46	43	37		
SiFire-EN-65/200-214-30E	107	62	63	64	62	61	59	57	55	52	49	46	41	35	
		0	50	65	90	95	100	110	130	140	150	160	175	190	200
SiFire-EN-65/250-223-30E	89	67	68	66	62	61	60	58	53	50	47	42			
SiFire-EN-65/250-240-37E	103	78	78	77	73	72	71	69	63	60	56	52			
SiFire-EN-65/250-252-45E	99	86	87	86	82	81	80	78	72	70	66	63	57		
SiFire-EN-65/250-259-55E	102	92	93	92	89	88	87	84	79	76	73	70	64	58	
		0	50	65	80	100	110	125	135	145	155	170	185	195	210
SiFire-EN-65/315-292-75E	103	108	112	113	112	109	107	104	102	99	97	93	89	87	81
		0	30	50	80	100	130	150	190	210	230	260	300	330	
SiFire-EN-80/200-192R-30E	187	47	48	48	48	47	45	43	38	35	32	26			
SiFire-EN-80/200-203-37E	211	56	55	55	53	52	51	49	45	42	39	33	23		
SiFire-EN-80/200-215.5-45E	196	60	60	61	60	60	58	57	52	50	47	41	32		
		0	30	55	80	100	130	150	180	200	230	275	300	350	
SiFire-EN-80/250-235-55E	275	69	70	71	71	70	69	68	65	62	57	48	42		
SiFire-EN-80/250-243-75E	271	77	77	77	77	76	75	74	71	69	65	56	50		
SiFire-EN-80/250-253-75E	270	84	85	85	85	84	83	82	80	77	74	66	61		
SiFire-EN-80/250-266-90E	278	95	95	95	95	94	94	93	91	90	86	80	75		
		0	40	70	110	130	150	170	205	240	280	315	350	380	400
SiFire-EN-80/315-290-110E	208	107	108	109	109	108	107	105	100	94	86	78	69	60	55
SiFire-EN-80/315-311-132E	198	128	128	128	127	126	125	124	120	116	108	100	89	78	
		0	100	150	170	200	225	250	275	300	359	366	377	387	420
SiFire-EN-100/200-168R-22E	354	32	31	29	28	26	25	23	20	17	8	7	5	2	
SiFire-EN-100/200-183-30E	359	39	38	36	35	33	32	30	28	25	15	13	10	5	
SiFire-EN-100/200-194-37E	366	45	45	43	42	41	40	38	36	34	23	22	20	14	
SiFire-EN-100/200-205-45E	377	50	50	48	48	47	46	44	43	40	30	28	26	21	
SiFire-EN-100/200-219-55E	387	59	59	58	57	57	55	54	52	49	41	40	39	36	
		0	50	100	150	200	250	275	300	350	375	400	450	475	495
SiFire-EN-100/250-233-55E	348	65	65	64	62	59	54	51	47	38	32	27	15	9	
SiFire-EN-100/250-247-75E	375	76	75	75	74	71	67	64	61	52	47	42	31	25	
SiFire-EN-100/250-256-90E	383	84	83	83	81	79	75	72	69	62	57	52	41	35	
SiFire-EN-100/250-269-110E	380	93	92	91	90	88	85	83	80	74	70	65	54	48	
		0	60	110	150	180	210	240	270	300	340	370	430	500	550
SiFire-EN-100/315-272-132E	347	94	95	97	97	97	96	94	92	89	84	80	71	60	51
SiFire-EN-100/315-294-160E	370	113	113	113	112	112	111	110	108	106	103	100	92	80	69
		0	60	130	160	200	230	260	300	340	370	450	520	580	630
SiFire-EN-125/250-224-90E	223	61	61	60	59	58	58	57	55	54	52	48	42	37	32
SiFire-EN-125/250-237-110E	258	70	69	69	69	68	67	66	65	64	63	59	54	49	43
SiFire-EN-125/250-251-132E	297	79	79	79	79	78	78	77	76	75	74	70	66	62	56
SiFire-EN-125/250-267-160E	343	90	90	90	90	90	90	90	89	88	87	84	80	75	70
		0	70	150	190	220	260	300	330	380	475	510	590	660	730
SiFire-EN-125/315-290-160E	373	103	104	103	102	101	99	96	94	90	80	76	65	53	38
		0	100	200	300	350	400	450	500	550	600	750	900	1000	1100
SiFire-EN-150/315-273-200E	431	89	89	89	89	88	86	84	82	80	76	64	49	35	
SiFire-EN-150/315-279-250E	537	94	94	94	94	93	91	89	87	84	81	70	55	43	
SiFire-EN-150/315-291-250E	756	103	103	103	102	101	100	98	96	94	91	81	67	56	40

Selection limit for NPSHr = 5m. For selection above this limit, please contact the technical department.

Not suitable for HHS=High Hazard Storage (pure storage areas) and HHP=High Hazard Process (pure process areas)

Recommended minimum volume flow for diaphragm recirculation circuit 2% of the flow rate limit

Minimum NPSHr = 1m, according to standard EN12845

Fire fighting

Fire extinguishing systems

Technical data Wilo-SiFire EN

Selection table SiFire Diesel

WILO SiFire EN D, 3-400V, 50Hz															
Model	Q _{lim}	Q/m ³ /h													
		0	5	10	15	20	23	25	30	33	35				
		H/m													
SiFire-EN-32/200-177-4.25D	24	39	39	36	33	30	27	25	17	12					
SiFire-EN-32/200-193-6.8D	24	48	47	45	43	39	36	34	27						
SiFire-EN-32/200-205-6.8D	24	56	54	53	51	47	45	45	37						
SiFire-EN-32/200-210-10.5D	24	58	57	56	54	50	48	46	40						
		0	5	15	20	30	36	42	45	60	70	75	80	85	
SiFire-EN-32/250-210-17.7D	38	57	58	57	57	54	52	50	49	40	32	28			
SiFire-EN-32/250-225-26.5D	45	66	66	66	66	64	62	60	59	50	43	39	33		
SiFire-EN-32/250-235-26.5D	33	73	73	73	73	72	69	67	66	58	51	47	43	37	
SiFire-EN-32/250-257-31.5D	36	92	92	91	91	89	87	85	84	75	68	63	57	51	
		0	10	15	20	25	30	35	40	45	50	52	55	65	
SiFire-EN-40/200-180-10.5D	46	41	41	40	40	39	37	35	31	27	28	19			
SiFire-EN-40/200-195-10.5D	47	52	51	51	50	49	48	46	44	41	37	35	32		
SiFire-EN-40/200-200-12.9D	48	55	55	55	54	53	52	51	49	46	43	42	39		
SiFire-EN-40/200-210-12.9D	51	61	61	61	61	60	58	56	54	50	47	45	42		
		0	10	20	25	30	37	40	45	50	55	60	65	70	73
SiFire-EN-40/250-198-12.9D	38	53	53	52	50	49	46	44	41	39	36	32			
SiFire-EN-40/250-205-12.9D	49	57	57	56	55	54	51	49	46	43	40	35			
SiFire-EN-40/250-219-17.7D	39	66	66	64	63	61	58	56	54	51	48	44	40		
SiFire-EN-40/250-230-17.7D	43	72	72	70	69	67	64	62	60	57	54	50	46	40	
SiFire-EN-40/250-235-26.5D	42	75	75	73	71	69	66	65	62	60	56	53	48	43	
SiFire-EN-40/250-248-26.5D	46	84	82	81	80	79	75	74	71	68	64	61	57	52	47
		0	10	20	30	40	50	55	65	70	80	90	100	110	120
SiFire-EN-50/160-150-6.8D	49	29	31	31	30	29	27	26	24	23	20	17	13		
SiFire-EN-50/160-154-10.5D	55	32	32	32	32	31	29	28	26	24	21	18	15		
SiFire-EN-50/160-170-12.9D	70	40	40	40	39	38	37	36	33	32	29	26	23	19	
		0	10	20	30	40	50	60	65	70	75	80	85	90	100
SiFire-EN-50/200-175-12.9D	59	40	39	39	38	36	34	31	29	28	26	24	21		
SiFire-EN-50/200-185-12.9D	62	45	45	44	43	41	39	37	35	33	31	29	27	24	
SiFire-EN-50/200-195-17.7D	66	49	50	50	49	47	45	42	41	39	37	36	33	31	28
		0	10	20	30	40	50	60	73	80	90	100	105	110	120
SiFire-EN-50/200-204-17.7D	65	56	56	56	55	53	51	48	44	42	38	33			
SiFire-EN-50/200-208-26.5D	73	58	58	58	57	56	54	51	47	44	39	34	31		
SiFire-EN-50/200-215-26.5D	79	62	62	62	61	60	57	55	51	48	45	40	38	35	
		0	10	30	40	50	60	70	73	80	90	100	105	110	120
SiFire-EN-50/250-230-26.5D	70	72	73	73	71	69	65	60	58	55	47	39			
SiFire-EN-50/250-243-26.5D	73	85	85	85	83	81	78	74	72	69	63	54	49		
SiFire-EN-50/250-257-31.5D	75	92	92	91	90	88	86	82	80	77	71	64	59	53	

Selection limit for NPSH_r = 5m. For selection above this limit, please contact the technical department.

Not suitable for HHS=High Hazard Storage (pure storage areas) and HHP=High Hazard Process (pure process areas)

Recommended minimum volume flow for diaphragm recirculation circuit 2% of the flow rate limit

Minimum NPSH_r = 1m, according to standard EN12845

Technical data Wilo-SiFire EN

Selection table SiFire Diesel

WILO SiFire EN D, 3-400V, 50Hz															
Model	Qlim	Q/m³/h													
		0	30	50	73	78	90	100	110	120	130	140	155	170	185
		H/m													
SiFire-EN-65/200-185-17.7D	73	41	43	43	41	41	38	35	32	29	25	21			
SiFire-EN-65/200-197-26.5D	78	47	48	48	47	47	45	44	42	40	37	34	27		
SiFire-EN-65/200-209-26.5D	84	59	61	61	59	58	56	54	52	49	46	43	37		
SiFire-EN-65/200-214-31.5D	107	62	63	64	62	61	59	57	55	52	49	46	41	35	
		0	50	65	90	95	100	110	130	140	150	160	175	190	200
SiFire-EN-65/250-223-31.5D	89	67	68	66	62	61	60	58	53	50	47	42			
SiFire-EN-65/250-240-47.7D	103	78	78	77	73	72	71	69	63	60	56	52			
SiFire-EN-65/250-252-47.7D	99	86	87	86	82	81	80	78	72	70	66	63	57		
SiFire-EN-65/250-259-66D	102	92	93	92	89	88	87	84	79	76	73	70	64	58	
		0	50	65	80	100	110	125	135	145	155	170	185	195	210
SiFire-EN-65/315-292-100D	103	108	112	113	112	109	107	104	102	99	97	93	89	87	81
		0	30	50	80	100	130	150	190	210	230	260	300	330	
SiFire-EN-80/200-192R-31.5D	187	47	48	48	48	47	45	43	38	35	32	26			
SiFire-EN-80/200-203-47.7D	211	56	55	55	53	52	51	49	45	42	39	33	23		
SiFire-EN-80/200-215.5-47.7D	196	60	60	61	60	60	58	57	52	50	47	41	32		
		0	30	55	80	100	130	150	180	200	230	275	300	350	
SiFire-EN-80/250-235-66D	275	69	70	71	71	70	69	68	65	62	57	48	42		
SiFire-EN-80/250-243-66D	271	77	77	77	77	76	75	74	71	69	65	56	50		
SiFire-EN-80/250-253-100D	270	84	85	85	85	84	83	82	80	77	74	66	61		
SiFire-EN-80/250-266-100D	278	95	95	95	95	94	94	93	91	90	86	80	75		
		0	40	70	110	130	150	170	205	240	280	315	350	380	400
SiFire-EN-80/315-290-109D	208	107	108	109	109	108	107	105	100	94	86	78	69	60	55
SiFire-EN-80/315-311-145D	198	128	128	128	127	126	125	124	120	116	108	100	89	78	
		0	100	150	170	200	225	250	275	300	359	366	377	387	420
SiFire-EN-100/200-168R-26.5D	354	32	31	29	28	26	25	23	20	17	8	7	5	2	
SiFire-EN-100/200-183-31.5D	359	39	38	36	35	33	32	30	28	25	15	13	10	5	
SiFire-EN-100/200-194-47.7D	366	45	45	43	42	41	40	38	36	34	23	22	20	14	
SiFire-EN-100/200-205-47.7D	377	50	50	48	48	47	46	44	43	40	30	28	26	21	
SiFire-EN-100/200-219-66D	387	59	59	58	57	57	55	54	52	49	41	40	39	36	
		0	50	100	150	200	250	275	300	350	375	400	450	475	495
SiFire-EN-100/250-233-66D	348	65	65	64	62	59	54	51	47	38	32	27	15	9	
SiFire-EN-100/250-247-100D	375	76	75	75	74	71	67	64	61	52	47	42	31	25	
SiFire-EN-100/250-256-100D	383	84	83	83	81	79	75	72	69	62	57	52	41	35	
SiFire-EN-100/250-269-109D	380	93	92	91	90	88	85	83	80	74	70	65	54	48	
		0	60	110	150	180	210	240	270	300	340	370	430	500	550
SiFire-EN-100/315-272-145D	347	94	95	97	97	97	96	94	92	89	84	80	71	60	51
SiFire-EN-100/315-294-197D	370	113	113	113	112	112	111	110	108	106	103	100	92	80	69
		0	60	130	160	200	230	260	300	340	370	450	520	580	630
SiFire-EN-125/250-224-100D	223	61	61	60	59	58	58	57	55	54	52	48	42	37	32
SiFire-EN-125/250-237-109D	258	70	69	69	69	68	67	66	65	64	63	59	54	49	43
SiFire-EN-125/250-251-145D	297	79	79	79	79	78	78	77	76	75	74	70	66	62	56
SiFire-EN-125/250-267-197D	343	90	90	90	90	90	90	90	89	88	87	84	80	75	70
		0	70	150	190	220	260	300	330	380	475	510	590	660	730
SiFire-EN-125/315-290-197D	373	103	104	103	102	101	99	96	94	90	80	76	65	53	38
		0	100	200	300	350	400	450	500	550	600	750	900	1000	1100
SiFire-EN-150/315-273-222D	431	89	89	89	89	88	86	84	82	80	76	64	49	35	
SiFire-EN-150/315-279-222D	537	94	94	94	94	93	91	89	87	84	81	70	55	43	
SiFire-EN-150/315-291-246D	756	103	103	103	102	101	100	98	96	94	91	81	67	56	40

Selection limit for NPSHr = 5m. For selection above this limit, please contact the technical department.

Not suitable for HHS=High Hazard Storage (pure storage areas) and HHP=High Hazard Process (pure process areas)

Recommended minimum volume flow for diaphragm recirculation circuit 2% of the flow rate limit

Minimum NPSHr = 1m, according to standard EN12845

Fire fighting

Fire extinguishing systems

Technical data Wilo-SiFire EN

Selection table SiFire Electric, Jockey

WILO SiFire EN EJ, 3-400V, 50Hz																
Model	Q _{lim}	Q/m ³ /h														
		0	5	10	15	20	23	25	30	33	35					
		H/m														
SiFire-EN-32/200-177-4/0.55EJ	24	39	39	36	33	30	27	25	17	12						
SiFire-EN-32/200-193-5.5/0.55EJ	24	48	47	45	43	39	36	34	27							
SiFire-EN-32/200-205-7.5/0.75EJ	24	56	54	53	51	47	45	45	37							
SiFire-EN-32/200-210-7.5/0.75EJ	24	58	57	56	54	50	48	46	40							
		0	5	15	20	30	36	42	45	60	70	75	80	85		
SiFire-EN-32/250-210-15/1.1EJ	38	57	58	57	57	54	52	50	49	40	32	28				
SiFire-EN-32/250-225-18.5/1.1EJ	45	66	66	66	66	64	62	60	59	50	43	39	33			
SiFire-EN-32/250-235-22/1.1EJ	33	73	73	73	73	72	69	67	66	58	51	47	43	37		
SiFire-EN-32/250-257-30/1.1EJ	36	92	92	91	91	89	87	85	84	75	68	63	57	51		
		0	10	15	20	25	30	35	40	45	50	52	55	65		
SiFire-EN-40/200-180-7.5/0.55EJ	46	41	41	40	40	39	37	35	31	27	28	19				
SiFire-EN-40/200-195-11/0.75EJ	47	52	51	51	50	49	48	46	44	41	37	35	32			
SiFire-EN-40/200-200-11/0.75EJ	48	55	55	55	54	53	52	51	49	46	43	42	39			
SiFire-EN-40/200-210-15/1.1EJ	51	61	61	61	61	60	58	56	54	50	47	45	42			
		0	10	20	25	30	37	40	45	50	55	60	65	70	73	
SiFire-EN-40/250-198-11/0.75EJ	38	53	53	52	50	49	46	44	41	39	36	32				
SiFire-EN-40/250-205-15/1.1EJ	49	57	57	56	55	54	51	49	46	43	40	35				
SiFire-EN-40/250-219-15/1.1EJ	39	66	66	64	63	61	58	56	54	51	48	44	40			
SiFire-EN-40/250-230-18.5/1.1EJ	43	72	72	70	69	67	64	62	60	57	54	50	46	40		
SiFire-EN-40/250-235-18.5/1.1EJ	42	75	75	73	71	69	66	65	62	60	56	53	48	43		
SiFire-EN-40/250-248-22/1.1EJ	46	84	82	81	80	79	75	74	71	68	64	61	57	52	47	
		0	10	20	30	40	50	55	65	70	80	90	100	110	120	
SiFire-EN-50/160-150-7.5/0.55EJ	49	29	31	31	30	29	27	26	24	23	20	17	13			
SiFire-EN-50/160-154-7.5/0.55EJ	55	32	32	32	32	31	29	28	26	24	21	18	15			
SiFire-EN-50/160-170-11/0.55EJ	70	40	40	40	39	38	37	36	33	32	29	26	23	19		
		0	10	20	30	40	50	60	65	70	75	80	85	90	100	
SiFire-EN-50/200-175-11/0.55EJ	59	40	39	39	38	36	34	31	29	28	26	24	21			
SiFire-EN-50/200-185-15/0.75EJ	62	45	45	44	43	41	39	37	35	33	31	29	27	24		
SiFire-EN-50/200-195-15/1.1EJ	66	49	50	50	49	47	45	42	41	39	37	36	33	31	28	
		0	10	20	30	40	50	60	73	80	90	100	105	110	120	
SiFire-EN-50/200-204-18.5/0.55EJ	65	56	56	56	55	53	51	48	44	42	38	33				
SiFire-EN-50/200-208-18.5/0.75EJ	73	58	58	58	57	56	54	51	47	44	39	34	31			
SiFire-EN-50/200-215-22/1.1EJ	79	62	62	62	61	60	57	55	51	48	45	40	38	35		
		0	10	30	40	50	60	70	73	80	90	100	105	110	120	
SiFire-EN-50/250-230-22/1.1EJ	70	72	73	73	71	69	65	60	58	55	47	39				
SiFire-EN-50/250-243-30/1.1EJ	73	85	85	85	83	81	78	74	72	69	63	54	49			
SiFire-EN-50/250-257-30/1.1EJ	75	92	92	91	90	88	86	82	80	77	71	64	59	53		

Selection limit for NPSH_r = 5m. For selection above this limit, please contact the technical department.

Not suitable for HHS=High Hazard Storage (pure storage areas) and HHP=High Hazard Process (pure process areas)

Recommended minimum volume flow for diaphragm recirculation circuit 2% of the flow rate limit

Minimum NPSH_r = 1m, according to standard EN12845

Technical data Wilo-SiFire EN

Selection table SiFire Electric, Jockey

WILO SiFire EN EJ, 3-400V, 50Hz															
Model	Qlim	Q/m³/h													
		0	30	50	73	78	90	100	110	120	130	140	155	170	185
		H/m													
SiFire-EN-65/200-185-18,5/0.55EJ	73	41	43	43	41	41	38	35	32	29	25	21			
SiFire-EN-65/200-197-22/0.75EJ	78	47	48	48	47	47	45	44	42	40	37	34	27		
SiFire-EN-65/200-209-30/1.1EJ	84	59	61	61	59	58	56	54	52	49	46	43	37		
SiFire-EN-65/200-214-30/1.1EJ	107	62	63	64	62	61	59	57	55	52	49	46	41	35	
		0	50	65	90	95	100	110	130	140	150	160	175	190	200
SiFire-EN-65/250-223-30/1.1EJ	89	67	68	66	62	61	60	58	53	50	47	42			
SiFire-EN-65/250-240-37/1.1EJ	103	78	78	77	73	72	71	69	63	60	56	52			
SiFire-EN-65/250-252-45/1.1EJ	99	86	87	86	82	81	80	78	72	70	66	63	57		
SiFire-EN-65/250-259-55/1.1EJ	102	92	93	92	89	88	87	84	79	76	73	70	64	58	
		0	50	65	80	100	110	125	135	145	155	170	185	195	210
SiFire-EN-65/315-292-75/1.5EJ	103	108	112	113	112	109	107	104	102	99	97	93	89	87	81
		0	30	50	80	100	130	150	190	210	230	260	300	330	
SiFire-EN-80/200-192R-30/0.75EJ	187	47	48	48	48	47	45	43	38	35	32	26			
SiFire-EN-80/200-203-37/1.1EJ	211	56	55	55	53	52	51	49	45	42	39	33	23		
SiFire-EN-80/200-215.5-45/1.1EJ	196	60	60	61	60	60	58	57	52	50	47	41	32		
		0	30	55	80	100	130	150	180	200	230	275	300	350	
SiFire-EN-80/250-235-55/1.1EJ	275	69	70	71	71	70	69	68	65	62	57	48	42		
SiFire-EN-80/250-243-75/1.1EJ	271	77	77	77	77	76	75	74	71	69	65	56	50		
SiFire-EN-80/250-253-75/1.1EJ	270	84	85	85	85	84	83	82	80	77	74	66	61		
SiFire-EN-80/250-266-90/1.1EJ	278	95	95	95	95	94	94	93	91	90	86	80	75		
		0	40	70	110	130	150	170	205	240	280	315	350	380	400
SiFire-EN-80/315-290-110/1.5EJ	208	107	108	109	109	108	107	105	100	94	86	78	69	60	55
SiFire-EN-80/315-311-132/1.5EJ	198	128	128	128	127	126	125	124	120	116	108	100	89	78	
		0	100	150	170	200	225	250	275	300	359	366	377	387	420
SiFire-EN-100/200-168R-22/0.55EJ	354	32	31	29	28	26	25	23	20	17	8	7	5	2	
SiFire-EN-100/200-183-30/0.55EJ	359	39	38	36	35	33	32	30	28	25	15	13	10	5	
SiFire-EN-100/200-194-37/0.75EJ	366	45	45	43	42	41	40	38	36	34	23	22	20	14	
SiFire-EN-100/200-205-45/0.75EJ	377	50	50	48	48	47	46	44	43	40	30	28	26	21	
SiFire-EN-100/200-219-55/1.1EJ	387	59	59	58	57	57	55	54	52	49	41	40	39	36	
		0	50	100	150	200	250	275	300	350	375	400	450	475	495
SiFire-EN-100/250-233-55/1.1EJ	348	65	65	64	62	59	54	51	47	38	32	27	15	9	
SiFire-EN-100/250-247-75/1.1EJ	375	76	75	75	74	71	67	64	61	52	47	42	31	25	
SiFire-EN-100/250-256-90/1.1EJ	383	84	83	83	81	79	75	72	69	62	57	52	41	35	
SiFire-EN-100/250-269-110/1.1EJ	380	93	92	91	90	88	85	83	80	74	70	65	54	48	
		0	60	110	150	180	210	240	270	300	340	370	430	500	550
SiFire-EN-100/315-272-132/1.5EJ	347	94	95	97	97	97	96	94	92	89	84	80	71	60	51
SiFire-EN-100/315-294-160/1.5EJ	370	113	113	113	112	112	111	110	108	106	103	100	92	80	69
		0	60	130	160	200	230	260	300	340	370	450	520	580	630
SiFire-EN-125/250-224-90/1.1EJ	223	61	61	60	59	58	58	57	55	54	52	48	42	37	32
SiFire-EN-125/250-237-110/1.1EJ	258	70	69	69	69	68	67	66	65	64	63	59	54	49	43
SiFire-EN-125/250-251-132/1.1EJ	297	79	79	79	79	78	78	77	76	75	74	70	66	62	56
SiFire-EN-125/250-267-160/1.1EJ	343	90	90	90	90	90	90	90	89	88	87	84	80	75	70
		0	70	150	190	220	260	300	330	380	475	510	590	660	730
SiFire-EN-125/315-290-160/1.1EJ	373	103	104	103	102	101	99	96	94	90	80	76	65	53	38
		0	100	200	300	350	400	450	500	550	600	750	900	1000	1100
SiFire-EN-150/315-273-200/1.1EJ	431	89	89	89	89	88	86	84	82	80	76	64	49	35	
SiFire-EN-150/315-279-250/1.1EJ	537	94	94	94	94	93	91	89	87	84	81	70	55	43	
SiFire-EN-150/315-291-250/1.1EJ	756	103	103	103	102	101	100	98	96	94	91	81	67	56	40

Selection limit for NPSHr = 5m. For selection above this limit, please contact the technical department.

Not suitable for HHS=High Hazard Storage (pure storage areas) and HHP=High Hazard Process (pure process areas)

Recommended minimum volume flow for diaphragm recirculation circuit 2% of the flow rate limit

Minimum NPSHr = 1m, according to standard EN12845

Fire fighting

Fire extinguishing systems

Technical data Wilo-SiFire EN

Selection table SiFire Diesel, Jockey

WILO SiFire EN DJ, 3-400V, 50Hz															
Model	Qlim	Q/m ³ /h													
		0	5	10	15	20	23	25	30	33	35				
		H/m													
SiFire-EN-32/200-177-4.25/0.55DJ	24	39	39	36	33	30	27	25	17	12					
SiFire-EN-32/200-193-6.8/0.55DJ	24	48	47	45	43	39	36	34	27						
SiFire-EN-32/200-205-6.8/0.75DJ	24	56	54	53	51	47	45	45	37						
SiFire-EN-32/200-210-10.5/0.75DJ	24	58	57	56	54	50	48	46	40						
		0	5	15	20	30	36	42	45	60	70	75	80	85	
SiFire-EN-32/250-210-17.7/1.1DJ	38	57	58	57	57	54	52	50	49	40	32	28			
SiFire-EN-32/250-225-26.5/1.1DJ	45	66	66	66	66	64	62	60	59	50	43	39	33		
SiFire-EN-32/250-235-26.5/1.1DJ	33	73	73	73	73	72	69	67	66	58	51	47	43	37	
SiFire-EN-32/250-257-31.5/1.1DJ	36	92	92	91	91	89	87	85	84	75	68	63	57	51	
		0	10	15	20	25	30	35	40	45	50	52	55	65	
SiFire-EN-40/200-180-10.5/0.55DJ	46	41	41	40	40	39	37	35	31	27	28	19			
SiFire-EN-40/200-195-10.5/0.75DJ	47	52	51	51	50	49	48	46	44	41	37	35	32		
SiFire-EN-40/200-200-12.9/0.75DJ	48	55	55	55	54	53	52	51	49	46	43	42	39		
SiFire-EN-40/200-210-12.9/1.1DJ	51	61	61	61	61	60	58	56	54	50	47	45	42		
		0	10	20	25	30	37	40	45	50	55	60	65	70	73
SiFire-EN-40/250-198-12.9/0.75DJ	38	53	53	52	50	49	46	44	41	39	36	32			
SiFire-EN-40/250-205-12.9/1.1DJ	49	57	57	56	55	54	51	49	46	43	40	35			
SiFire-EN-40/250-219-17.7/1.1DJ	39	66	66	64	63	61	58	56	54	51	48	44	40		
SiFire-EN-40/250-230-17.7/1.1DJ	43	72	72	70	69	67	64	62	60	57	54	50	46	40	
SiFire-EN-40/250-235-26.5/1.1DJ	42	75	75	73	71	69	66	65	62	60	56	53	48	43	
SiFire-EN-40/250-248-26.5/1.1DJ	46	84	82	81	80	79	75	74	71	68	64	61	57	52	47
		0	10	20	30	40	50	55	65	70	80	90	100	110	120
SiFire-EN-50/200-175-12.9/0.55DJ	49	29	31	31	30	29	27	26	24	23	20	17	13		
SiFire-EN-50/200-185-12.9/0.75DJ	55	32	32	32	32	31	29	28	26	24	21	18	15		
SiFire-EN-50/200-195-17.7/1.1DJ	70	40	40	40	39	38	37	36	33	32	29	26	23	19	
		0	10	20	30	40	50	60	65	70	75	80	85	90	100
SiFire-EN-50/200-204-17.7/1.1DJ	59	40	39	39	38	36	34	31	29	28	26	24	21		
SiFire-EN-50/200-208-26.5/1.1DJ	62	45	45	44	43	41	39	37	35	33	31	29	27	24	
SiFire-EN-50/200-215-26.5/1.1DJ	66	49	50	50	49	47	45	42	41	39	37	36	33	31	28
		0	10	20	30	40	50	60	73	80	90	100	105	110	120
SiFire-EN-50/250-230-26.5/1.1DJ	65	56	56	56	55	53	51	48	44	42	38	33			
SiFire-EN-50/250-243-26.5/1.1DJ	73	58	58	58	57	56	54	51	47	44	39	34	31		
SiFire-EN-50/250-257-31.5/1.1DJ	79	62	62	62	61	60	57	55	51	48	45	40	38	35	
		0	10	30	40	50	60	70	73	80	90	100	105	110	120
SiFire-EN-50/250-230-26.5/1.1DJ	70	72	73	73	71	69	65	60	58	55	47	39			
SiFire-EN-50/250-243-26.5/1.1DJ	73	85	85	85	83	81	78	74	72	69	63	54	49		
SiFire-EN-50/250-257-31.5/1.1DJ	75	92	92	91	90	88	86	82	80	77	71	64	59	53	

Selection limit for NPSHr = 5m. For selection above this limit, please contact the technical department.

Not suitable for HHS=High Hazard Storage (pure storage areas) and HHP=High Hazard Process (pure process areas)

Recommended minimum volume flow for diaphragm recirculation circuit 2% of the flow rate limit

Minimum NPSHr = 1m, according to standard EN12845

Technical data Wilo-SiFire EN

Selection table SiFire Diesel, Jockey

WILO SiFire EN DJ, 3-400V, 50Hz															
Model	Qlim	Q/m³/h													
		0	30	50	73	78	90	100	110	120	130	140	155	170	185
		H/m													
SiFire-EN-65/200-185-17.7/0.55DJ	73	41	43	43	41	41	38	35	32	29	25	21			
SiFire-EN-65/200-197-26.5/0.75DJ	78	47	48	48	47	47	45	44	42	40	37	34	27		
SiFire-EN-65/200-209-26.5/1.1DJ	84	59	61	61	59	58	56	54	52	49	46	43	37		
SiFire-EN-65/200-214-31.5/1.1DJ	107	62	63	64	62	61	59	57	55	52	49	46	41	35	
		0	50	65	90	95	100	110	130	140	150	160	175	190	200
SiFire-EN-65/250-223-31.5/1.1DJ	89	67	68	66	62	61	60	58	53	50	47	42			
SiFire-EN-65/250-240-47.7/1.1DJ	103	78	78	77	73	72	71	69	63	60	56	52			
SiFire-EN-65/250-252-47.7/1.1DJ	99	86	87	86	82	81	80	78	72	70	66	63	57		
SiFire-EN-65/250-259-66/1.1DJ	102	92	93	92	89	88	87	84	79	76	73	70	64	58	
		0	50	65	80	100	110	125	135	145	155	170	185	195	210
Sifire-EN-65/315-292-100/1,5DJ	103	108	112	113	112	109	107	104	102	99	97	93	89	87	81
		0	30	50	80	100	130	150	190	210	230	260	300	330	
SiFire-EN-80/200-192R-31.5/0.75DJ	187	47	48	48	48	47	45	43	38	35	32	26			
SiFire-EN-80/200-203-47.7/1.1DJ	211	56	55	55	53	52	51	49	45	42	39	33	23		
SiFire-EN-80/200-215.5-47.7/1.1DJ	196	60	60	61	60	60	58	57	52	50	47	41	32		
		0	30	55	80	100	130	150	180	200	230	275	300	350	
SiFire-EN-80/250-235-66/1.1 J	275	69	70	71	71	70	69	68	65	62	57	48	42		
Sifire-EN-80/250-243-66/1,1DJ	271	77	77	77	77	76	75	74	71	69	65	56	50		
Sifire-EN-80/250-253-100/1,1DJ	270	84	85	85	85	84	83	82	80	77	74	66	61		
Sifire-EN-80/250-266-100/1,1DJ	278	95	95	95	95	94	94	93	91	90	86	80	75		
		0	40	70	110	130	150	170	205	240	280	315	350	380	400
Sifire-EN-80/315-290-109/1,5DJ	208	107	108	109	109	108	107	105	100	94	86	78	69	60	55
Sifire-EN-80/315-311-145/1,5DJ	198	128	128	128	127	126	125	124	120	116	108	100	89	78	
		0	100	150	170	200	225	250	275	300	359	366	377	387	420
SiFire-EN-100/200-168R-26.5/0.55DJ	354	32	31	29	28	26	25	23	20	17	8	7	5	2	
SiFire-EN-100/200-183-31.5/0.55DJ	359	39	38	36	35	33	32	30	28	25	15	13	10	5	
SiFire-EN-100/200-194-47.7/0.75DJ	366	45	45	43	42	41	40	38	36	34	23	22	20	14	
SiFire-EN-100/200-205-47.7/0.75DJ	377	50	50	48	48	47	46	44	43	40	30	28	26	21	
SiFire-EN-100/200-219-66/1.1DJ	387	59	59	58	57	57	55	54	52	49	41	40	39	36	
		0	50	100	150	200	250	275	300	350	375	400	450	475	495
SiFire-EN-100/250-233-66/1.1DJ	348	65	65	64	62	59	54	51	47	38	32	27	15	9	
Sifire-EN-100/250-247-100/1,1DJ	375	76	75	75	74	71	67	64	61	52	47	42	31	25	
Sifire-EN-100/250-256-100/1,1DJ	383	84	83	83	81	79	75	72	69	62	57	52	41	35	
Sifire-EN-100/250-269-109/1,1DJ	380	93	92	91	90	88	85	83	80	74	70	65	54	48	
		0	60	110	150	180	210	240	270	300	340	370	430	500	550
Sifire-EN-100/315-272-145/1,5DJ	347	94	95	97	97	97	96	94	92	89	84	80	71	60	51
Sifire-EN-100/315-294-197/1,5DJ	370	113	113	113	112	112	111	110	108	106	103	100	92	80	69
		0	60	130	160	200	230	260	300	340	370	450	520	580	630
Sifire-EN-125/250-224-100/1,1DJ	223	61	61	60	59	58	58	57	55	54	52	48	42	37	32
Sifire-EN-125/250-237-109/1,1DJ	258	70	69	69	69	68	67	66	65	64	63	59	54	49	43
Sifire-EN-125/250-251-145/1,1DJ	297	79	79	79	79	78	78	77	76	75	74	70	66	62	56
Sifire-EN-125/250-267-197/1,1DJ	343	90	90	90	90	90	90	90	89	88	87	84	80	75	70
		0	70	150	190	220	260	300	330	380	475	510	590	660	730
Sifire-EN-125/315-290-197/1,5DJ	373	103	104	103	102	101	99	96	94	90	80	76	65	53	38
		0	100	200	300	350	400	450	500	550	600	750	900	1000	1100
Sifire-EN-150/315-273-222/1,1DJ	431	89	89	89	89	88	86	84	82	80	76	64	49	35	
Sifire-EN-150/315-279-222/1,1DJ	537	94	94	94	94	93	91	89	87	84	81	70	55	43	
Sifire-EN-150/315-291-246/1,5DJ	756	103	103	103	102	101	100	98	96	94	91	81	67	56	40

Selection limit for NPSHr = 5m. For selection above this limit, please contact the technical department.

Not suitable for HHS=High Hazard Storage (pure storage areas) and HHP=High Hazard Process (pure process areas)

Recommended minimum volume flow for diaphragm recirculation circuit 2% of the flow rate limit

Minimum NPSHr = 1m, according to standard EN12845

Fire fighting

Fire extinguishing systems

Technical data Wilo-SiFire EN

Selection table SiFire Electric, Diesel, Jockey

WILO SiFire EN EDJ, 3-400V, 50Hz															
Model	Q _{lim}	Q/m ³ /h													
		0	5	10	15	20	23	25	30	33	35				
		H/m													
SiFire-EN-32/200-177-4/4.25/0.55EDJ	24	39	39	36	33	30	27	25	17	12					
SiFire-EN-32/200-193-5.5/6.8/0.55EDJ	24	48	47	45	43	39	36	34	27						
SiFire-EN-32/200-205-7.5/6.8/0.75EDJ	24	56	54	53	51	47	45	45	37						
SiFire-EN-32/200-210-7.5/10.5/0.75EDJ	24	58	57	56	54	50	48	46	40						
		0	5	15	20	30	36	42	45	60	70	75	80	85	
SiFire-EN-32/250-210-15/17.7/1.1EDJ	38	57	58	57	57	54	52	50	49	40	32	28			
SiFire-EN-32/250-225-18.5/26.5/1.1EDJ	45	66	66	66	66	64	62	60	59	50	43	39	33		
SiFire-EN-32/250-235-22/26.5/1.1EDJ	33	73	73	73	73	72	69	67	66	58	51	47	43	37	
SiFire-EN-32/250-257-30/31.5/1.1EDJ	36	92	92	91	91	89	87	85	84	75	68	63	57	51	
		0	10	15	20	25	30	35	40	45	50	52	55	65	
SiFire-EN-40/200-180-7.5/10.5/0.55EDJ	46	41	41	40	40	39	37	35	31	27	28	19			
SiFire-EN-40/200-195-11/10.5/0.75EDJ	47	52	51	51	50	49	48	46	44	41	37	35	32		
SiFire-EN-40/200-200-11/12.9/0.75EDJ	48	55	55	55	54	53	52	51	49	46	43	42	39		
SiFire-EN-40/200-210-15/12.9/1.1EDJ	51	61	61	61	61	60	58	56	54	50	47	45	42		
		0	10	20	25	30	37	40	45	50	55	60	65	70	73
SiFire-EN-40/250-198-11/12.9/0.75EDJ	38	53	53	52	50	49	46	44	41	39	36	32			
SiFire-EN-40/250-205-15/12.9/1.1EDJ	49	57	57	56	55	54	51	49	46	43	40	35			
SiFire-EN-40/250-219-15/17.7/1.1EDJ	39	66	66	64	63	61	58	56	54	51	48	44	40		
SiFire-EN-40/250-230-18.5/17.7/1.1EDJ	43	72	72	70	69	67	64	62	60	57	54	50	46	40	
SiFire-EN-40/250-235-18.5/26.5/1.1EDJ	42	75	75	73	71	69	66	65	62	60	56	53	48	43	
SiFire-EN-40/250-248-22/26.5/1.1EDJ	46	84	82	81	80	79	75	74	71	68	64	61	57	52	47
		0	10	20	30	40	50	55	65	70	80	90	100	110	120
SiFire-EN-50/160-150-7.5/6.8/0.55EDJ	49	29	31	31	30	29	27	26	24	23	20	17	13		
SiFire-EN-50/160-154-7.5/10.5/0.55EDJ	55	32	32	32	32	31	29	28	26	24	21	18	15		
SiFire-EN-50/160-170-11/12.9/0.55EDJ	70	40	40	40	39	38	37	36	33	32	29	26	23	19	
		0	10	20	30	40	50	60	65	70	75	80	85	90	100
SiFire-EN-50/200-175-11/12.9/0.55EDJ	59	40	39	39	38	36	34	31	29	28	26	24	21		
SiFire-EN-50/200-185-15/12.9/0.75EDJ	62	45	45	44	43	41	39	37	35	33	31	29	27	24	
SiFire-EN-50/200-195-15/17.7/1.1EDJ	66	49	50	50	49	47	45	42	41	39	37	36	33	31	28
		0	10	20	30	40	50	60	73	80	90	100	105	110	120
SiFire-EN-50/200-204-18.5/17.7/1.1EDJ	65	56	56	56	55	53	51	48	44	42	38	33			
SiFire-EN-50/200-208-18.5/26.5/1.1EDJ	73	58	58	58	57	56	54	51	47	44	39	34	31		
SiFire-EN-50/200-215-22/26.5/1.1EDJ	79	62	62	62	61	60	57	55	51	48	45	40	38	35	
		0	10	30	40	50	60	70	73	80	90	100	105	110	120
SiFire-EN-50/250-230-22/26.5/1.1EDJ	70	72	73	73	71	69	65	60	58	55	47	39			
SiFire-EN-50/250-243-30/26.5/1.1EDJ	73	85	85	85	83	81	78	74	72	69	63	54	49		
SiFire-EN-50/250-257-30/31.5/1.1EDJ	75	92	92	91	90	88	86	82	80	77	71	64	59	53	

Selection limit for NPSHr = 5m. For selection above this limit, please contact the technical department.

Not suitable for HHS=High Hazard Storage (pure storage areas) and HHP=High Hazard Process (pure process areas)

Recommended minimum volume flow for diaphragm recirculation circuit 2% of the flow rate limit

Minimum NPSHr = 1m, according to standard EN12845

Technical data Wilo-SiFire EN

Selection table SiFire Electric, Diesel, Jockey

WILO SiFire EN EDJ, 3-400V, 50Hz																
Model	Q _{lim}	Q/m ³ /h														
		0	30	50	73	78	90	100	110	120	130	140	155	170	185	
		H/m														
SiFire-EN-65/200-185-18.5/17.7/0.55EDJ	73	41	43	43	41	41	38	35	32	29	25	21				
SiFire-EN-65/200-197-22/26.5/0.75EDJ	78	47	48	48	47	47	45	44	42	40	37	34	27			
SiFire-EN-65/200-209-30/26.5/1.1EDJ	84	59	61	61	59	58	56	54	52	49	46	43	37			
SiFire-EN-65/200-214-30/31.5/1.1EDJ	107	62	63	64	62	61	59	57	55	52	49	46	41	35		
		0	50	65	90	95	100	110	130	140	150	160	175	190	200	
SiFire-EN-65/250-223-30/31.5/1.1EDJ	89	67	68	66	62	61	60	58	53	50	47	42				
SiFire-EN-65/250-240-37/47.7/1.1EDJ	103	78	78	77	73	72	71	69	63	60	56	52				
SiFire-EN-65/250-252-45/47.7/1.1EDJ	99	86	87	86	82	81	80	78	72	70	66	63	57			
SiFire-EN-65/250-259-55/66/1.1EDJ	102	92	93	92	89	88	87	84	79	76	73	70	64	58		
		0	30	50	80	100	130	150	190	210	230	260	300	330		
SiFire-EN-80/200-192R-30/31.5/0.75EDJ	187	47	48	48	48	47	45	43	38	35	32	26				
SiFire-EN-80/200-203-37/47.7/1.1EDJ	211	56	55	55	53	52	51	49	45	42	39	33	23			
SiFire-EN-80/200-215,5-45/47.7/1.1EDJ	196	60	60	61	60	60	58	57	52	50	47	41	32			
		0	30	55	80	100	130	150	180	200	230	275	300	350		
SiFire-EN-80/250-235-55/66/1.1EDJ	275	69	70	71	71	70	69	68	65	62	57	48	42			
		0	100	150	170	200	225	250	275	300	359	366	377	387	420	
SiFire-EN-100/200-168R-22/26.5/0.55EDJ	354	32	31	29	28	26	25	23	20	17	8	7	5	2		
SiFire-EN-100/200-183-30/31.5/0.55EDJ	359	39	38	36	35	33	32	30	28	25	15	13	10	5		
SiFire-EN-100/200-194-37/47.7/0.75EDJ	366	45	45	43	42	41	40	38	36	34	23	22	20	14		
SiFire-EN-100/200-205-45/47.7/0.75EDJ	377	50	50	48	48	47	46	44	43	40	30	28	26	21		
SiFire-EN-100/200-219-55/66/1.1EDJ	387	59	59	58	57	57	55	54	52	49	41	40	39	36		
		0	50	100	150	200	250	275	300	350	375	400	450	475	495	
SiFire-EN-100/250-233-55/66/1.1EDJ	348	65	65	64	62	59	54	51	47	38	32	27	15	9		

Selection limit for NPSHr = 5m. For selection above this limit, please contact the technical department.

Not suitable for HHS=High Hazard Storage (pure storage areas) and HHP=High Hazard Process (pure process areas)

Recommended minimum volume flow for diaphragm recirculation circuit 2% of the flow rate limit

Minimum NPSHr = 1m, according to standard EN12845

Fire fighting

Fire extinguishing systems

Technical data Wilo-SiFire EN

Selection table SiFire Electric, Electric, Jockey

WILO SiFire EN EEJ, 3-400V, 50Hz																
Model	Q _{lim}	Q/m ³ /h														
		0	5	10	15	20	23	25	30	33	35					
H/m																
SiFire-EN-32/200-177-4/4/0.55EEJ	24	39	39	36	33	30	27	25	17	12						
SiFire-EN-32/200-193-5.5/5.5/0.55EEJ	24	48	47	45	43	39	36	34	27							
SiFire-EN-32/200-205-7.5/7.5/0.75EEJ	24	56	54	53	51	47	45	45	37							
SiFire-EN-32/200-210-7.5/7.5/0.75EEJ	24	58	57	56	54	50	48	46	40							
		0	5	15	20	30	36	42	45	60	70	75	80	85		
SiFire-EN-32/250-210-15/15/1.1EEJ	38	57	58	57	57	54	52	50	49	40	32	28				
SiFire-EN-32/250-225-18.5/18.5/1.1EEJ	45	66	66	66	66	64	62	60	59	50	43	39	33			
SiFire-EN-32/250-235-22/22/1.1EEJ	33	73	73	73	73	72	69	67	66	58	51	47	43	37		
SiFire-EN-32/250-257-30/30/1.1EEJ	36	92	92	91	91	89	87	85	84	75	68	63	57	51		
		0	10	15	20	25	30	35	40	45	50	52	55	65		
SiFire-EN-40/200-180-7.5/7.5/0.55EEJ	46	41	41	40	40	39	37	35	31	27	28	19				
SiFire-EN-40/200-195-11/11/0.75EEJ	47	52	51	51	50	49	48	46	44	41	37	35	32			
SiFire-EN-40/200-200-11/11/0.75EEJ	48	55	55	55	54	53	52	51	49	46	43	42	39			
SiFire-EN-40/200-210-15/15/1.1EEJ	51	61	61	61	61	60	58	56	54	50	47	45	42			
		0	10	20	25	30	37	40	45	50	55	60	65	70	73	
SiFire-EN-40/250-198-11/11/0.75EEJ	38	53	53	52	50	49	46	44	41	39	36	32				
SiFire-EN-40/250-205-15/15/1.1EEJ	49	57	57	56	55	54	51	49	46	43	40	35				
SiFire-EN-40/250-219-15/15/1.1EEJ	39	66	66	64	63	61	58	56	54	51	48	44	40			
SiFire-EN-40/250-230-18.5/18.5/1.1EEJ	43	72	72	70	69	67	64	62	60	57	54	50	46	40		
SiFire-EN-40/250-235-18.5/18.5/1.1EEJ	42	75	75	73	71	69	66	65	62	60	56	53	48	43		
SiFire-EN-40/250-248-22/22/1.1EEJ	46	84	82	81	80	79	75	74	71	68	64	61	57	52	47	
		0	10	20	30	40	50	55	65	70	80	90	100	110	120	
SiFire-EN-50/160-150-7.5/7.5/0.55EEJ	49	29	31	31	30	29	27	26	24	23	20	17	13			
SiFire-EN-50/160-154-7.5/7.5/0.55EEJ	55	32	32	32	32	31	29	28	26	24	21	18	15			
SiFire-EN-50/160-170-11/11/0.55EEJ	70	40	40	40	39	38	37	36	33	32	29	26	23	19		
		0	10	20	30	40	50	60	65	70	75	80	85	90	100	
SiFire-EN-50/200-175-11/11/0.55EEJ	59	40	39	39	38	36	34	31	29	28	26	24	21			
SiFire-EN-50/200-185-15/15/0.75EEJ	62	45	45	44	43	41	39	37	35	33	31	29	27	24		
SiFire-EN-50/200-195-15/15/1.1EEJ	66	49	50	50	49	47	45	42	41	39	37	36	33	31	28	
		0	10	20	30	40	50	60	73	80	90	100	105	110	120	
SiFire-EN-50/200-204-18.5/18.5/1.1EEJ	65	56	56	56	55	53	51	48	44	42	38	33				
SiFire-EN-50/200-208-18.5/18.5/1.1EEJ	73	58	58	58	57	56	54	51	47	44	39	34	31			
SiFire-EN-50/200-215-22/22/1.1EEJ	79	62	62	62	61	60	57	55	51	48	45	40	38	35		
		0	10	30	40	50	60	70	73	80	90	100	105	110	120	
SiFire-EN-50/250-230-22/22/1.1EEJ	70	72	73	73	71	69	65	60	58	55	47	39				
SiFire-EN-50/250-243-30/30/1.1EEJ	73	85	85	85	83	81	78	74	72	69	63	54	49			
SiFire-EN-50/250-257-30/30/1.1EEJ	75	92	92	91	90	88	86	82	80	77	71	64	59	53		

Selection limit for NPSH_r = 5m. For selection above this limit, please contact the technical department.

Not suitable for HHS=High Hazard Storage (pure storage areas) and HHP=High Hazard Process (pure process areas)

Recommended minimum volume flow for diaphragm recirculation circuit 2% of the flow rate limit

Minimum NPSH_r = 1m, according to standard EN12845

Technical data Wilo-SiFire EN

Selection table SiFire Electric, Electric, Jockey

WILO SiFire EN EEJ, 3-400V, 50Hz															
Model	Q _{lim}	Q/m ³ /h													
		0	30	50	73	78	90	100	110	120	130	140	155	170	185
		H/m													
SiFire-EN-65/200-185-18.5/18.5/0.55EEJ	73	41	43	43	41	41	38	35	32	29	25	21			
SiFire-EN-65/200-197-22/22/0.75EEJ	78	47	48	48	47	47	45	44	42	40	37	34	27		
SiFire-EN-65/200-209-30/30/1.1EEJ	84	59	61	61	59	58	56	54	52	49	46	43	37		
SiFire-EN-65/200-214-30/30/1.1EEJ	107	62	63	64	62	61	59	57	55	52	49	46	41	35	
		0	50	65	90	95	100	110	130	140	150	160	175	190	200
SiFire-EN-65/250-223-30/30/1.1EEJ	89	67	68	66	62	61	60	58	53	50	47	42			
SiFire-EN-65/250-240-37/37/1.1EEJ	103	78	78	77	73	72	71	69	63	60	56	52			
SiFire-EN-65/250-252-45/45/1.1EEJ	99	86	87	86	82	81	80	78	72	70	66	63	57		
SiFire-EN-65/250-259-55/55/1.1EEJ	102	92	93	92	89	88	87	84	79	76	73	70	64	58	
		0	30	50	80	100	130	150	190	210	230	260	300	330	
SiFire-EN-80/200-192R-30/30/0.75EEJ	187	47	48	48	48	47	45	43	38	35	32	26			
SiFire-EN-80/200-203-37/37/1.1EEJ	211	56	55	55	53	52	51	49	45	42	39	33	23		
SiFire-EN-80/200-215,5-45/45/1.1EEJ	196	60	60	61	60	60	58	57	52	50	47	41	32		
		0	30	55	80	100	130	150	180	200	230	275	300	350	
SiFire-EN-80/250-235-55/55/1.1EEJ	275	69	70	71	71	70	69	68	65	62	57	48	42		
		0	100	150	170	200	225	250	275	300	359	366	377	387	420
SiFire-EN-100/200-168R-22/22/0.55EEJ	354	32	31	29	28	26	25	23	20	17	8	7	5	2	
SiFire-EN-100/200-183-30/30/0.55EEJ	359	39	38	36	35	33	32	30	28	25	15	13	10	5	
SiFire-EN-100/200-194-37/37/0.75EEJ	366	45	45	43	42	41	40	38	36	34	23	22	20	14	
SiFire-EN-100/200-205-45/45/0.75EEJ	377	50	50	48	48	47	46	44	43	40	30	28	26	21	
SiFire-EN-100/200-219-55/55/1.1EEJ	387	59	59	58	57	57	55	54	52	49	41	40	39	36	
		0	50	100	150	200	250	275	300	350	375	400	450	475	495
SiFire-EN-100/250-233-55/66/1.1EEJ	348	65	65	64	62	59	54	51	47	38	32	27	15	9	

Selection limit for NPSHr = 5m. For selection above this limit, please contact the technical department.

Not suitable for HHS=High Hazard Storage (pure storage areas) and HHP=High Hazard Process (pure process areas)

Recommended minimum volume flow for diaphragm recirculation circuit 2% of the flow rate limit

Minimum NPSHr = 1m, according to standard EN12845

Fire fighting

Fire extinguishing systems

Technical data Wilo-SiFire EN

Pump curves

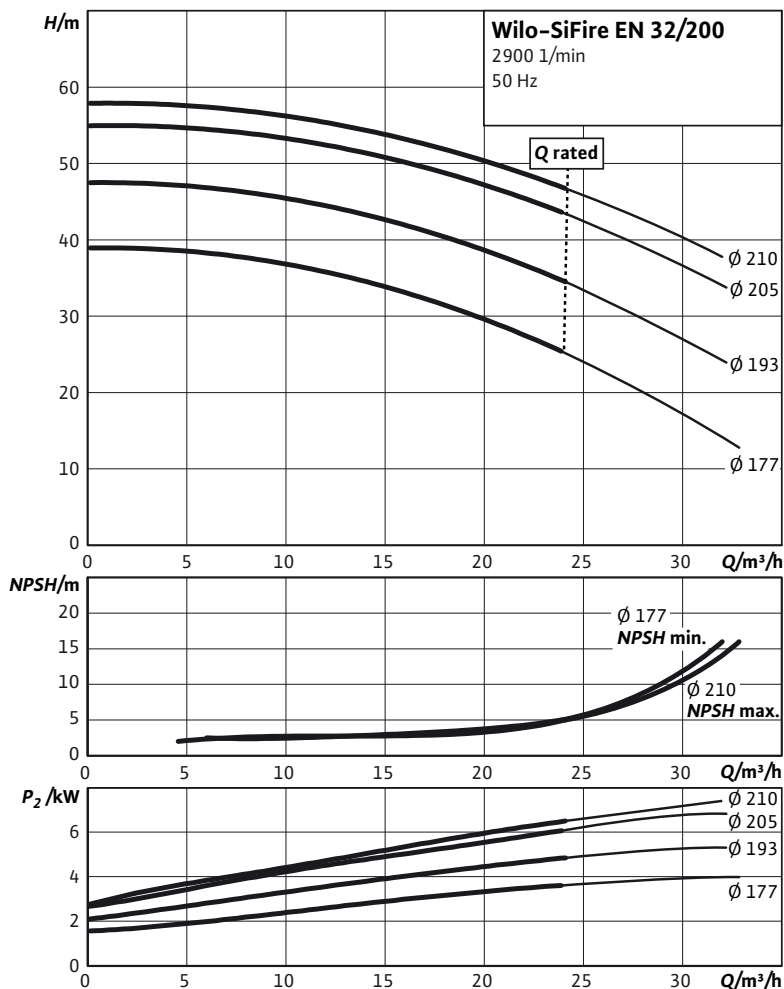

Motor data

	SiFire EN 32/200			
	177	193	205	210
Impeller mm	177	193	205	210
Electric pump				
Nominal motor power P_2 / kW	4	5.5	7.5	7.5
Nominal current 3-400 V, 50 Hz I_N / A	7.72	10.6	14.1	14.1
Diesel pump				
Nominal motor power P / kW	4.2	6.7	6.7	10.25
Jockey pump				
Nominal motor power P_2 / kW	0.55	0.55	0.75	0.75
Nominal current 3-400 V, 50 Hz I_N / A	1.8	1.8	1.83	1.83

Technical data Wilo-SiFire EN

Pump curves

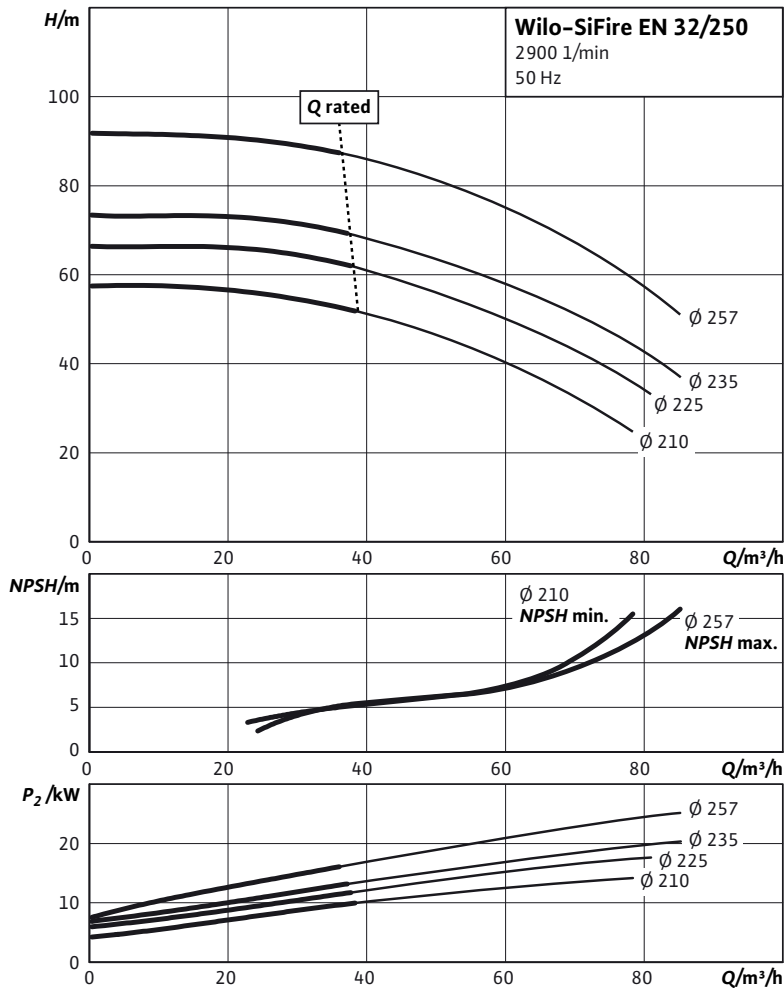

Motor data				
	SiFire EN 32/250			
Impeller mm	210	225	235	257
Electric pump				
Nominal motor power P_2 / kW	15	18.5	22	30
Nominal current 3~400 V, 50 Hz I_N / A	27.6	33.7	39.1	53.6
Diesel pump				
Nominal motor power P / kW	17.5	26.5	26.5	31.5
Jockey pump				
Nominal motor power P_2 / kW	1.1	1.1	1.1	1.1
Nominal current 3~400 V, 50 Hz I_N / A	2.5	2.5	2.5	2.5

Fire fighting

Fire extinguishing systems

Technical data Wilo-SiFire EN

Pump curves

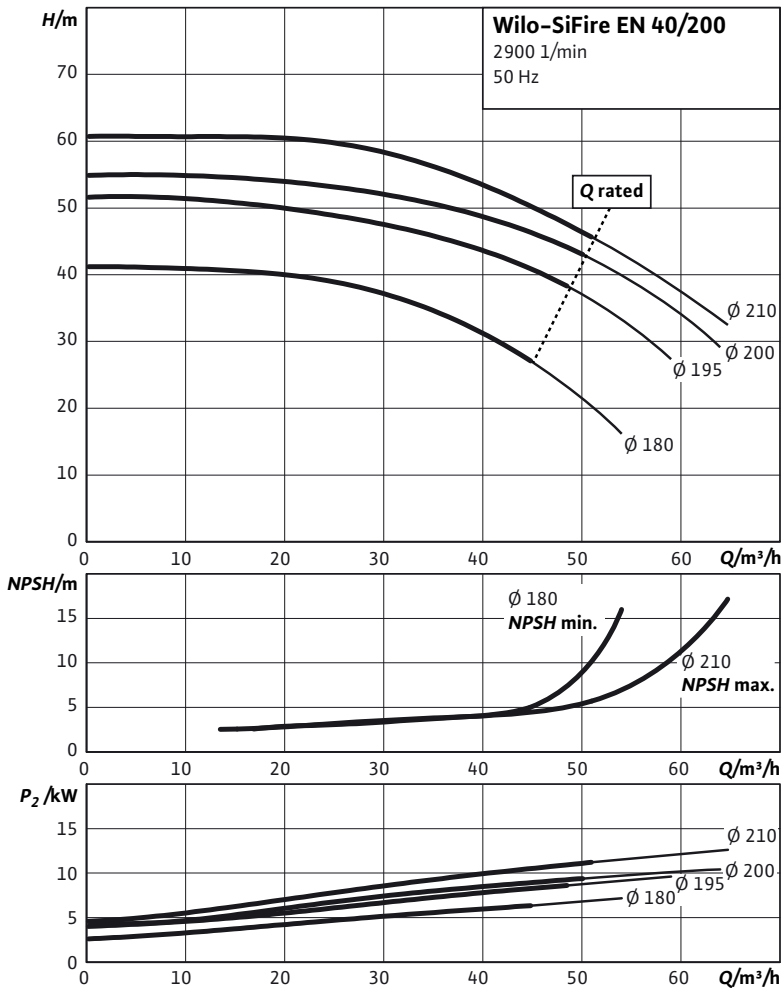

Motor data

	SiFire EN 40/200			
	180	195	200	210
Impeller mm	180	195	200	210
Electric pump				
Nominal motor power P_2 / kW	7.5	11	11	15
Nominal current 3~400 V, 50 Hz I_N / A	14.1	20.4	20.4	27.6
Diesel pump				
Nominal motor power P / kW	10.25	10.25	12.5	12.5
Jockey pump				
Nominal motor power P_2 / kW	0.55	0.75	0.75	1.1
Nominal current 3~400 V, 50 Hz I_N / A	1.8	1.83	1.83	2.5

Technical data Wilo-SiFire EN

Pump curves

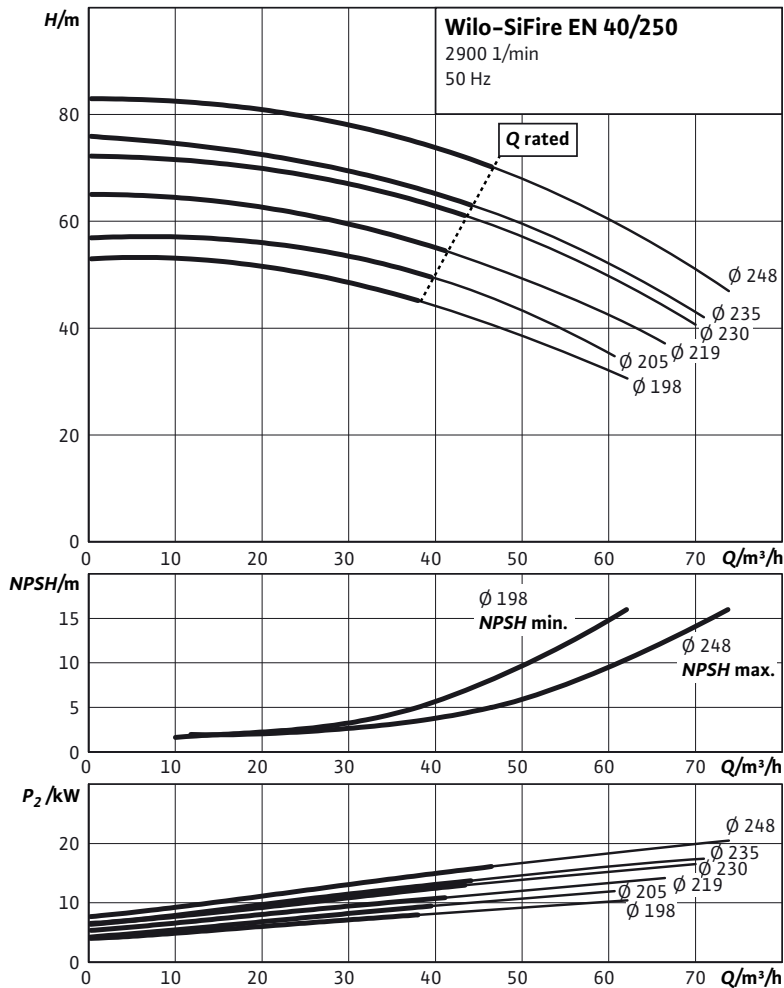

Motor data						
	SiFire EN 40/250					
Impeller mm	198	205	219	230	235	248
Electric pump						
Nominal motor power P_2 / kW	11	15	15	18.5	18.5	22
Nominal current 3~400 V, 50 Hz I_N / A	20.4	27.6	27.6	33.7	33.7	39.1
Diesel pump						
Nominal motor power P / kW	12.5	12.5	17.5	17.5	26.5	26.5
Jockey pump						
Nominal motor power P_2 / kW	0.75	1.1	1.1	1.1	1.1	1.1
Nominal current 3~400 V, 50 Hz I_N / A	1.83	2.5	2.5	2.5	2.5	2.5

Fire fighting

Fire extinguishing systems

Technical data Wilo-SiFire EN

Pump curves

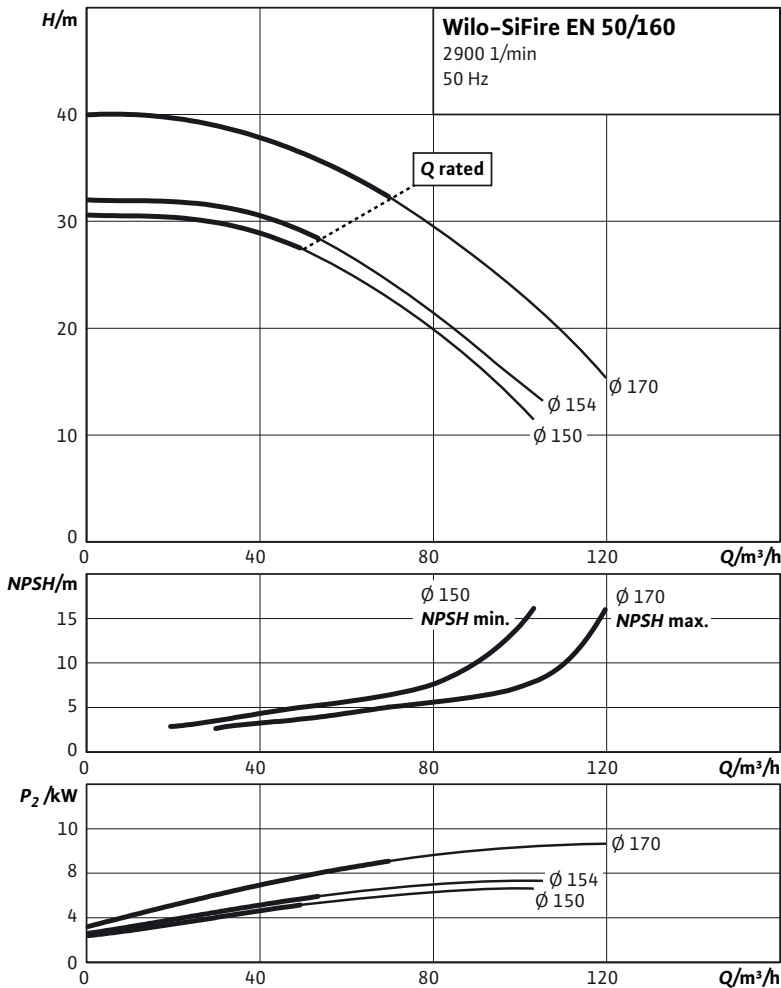

Motor data

	SiFire EN 50/160		
	150	154	170
Impeller mm	150	154	170
Electric pump			
Nominal motor power P_2 / kW	7.5	7.5	11
Nominal current 3~400 V, 50 Hz I_N / A	14.1	14.1	20.4
Diesel pump			
Nominal motor power P / kW	6.7	10.25	12.5
Jockey pump			
Nominal motor power P_2 / kW	0.55	0.55	0.55
Nominal current 3~400 V, 50 Hz I_N / A	1.8	1.8	1.8

Technical data Wilo-SiFire EN

Pump curves

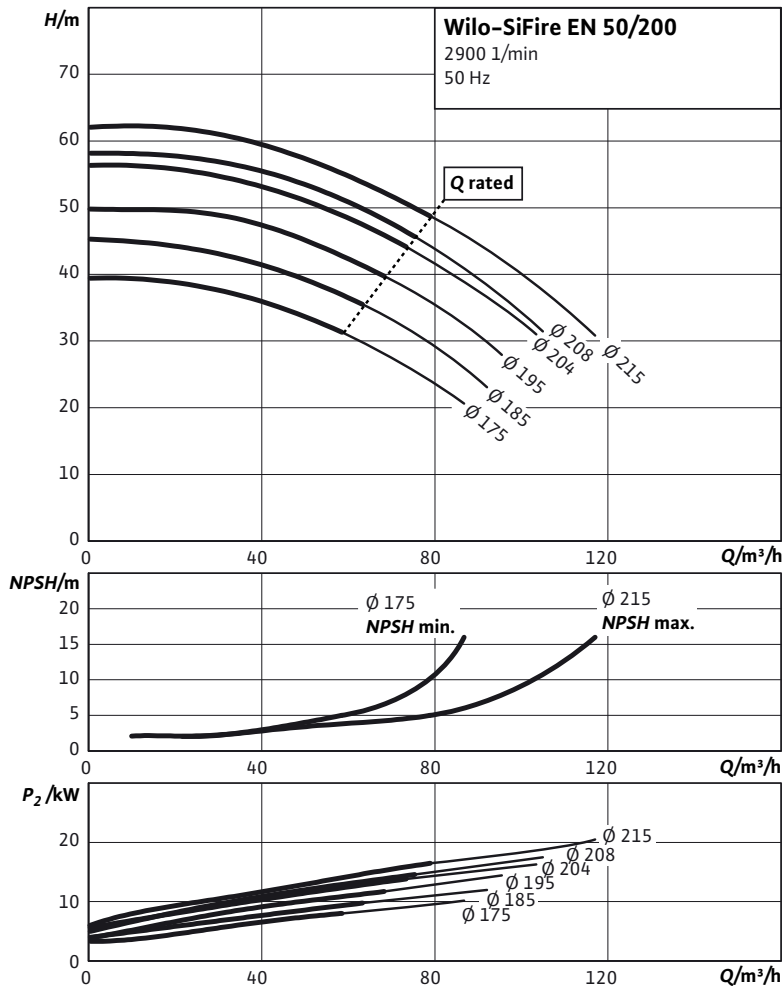

Motor data

	SiFire EN 50/200					
	175	185	195	204	208	215
Impeller mm	175	185	195	204	208	215
Electric pump						
Nominal motor power P_2 / kW	11	15	15	18.5	18.5	22
Nominal current 3~400 V, 50 Hz I_N / A	20.4	27.6	27.6	33.7	33.7	39.1
Diesel pump						
Nominal motor power P / kW	12.5	12.5	17.5	17.5	26.5	26.5
Jockey pump						
Nominal motor power P_2 / kW	0.55	0.75	1.1	1.1	1.1	1.1
Nominal current 3~400 V, 50 Hz I_N / A	1.8	1.83	2.5	2.5	2.5	2.5

Fire fighting

Fire extinguishing systems

Technical data Wilo-SiFire EN

Pump curves

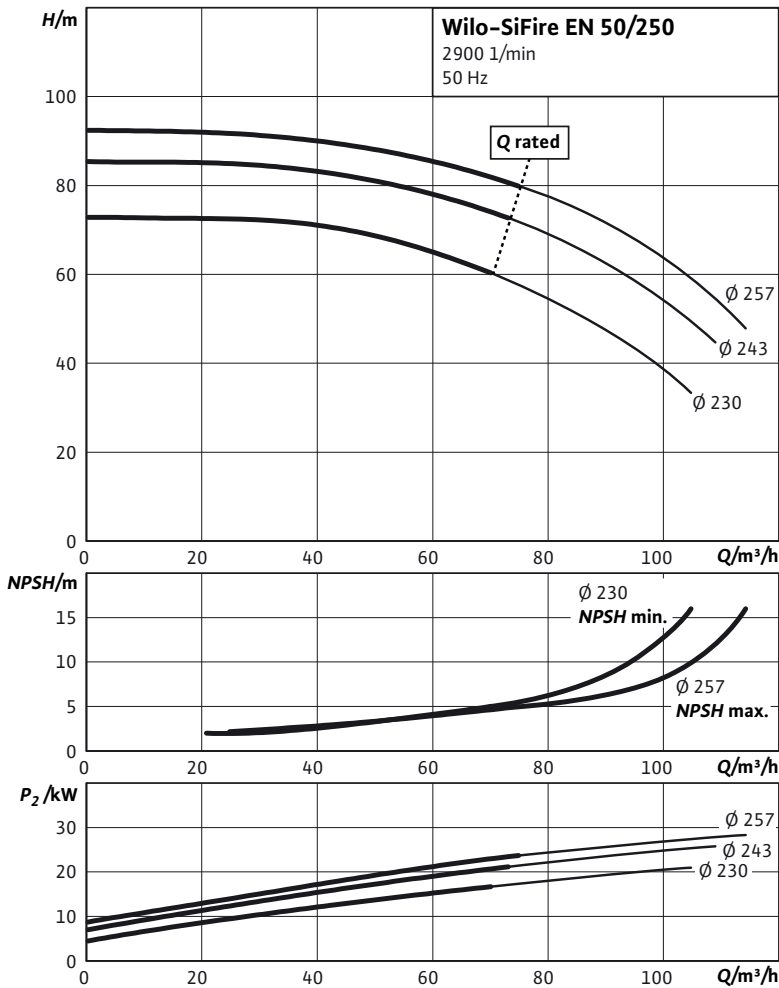

Motor data

	SiFire EN 50/250		
	230	243	257
Impeller mm	230	243	257
Electric pump			
Nominal motor power P_2 / kW	22	30	30
Nominal current 3~400 V, 50 Hz I_N / A	39.1	53.6	53.6
Diesel pump			
Nominal motor power P / kW	26.5	26.5	31.5
Jockey pump			
Nominal motor power P_2 / kW	1.1	1.1	1.1
Nominal current 3~400 V, 50 Hz I_N / A	2.5	2.5	2.5

Technical data Wilo-SiFire EN

Pump curves

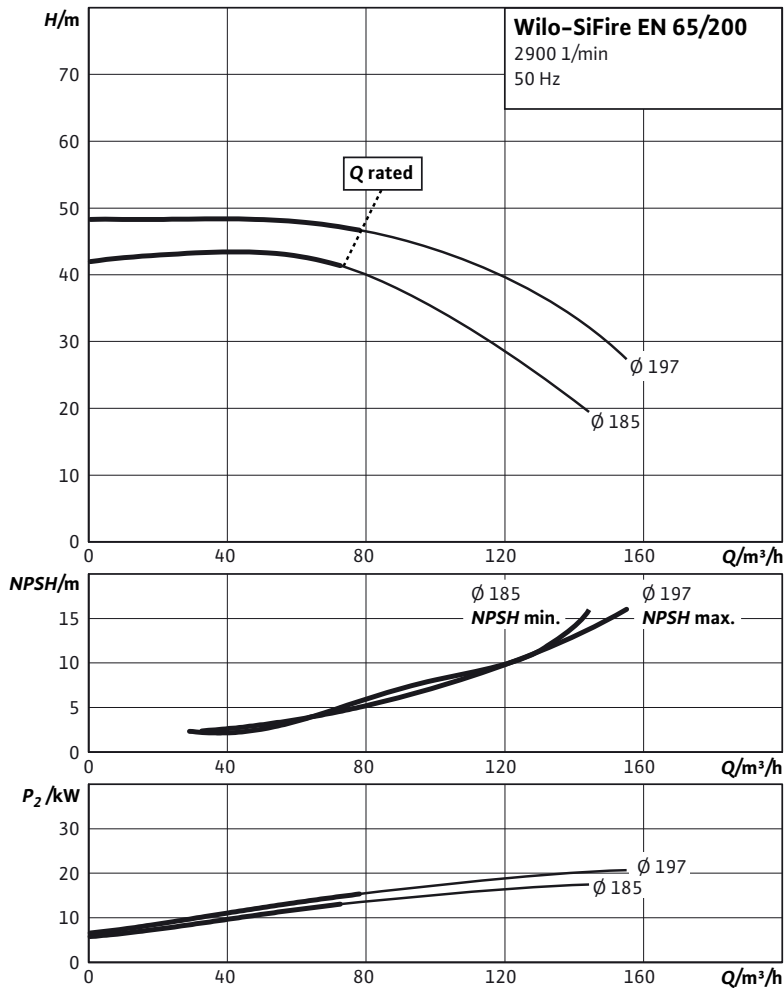

Motor data		
	SiFire EN 65/200	
Impeller mm	185	197
Electric pump		
Nominal motor power P_2 / kW	18.5	22
Nominal current 3~400 V, 50 Hz I_N / A	33.7	39.1
Diesel pump		
Nominal motor power P / kW	17.5	26.5
Jockey pump		
Nominal motor power P_2 / kW	0.55	0.75
Nominal current 3~400 V, 50 Hz I_N / A	1.8	1.83

Fire fighting

Fire extinguishing systems

Technical data Wilo-SiFire EN

Pump curves

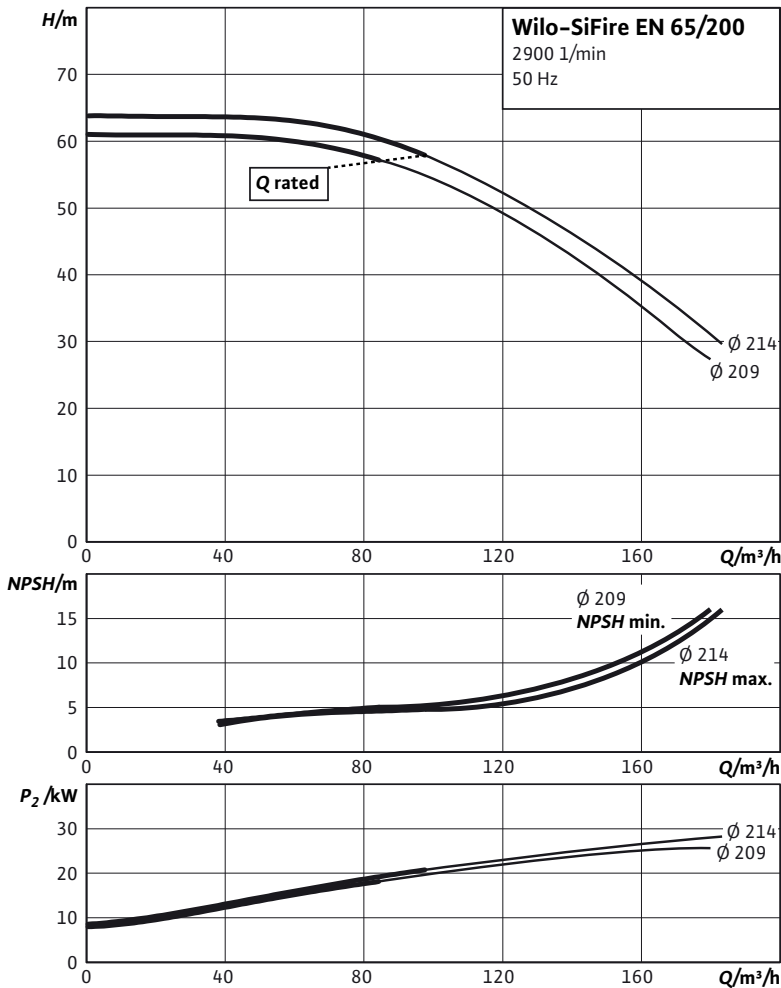

Motor data

		SiFire EN 65/200	
Impeller mm		209	214
Electric pump			
Nominal motor power P_2 / kW		30	30
Nominal current 3~400 V, 50 Hz I_N / A		53.6	53.6
Diesel pump			
Nominal motor power P / kW		26.5	31.5
Jockey pump			
Nominal motor power P_2 / kW		1.1	1.1
Nominal current 3~400 V, 50 Hz I_N / A		2.5	2.5

Technical data Wilo-SiFire EN

Pump curves

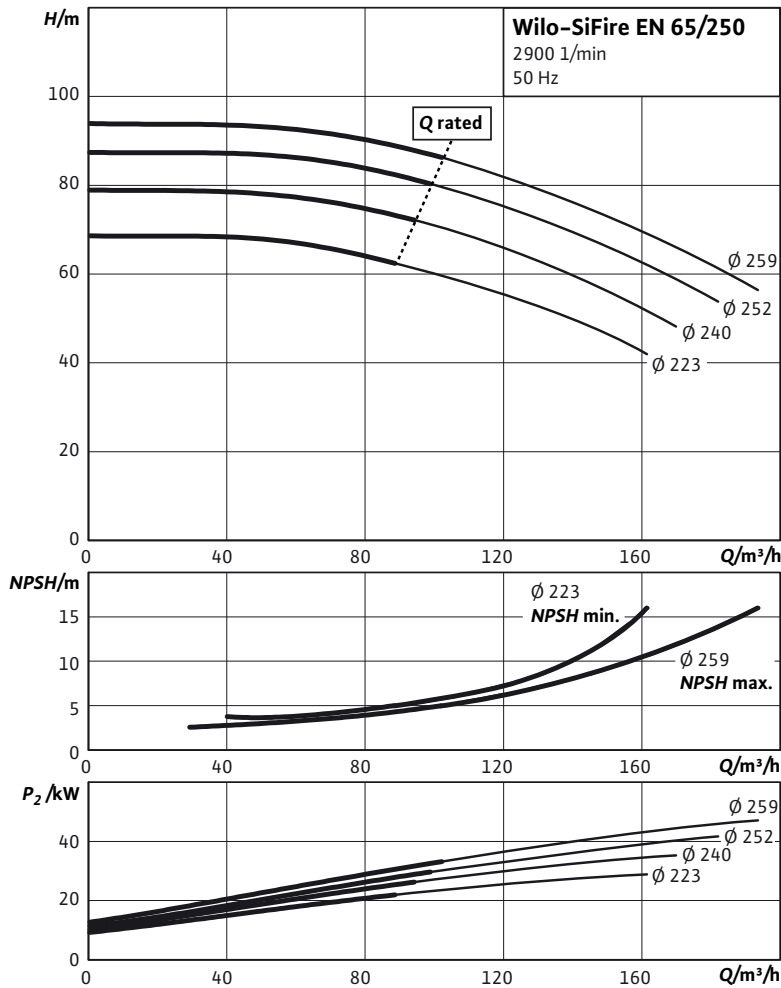

Motor data				
	SiFire EN 65/250			
Impeller mm	223	240	252	259
Electric pump				
Nominal motor power P_2 / kW	30	37	45	55
Nominal current 3~400 V, 50 Hz I_N / A	53.6	65.8	78	95
Diesel pump				
Nominal motor power P / kW	31.5	47.7	47.7	66
Jockey pump				
Nominal motor power P_2 / kW	1.1	1.1	1.1	1.1
Nominal current 3~400 V, 50 Hz I_N / A	2.5	2.5	2.5	2.5

Fire fighting

Fire extinguishing systems

Technical data Wilo-SiFire EN

Pump curves

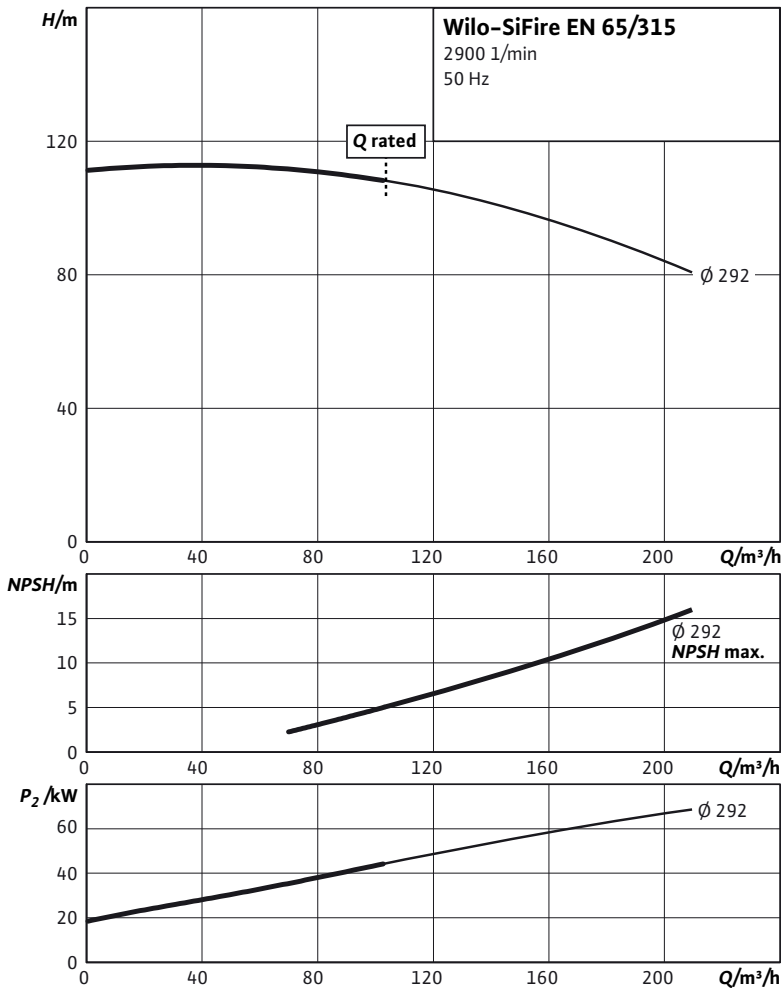

Motor data

Motor data		SiFire EN 65/315
Impeller mm		292
Electric pump		
Nominal motor power P_2 / kW		75
Nominal current 3~400 V, 50 Hz I_N / A		129
Diesel pump		
Nominal motor power P / kW		100
Jockey pump		
Nominal motor power P_2 / kW		1.5
Nominal current 3~400 V, 50 Hz I_N / A		3.3

Technical data Wilo-SiFire EN

Pump curves

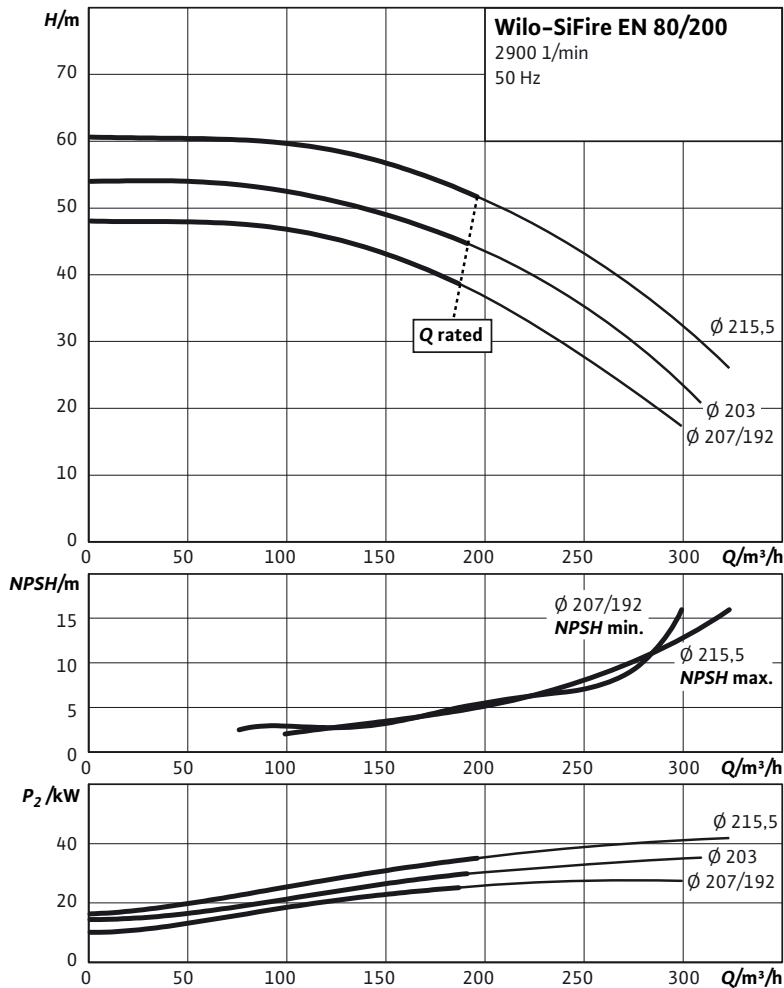

Motor data

	SiFire EN 80/200		
Impeller mm	199.5	203	215.5
Electric pump			
Nominal motor power P_2 / kW	30	37	45
Nominal current 3~400 V, 50 Hz I_N / A	53.6	65.8	78
Diesel pump			
Nominal motor power P / kW	31.5	47.7	47.7
Jockey pump			
Nominal motor power P_2 / kW	0.75	1.1	1.1
Nominal current 3~400 V, 50 Hz I_N / A	1.83	2.5	2.5

Fire fighting

Fire extinguishing systems

Technical data Wilo-SiFire EN

Pump curves

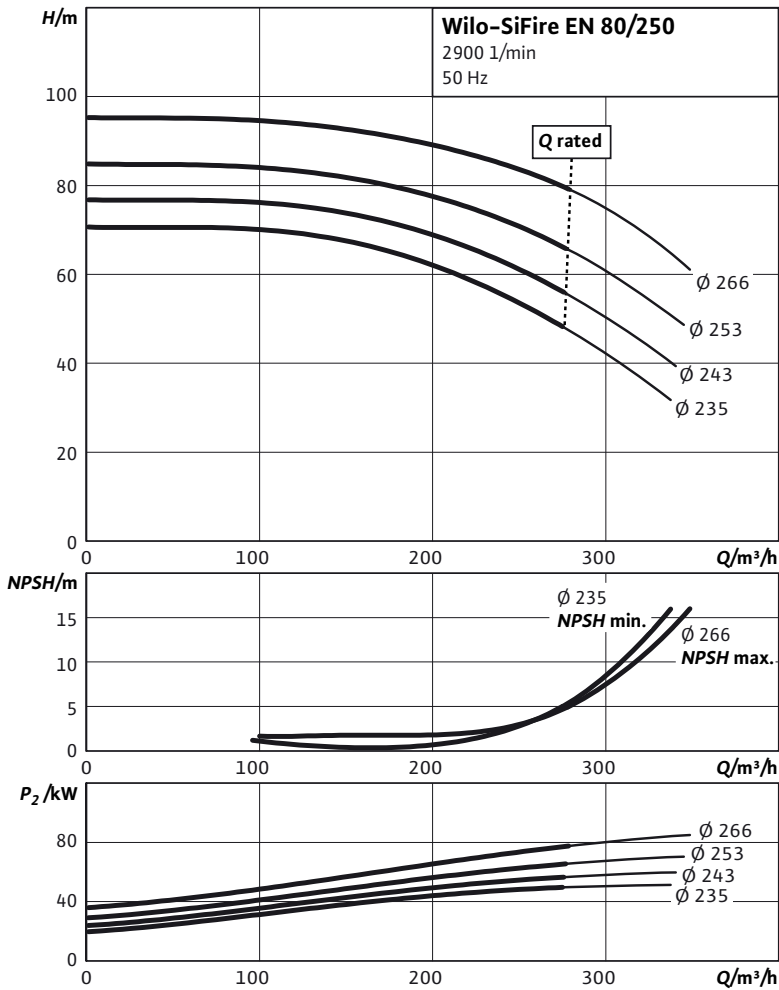

Motor data

	SiFire EN 80/250			
	235	243	253	266
Impeller mm	235	243	253	266
Electric pump				
Nominal motor power P_2 / kW	55	75	75	90
Nominal current 3~400 V, 50 Hz I_N / A	95	129	129	154
Diesel pump				
Nominal motor power P / kW	66	66	100	100
Jockey pump				
Nominal motor power P_2 / kW	1.1	1.1	1.1	1.1
Nominal current 3~400 V, 50 Hz I_N / A	2.5	2.5	2.5	2.5

Technical data Wilo-SiFire EN

Pump curves

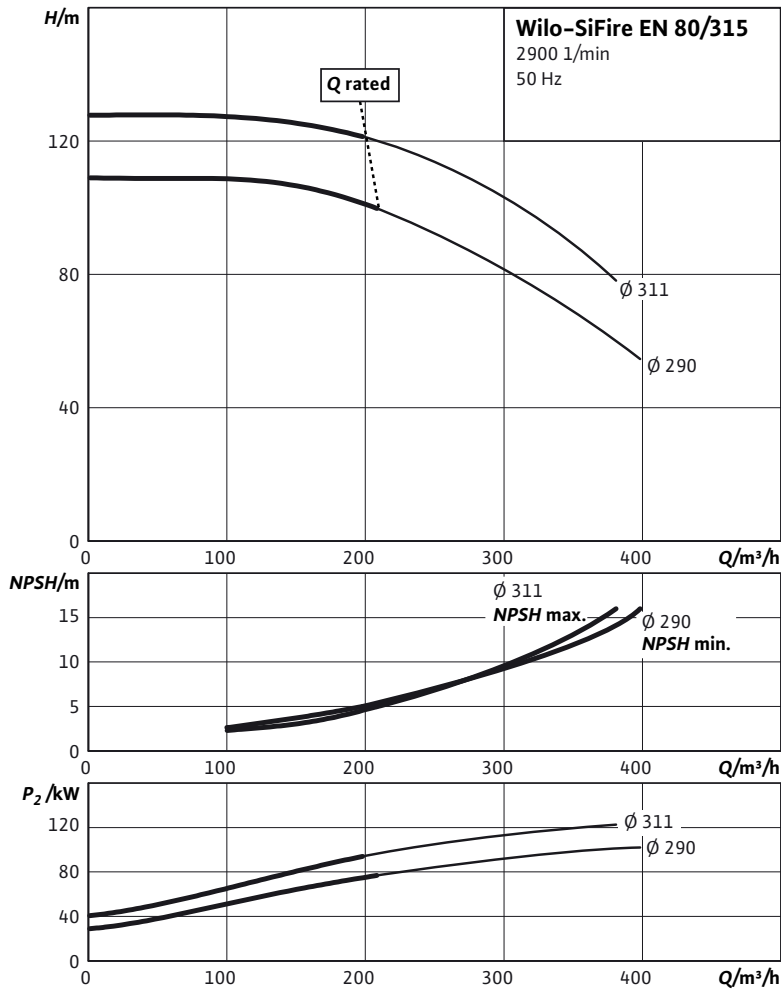

Motor data		
	SiFire EN 80/315	
Impeller mm	290	311
Electric pump		
Nominal motor power P_2 / kW	110	132
Nominal current 3~400 V, 50 Hz I_N / A	188	223
Diesel pump		
Nominal motor power P / kW	109	144.5
Jockey pump		
Nominal motor power P_2 / kW	1.5	1.5
Nominal current 3~400 V, 50 Hz I_N / A	3,3	3,3

Fire fighting

Fire extinguishing systems

Technical data Wilo-SiFire EN

Pump curves

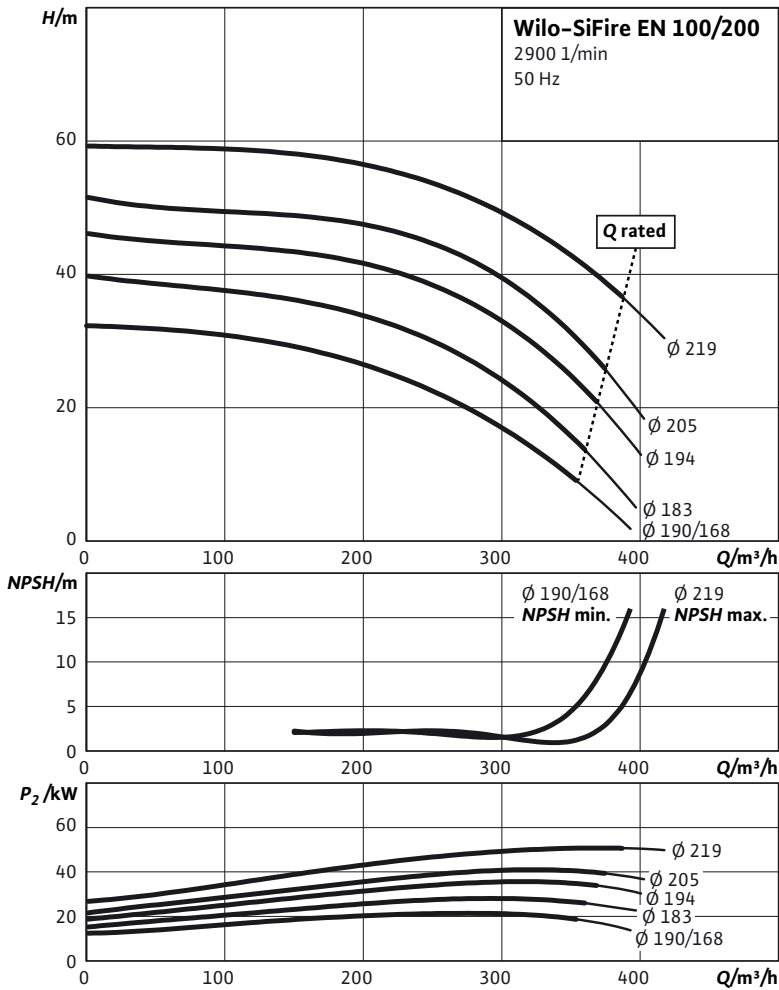

Motor data

	SiFire EN 100/200				
	179	183	194	205	219
Impeller mm	179	183	194	205	219
Electric pump					
Nominal motor power P_2 / kW	22	30	37	45	55
Nominal current 3~400 V, 50 Hz I_N / A	39.1	53.6	65.8	78	95
Diesel pump					
Nominal motor power P / kW	26.5	31.5	47.7	47.7	66
Jockey pump					
Nominal motor power P_2 / kW	0.55	0.55	0.75	0.75	1.1
Nominal current 3~400 V, 50 Hz I_N / A	1.8	1.8	1.83	1.83	2.5

Technical data Wilo-SiFire EN

Pump curves

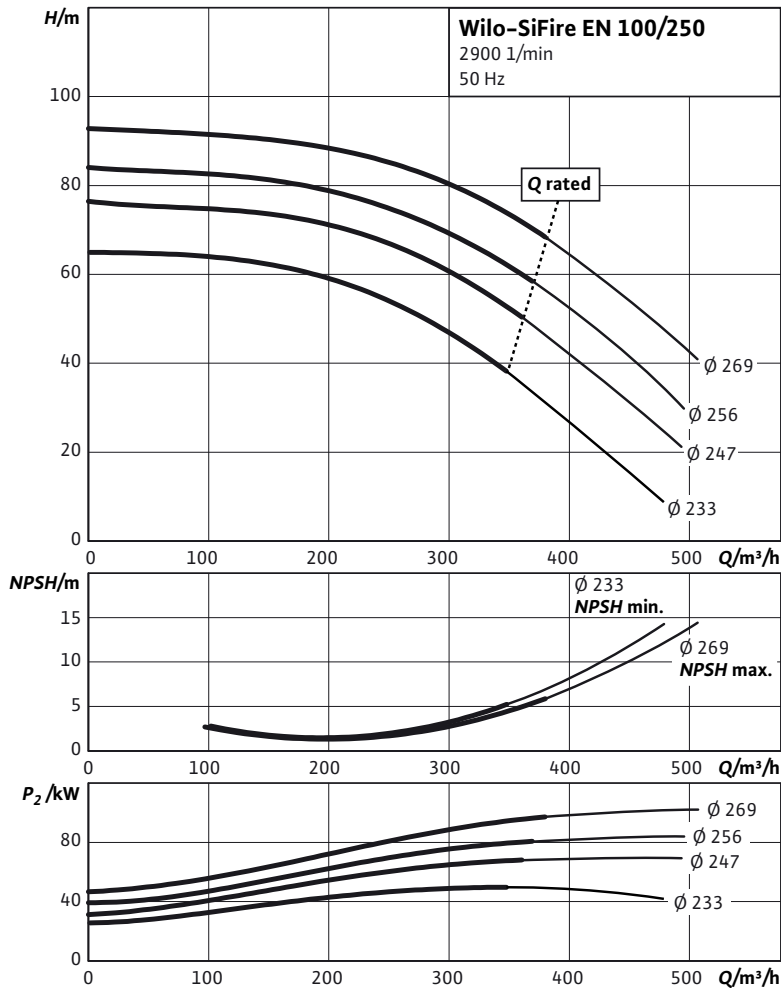

Motor data

	SiFire EN 100/250			
	233	247	256	269
Impeller mm	233	247	256	269
Electric pump				
Nominal motor power P_2 / kW	55	75	90	110
Nominal current 3~400 V, 50 Hz I_N / A	95	129	154	188
Diesel pump				
Nominal motor power P / kW	66	100	100	109
Jockey pump				
Nominal motor power P_2 / kW	1.1	1.1	1.1	1.1
Nominal current 3~400 V, 50 Hz I_N / A	2.5	2.5	2.5	2.5

Fire fighting

Fire extinguishing systems

Technical data Wilo-SiFire EN

Pump curves

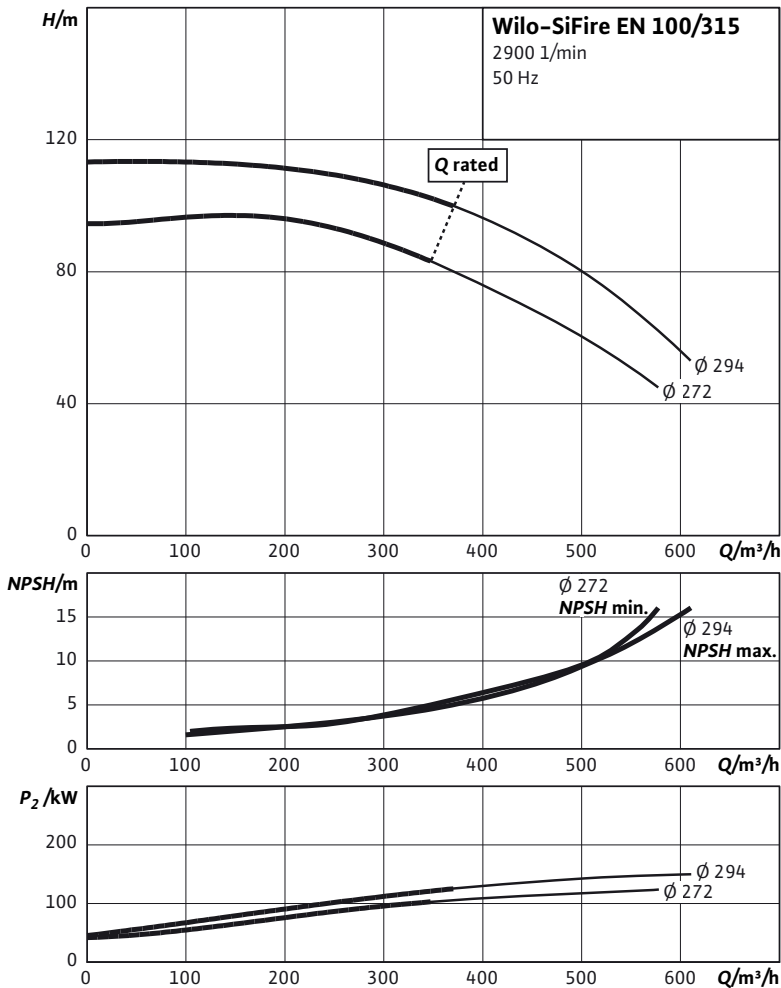

Motor data

SiFire EN 100/315		
Impeller mm	272	294
Electric pump		
Nominal motor power P_2 / kW	132	160
Nominal current 3~400 V, 50 Hz I_N / A	223	269
Diesel pump		
Nominal motor power P / kW	144.5	197
Jockey pump		
Nominal motor power P_2 / kW	1,5	1,5
Nominal current 3~400 V, 50 Hz I_N / A	3,3	3,3

Technical data Wilo-SiFire EN

Pump curves

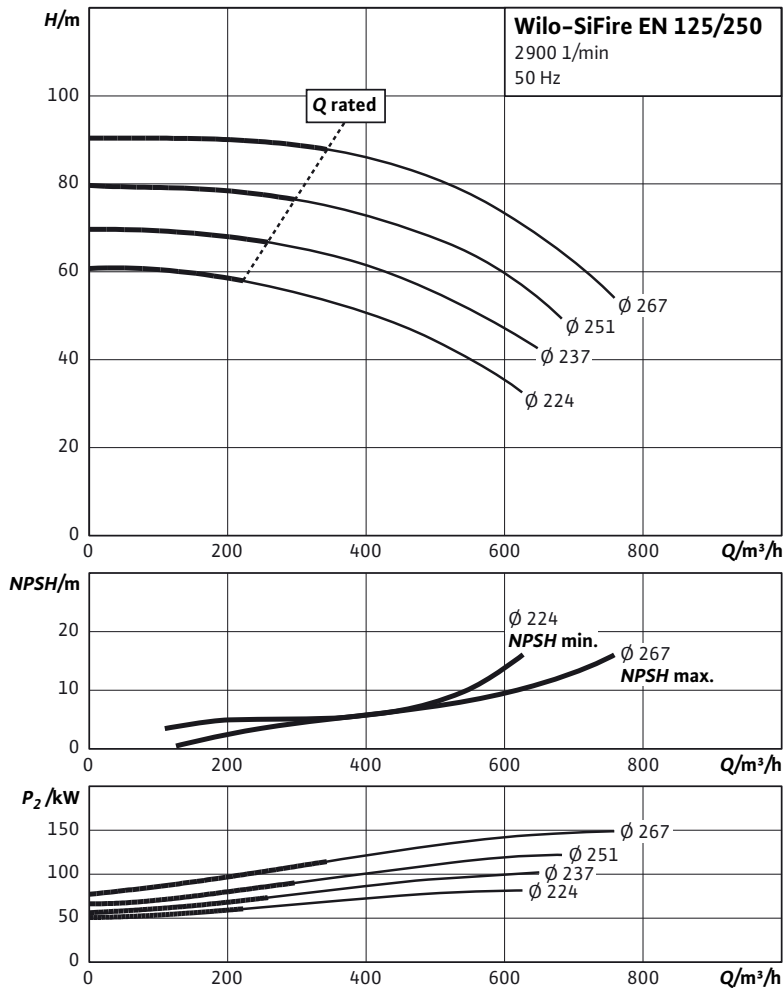

Motor data

	SiFire EN 125/250			
	224	237	251	267
Impeller mm	224	237	251	267
Electric pump				
Nominal motor power P_2 / kW	90	110	132	160
Nominal current 3~400 V, 50 Hz I_N / A	154	188	223	269
Diesel pump				
Nominal motor power P / kW	100	109	144.5	197
Jockey pump				
Nominal motor power P_2 / kW	1,1	1,1	1,1	1,1
Nominal current 3~400 V, 50 Hz I_N / A	2,5	2,5	2,5	2,5

Fire fighting

Fire extinguishing systems

Technical data Wilo-SiFire EN

Pump curves

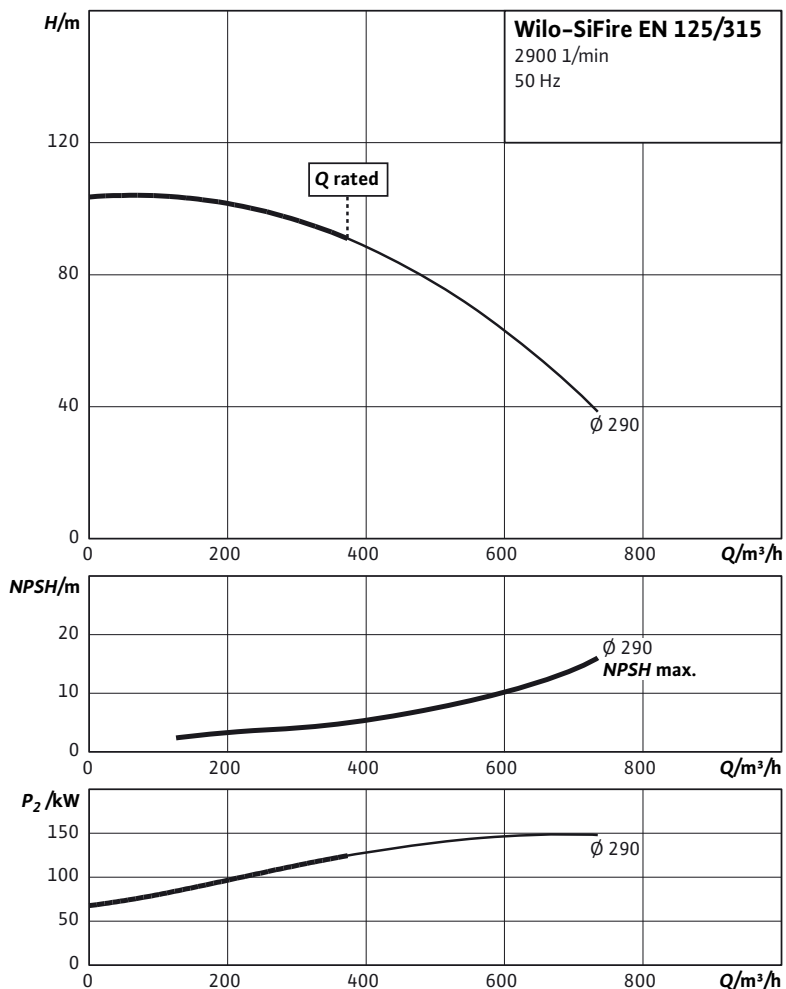

Motor data

SiFire EN 125/315	
Impeller mm	290
Electric pump	
Nominal motor power P_2 / kW	160
Nominal current 3~400 V, 50 Hz I_N / A	269
Diesel pump	
Nominal motor power P / kW	197
Jockey pump	
Nominal motor power P_2 / kW	1,5
Nominal current 3~400 V, 50 Hz I_N / A	3,3

Technical data Wilo-SiFire EN

Pump curves

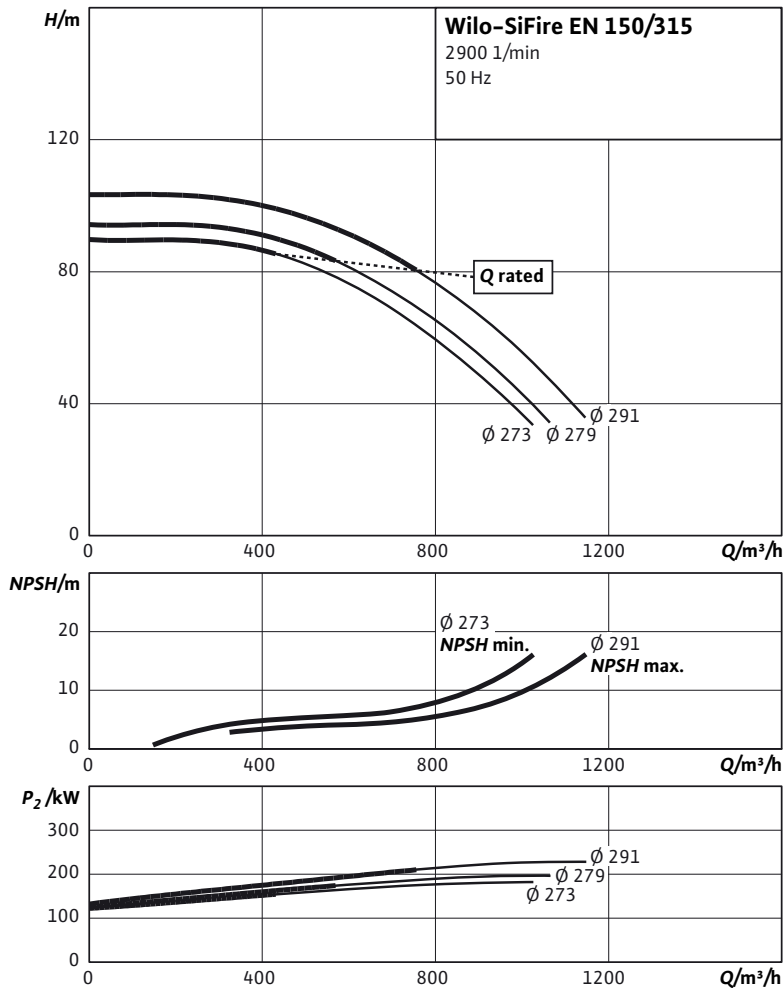

Motor data

	SiFire EN 150/315		
Impeller mm	273	279	291
Electric pump			
Nominal motor power P_2 / kW	200	250	250
Nominal current 3~400 V, 50 Hz I_N / A	336	415	415
Diesel pump			
Nominal motor power P / kW	221.5	221.5	245.5
Jockey pump			
Nominal motor power P_2 / kW	1,1	1,1	1,5
Nominal current 3~400 V, 50 Hz I_N / A	2,5	2,5	3,3

Fire fighting

Fire extinguishing systems

Technical data Wilo-SiFire EN

Dimension drawing

SiFire EN Electric

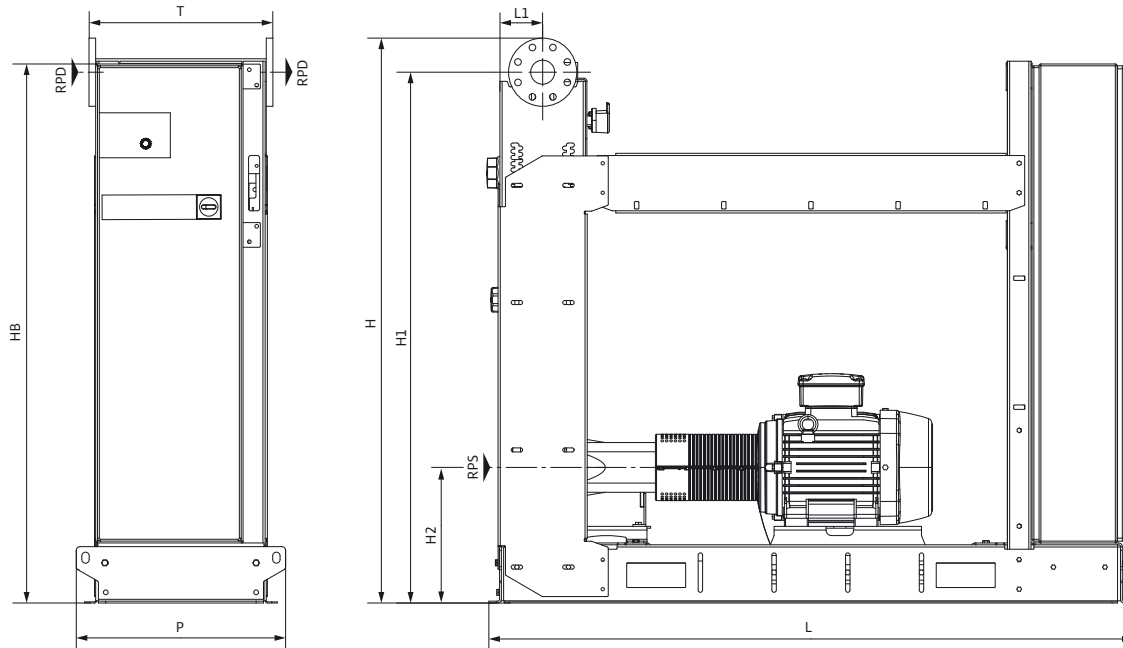

Sample systems are shown.
 Accessories are to be ordered separately.
 Installation surface: flat and horizontal
 Installation location: dry, well ventilated and frost-proof

Dimensions, weights

SiFire EN...	Nominal diameters of the pipe connections on suction side	Nominal diameters of pipe connections on the pressure side	Dimensions								Weight approx.
			RPS	RPD	H	H1	H2	HB	L	L1	
			mm								kg
32/200-177-4 E	DN 50	DN 65	1463	1370	368	1460	1547	116	568	499	380
32/200-193-5.5 E	DN 50	DN 65	1463	1370	368	1460	1547	116	568	499	402
32/200-205-7.5 E	DN 50	DN 65	1463	1370	368	1460	1547	116	568	499	405
32/200-210-7.5 E	DN 50	DN 65	1463	1370	368	1460	1547	116	568	499	405
32/250-210-15 E	DN 50	DN 65	1528	1435	388	1460	1747	116	568	499	487
32/250-225-18.5 E	DN 50	DN 65	1528	1435	388	1460	1747	116	568	499	499
32/250-235-22 E	DN 50	DN 65	1528	1435	388	1460	1747	116	568	499	539
32/250-257-30 E	DN 50	DN 65	1528	1435	388	1460	2098	116	744	675	671
40/200-180-7.5 E	DN 65	DN 65	1463	1370	368	1460	1547	116	568	499	407
40/200-195-11 E	DN 65	DN 65	1463	1370	368	1460	1747	116	568	499	473
40/200-200-11 E	DN 65	DN 65	1463	1370	368	1460	1747	116	568	499	473
40/200-210-15 E	DN 65	DN 65	1463	1370	368	1460	1747	116	568	499	481
40/250-198-11 E	DN 65	DN 65	1528	1435	388	1460	1747	116	568	499	482
40/250-205-15 E	DN 65	DN 65	1528	1435	388	1460	1747	116	568	499	490
40/250-219-15 E	DN 65	DN 65	1528	1435	388	1460	1747	116	568	499	490

Fire fighting

Fire extinguishing systems



Technical data Wilo-SiFire EN

Dimensions, weights

SiFire EN...	Nominal diameters of the pipe connections on suction side	Nominal diameters of pipe connections on the pressure side	Dimensions								Weight approx.
			<i>RPS</i>	<i>RPD</i>	<i>H</i>	<i>H1</i>	<i>H2</i>	<i>HB</i>	<i>L</i>	<i>L1</i>	
mm											
											kg
40/250-230-18.5 E	DN 65	DN 65	1528	1435	388	1460	1747	116	568	499	502
40/250-235-18.5 E	DN 65	DN 65	1528	1435	388	1460	1747	116	568	499	502
40/250-248-22 E	DN 65	DN 65	1528	1435	388	1460	1747	116	568	499	542
50/160-150-7.5 E	DN 65	DN 80	1520	1420	368	1460	1547	116	568	503	410
50/160-154-7.5 E	DN 65	DN 80	1520	1420	368	1460	1547	116	568	503	410
50/160-170-11 E	DN 65	DN 80	1520	1420	368	1460	1747	116	568	503	476
50/200-175-11 E	DN 65	DN 80	1540	1440	368	1460	1747	116	568	503	482
50/200-185-15 E	DN 65	DN 80	1540	1440	368	1460	1747	116	568	503	490
50/200-195-15 E	DN 65	DN 80	1540	1440	368	1460	1747	116	568	503	490
50/200-204-18.5 E	DN 65	DN 80	1540	1440	368	1460	1747	116	568	503	502
50/200-208-18.5 E	DN 65	DN 80	1540	1440	368	1460	1747	116	568	503	502
50/200-215-22 E	DN 65	DN 80	1540	1440	368	1460	1747	116	568	503	542
50/250-230-22 E	DN 65	DN 80	1590	1490	388	1460	1747	116	568	503	549
50/250-243-30 E	DN 65	DN 80	1590	1490	388	1460	2098	116	744	679	681
50/250-257-30 E	DN 65	DN 80	1590	1490	388	1460	2098	116	744	679	681
65/200-185-18.5 E	DN 80	DN 100	1690	1580	388	1460	1747	116	568	503	512
65/200-197-22 E	DN 80	DN 100	1690	1580	388	1460	1747	116	568	503	552
65/200-209-30 E	DN 80	DN 100	1690	1580	388	1460	2098	116	744	679	684
65/200-214-30 E	DN 80	DN 100	1690	1580	388	1460	2098	116	744	679	684
65/250-223-30 E	DN 80	DN 100	1750	1640	415	1460	2098	116	744	679	711
65/250-240-37 E	DN 80	DN 100	1750	1640	415	1460	2098	116	744	679	750
65/250-252-45 E	DN 80	DN 100	1750	1640	415	1460	2098	116	744	679	851
65/250-259-55 E	DN 80	DN 100	1750	1640	415	1460	2098	116	744	679	908
65/315-292-75 E	DN 80	DN 100	2015	1905	648	1814	2737	116	1026	961	1233
80/200-192R-30 E	DN 100	DN 125	1860	1735	395	1460	2098	125	744	683	710
80/200-203-37 E	DN 100	DN 125	1860	1735	395	1460	2098	125	744	683	749
80/200-215.5-45 E	DN 100	DN 125	1860	1735	395	1460	2098	125	744	683	850
80/250-235-55 E	DN 100	DN 125	1910	1785	415	1460	2098	125	744	683	919
80/250-243-75 E	DN 100	DN 125	2152	2027	654	1814	2737	125	1026	961	1242
80/250-253-75 E	DN 100	DN 125	2152	2027	654	1814	2737	125	1026	961	1242
80/250-266-90 E	DN 100	DN 125	2152	2027	654	1814	2737	125	1026	961	1281
80/315-290-110 E	DN 100	DN 125	2219	2094	689	1814	2737	125	1026	965	1493
80/315-311-132 E	DN 100	DN 125	2219	2094	689	1814	2737	125	1026	965	1529
100/200-168R-22 E	DN 125	DN 150	2113	1970	415	1460	2098	143	744	683	594
100/200-183-30 E	DN 125	DN 150	2113	1970	415	1460	2098	143	744	683	726
100/200-194-37 E	DN 125	DN 150	2113	1970	415	1460	2098	143	744	683	765
100/200-205-45 E	DN 125	DN 150	2113	1970	415	1460	2098	143	744	683	866
100/200-219-55 E	DN 125	DN 150	2113	1970	415	1460	2098	143	744	683	923
100/250-233-55 E	DN 125	DN 150	2143	2000	440	1460	2098	143	744	683	937
100/250-247-75 E	DN 125	DN 150	2328	2203	689	1814	2737	143	1026	965	1287
100/250-256-90 E	DN 125	DN 150	2328	2203	689	1814	2737	143	1026	965	1326

Fire fighting

Fire extinguishing systems

Technical data Wilo-SiFire EN

Dimensions, weights

SiFire EN...	Nominal diameters of the pipe connections on suction side	Nominal diameters of pipe connections on the pressure side	Dimensions								Weight approx.
			<i>RPS</i>	<i>RPD</i>	<i>H</i>	<i>H1</i>	<i>H2</i>	<i>HB</i>	<i>L</i>	<i>L1</i>	<i>P</i>
	mm								<i>m</i>	kg	
100/250-269-110 E	DN 125	DN 150	2328	2203	689	1814	2737	143	1026	965	1520
100/315-272-132 E	DN 125	DN 150	2380	2237	689	1814	2737	143	1026	965	1570
100/315-294-160 E	DN 125	DN 150	2380	2237	689	1814	2737	143	1026	965	1651
125/250-224-90 E	DN 150	DN 200	2433	2263	689	1814	2737	170	1026	969	1371
125/250-237-110 E	DN 150	DN 200	2433	2263	689	1814	2737	170	1026	969	1565
125/250-251-132 E	DN 150	DN 200	2433	2263	689	1814	2737	170	1026	969	1601
125/250-267-160 E	DN 150	DN 200	2433	2263	689	1814	2737	170	1026	969	1682
125/315-290-160 E	DN 150	DN 200	2434	2264	683	1814	2737	170	1026	969	1729
150/315-273-200 E	DN 200	DN 250	2778	2576	729	1814	2737	203	1026	973	2020
150/315-279-250 E	DN 200	DN 250	2778	2576	729	1814	2737	203	1026	973	2220
150/315-291-250 E	DN 200	DN 250	2778	2576	729	1814	2737	203	1026	973	2220

Fire fighting

Fire extinguishing systems



Technical data Wilo-SiFire EN

Dimension drawing

SiFire EN Diesel

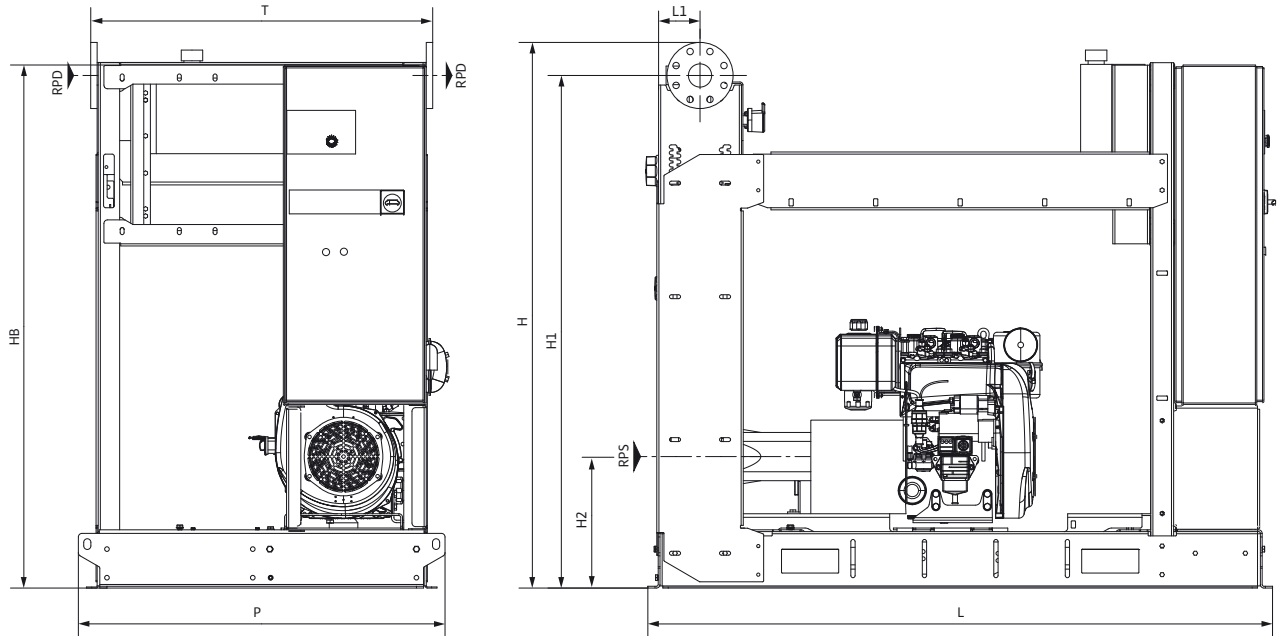

Sample systems are shown.
 Accessories are to be ordered separately.
 Installation surface: flat and horizontal
 Installation location: dry, well ventilated and frost-proof

Dimensions, weights

SiFire EN...	Nominal diameters of the pipe connections on suction side	Nominal diameters of pipe connections on the pressure side	Dimensions								Weight approx.
			RPS	RPD	H	H1	H2	HB	L	L1	
mm											m
											kg
32/200-177-4.25 D	DN 50	DN 65	1463	1370	368	1460	1547	116	1026	957	455
32/200-193-6.8 D	DN 50	DN 65	1463	1370	368	1460	1547	116	1026	957	470
32/200-205-6.8 D	DN 50	DN 65	1463	1370	368	1460	1547	116	1026	957	470
32/200-210-10.5 D	DN 50	DN 65	1463	1370	368	1460	1547	116	1026	957	500
32/250-210-17.7 D	DN 50	DN 65	1528	1435	388	1460	1747	116	1026	957	560
32/250-225-26.5 D	DN 50	DN 65	1528	1435	408	1460	1747	116	1026	957	615
32/250-235-26.5 D	DN 50	DN 65	1528	1435	408	1460	1747	116	1026	957	615
32/250-257-31.5 D	DN 50	DN 65	1528	1435	388	1460	2098	116	1026	957	450
40/200-180-10.5 D	DN 65	DN 65	1463	1370	368	1460	1547	116	1026	957	502
40/200-195-10.5 D	DN 65	DN 65	1463	1370	368	1460	1747	116	1026	957	507
40/200-200-12.9 D	DN 65	DN 65	1463	1370	368	1460	1747	116	1026	957	507
40/200-210-12.9 D	DN 65	DN 65	1463	1370	368	1460	1747	116	1026	957	507
40/250-198-12.9 D	DN 65	DN 65	1528	1435	388	1460	1747	116	1026	957	516
40/250-205-12.9 D	DN 65	DN 65	1528	1435	388	1460	1747	116	1026	957	516
40/250-219-17.7 D	DN 65	DN 65	1528	1435	388	1460	1747	116	1026	957	563

Fire fighting

Fire extinguishing systems

Technical data Wilo-SiFire EN

Dimensions, weights

SiFire EN...	Nominal diameters of the pipe connections on suction side	Nominal diameters of pipe connections on the pressure side	Dimensions								Weight approx.		
			<i>RPS</i>	<i>RPD</i>	<i>H</i>	<i>H1</i>	<i>H2</i>	<i>HB</i>	<i>L</i>	<i>L1</i>		<i>P</i>	<i>T</i>
			mm										<i>m</i>
			kg										
40/250-230-17.7 D	DN 65	DN 65	1528	1435	388	1460	1747	116	1026	957	563		
40/250-235-26.5 D	DN 65	DN 65	1528	1435	408	1460	1747	116	1026	957	618		
40/250-248-26.5 D	DN 65	DN 65	1528	1435	408	1460	1747	116	1026	957	618		
50/160-150-6.8 D	DN 65	DN 80	1520	1420	368	1460	1547	116	1026	961	475		
50/160-154-10.5 D	DN 65	DN 80	1520	1420	368	1460	1547	116	1026	961	505		
50/160-170-12.9 D	DN 65	DN 80	1520	1420	368	1460	1747	116	1026	961	510		
50/200-175-12.9 D	DN 65	DN 80	1540	1440	368	1460	1747	116	1026	961	516		
50/200-185-12.9 D	DN 65	DN 80	1540	1440	368	1460	1747	116	1026	961	516		
50/200-195-17.7 D	DN 65	DN 80	1540	1440	368	1460	1747	116	1026	961	563		
50/200-204-17.7 D	DN 65	DN 80	1540	1440	368	1460	1747	116	1026	961	563		
50/200-208-26.5 D	DN 65	DN 80	1540	1440	388	1460	1747	116	1026	961	618		
50/200-215-26.5 D	DN 65	DN 80	1540	1440	388	1460	1747	116	1026	961	618		
50/250-230-26.5 D	DN 65	DN 80	1590	1490	408	1460	1747	116	1026	961	625		
50/250-243-26.5 D	DN 65	DN 80	1590	1490	408	1460	2098	116	1026	961	625		
50/250-257-31.5 D	DN 65	DN 80	1590	1490	388	1460	2098	116	1026	961	755		
65/200-185-17.7 D	DN 80	DN 100	1690	1580	388	1460	1747	116	1026	961	573		
65/200-197-26.5 D	DN 80	DN 100	1690	1580	408	1460	1747	116	1026	961	628		
65/200-209-26.5 D	DN 80	DN 100	1690	1580	408	1460	2098	116	1026	961	628		
65/200-214-31.5 D	DN 80	DN 100	1690	1580	388	1460	2098	116	1026	961	758		
65/250-223-31.5 D	DN 80	DN 100	1750	1640	415	1460	2098	116	1026	961	785		
65/250-240-47.7 D	DN 80	DN 100	1750	1640	415	1460	2098	116	1026	961	821		
65/250-252-47.7 D	DN 80	DN 100	1750	1640	415	1460	2098	116	1026	961	821		
65/250-259-66 D	DN 80	DN 100	1750	1640	415	1460	2098	116	1026	961	855		
65/315-292-100 D	DN 80	DN 100	2015	1905	648	1460	2678	116	1582	1517	999		
80/200-192R-31.5 D	DN 100	DN 125	1860	1735	395	1460	2098	125	1026	965	784		
80/200-203-47.7 D	DN 100	DN 125	1860	1735	395	1460	2098	125	1026	965	820		
80/200-215.5-47.7 D	DN 100	DN 125	1860	1735	395	1460	2098	125	1026	965	820		
80/250-235-66 D	DN 100	DN 125	1910	1785	415	1460	2098	125	1026	1517	882		
80/250-243-66 D	DN 100	DN 125	1910	1785	415	1460	2098	125	1026	1517	882		
80/250-253-100 D	DN 100	DN 125	2152	2027	654	1460	2678	125	1582	1521	1008		
80/250-266-100 D	DN 100	DN 125	2152	2027	654	1460	2678	125	1582	1521	1008		
80/315-290-109 D	DN 100	DN 125	2219	2094	689	1460	2678	125	1582	1521	1046		
80/315-311-145 D	DN 100	DN 125	2219	2094	689	1460	2678	125	1582	1521	1051		
100/200-168R-26.5 D	DN 125	DN 150	2113	1970	435	1460	2098	143	1026	965	670		
100/200-183-31.5 D	DN 125	DN 150	2113	1970	415	1460	2098	143	1026	965	800		
100/200-194-47.7 D	DN 125	DN 150	2113	1970	415	1460	2098	143	1026	965	836		
100/200-205-47.7 D	DN 125	DN 150	2113	1970	415	1460	2098	143	1026	965	836		
100/200-219-66 D	DN 125	DN 150	2113	1970	415	1460	2098	143	1026	965	870		
100/250-233-66 D	DN 125	DN 150	2143	2000	440	1460	2098	143	1026	965	884		
100/250-247-100 D	DN 125	DN 150	2328	2203	689	1460	2678	143	1582	1521	1053		
100/250-256-100 D	DN 125	DN 150	2328	2203	689	1460	2678	143	1582	1521	1053		

Fire fighting

Fire extinguishing systems



Technical data Wilo-SiFire EN

Dimensions, weights

SiFire EN...	Nominal diameters of the pipe connections on suction side	Nominal diameters of pipe connections on the pressure side	Dimensions								Weight approx.		
			<i>RPS</i>	<i>RPD</i>	<i>H</i>	<i>H1</i>	<i>H2</i>	<i>HB</i>	<i>L</i>	<i>L1</i>		<i>P</i>	<i>T</i>
			mm									<i>m</i>	
100/250-269-109 D	DN 125	DN 150	2328	2203	689	1460	2678	143	1582	1521	1073		
100/315-272-145 D	DN 125	DN 150	2380	2237	689	1460	2678	143	1582	1521	1092		
100/315-294-197 D	DN 125	DN 150	2380	2237	689	1460	2678	143	1582	1521	1243		
125/250-224-100 D	DN 150	DN 200	2433	2263	689	1460	2678	170	1582	1525	1098		
125/250-237-109 D	DN 150	DN 200	2433	2263	689	1460	2678	170	1582	1525	1118		
125/250-251-145 D	DN 150	DN 200	2433	2263	689	1460	2678	170	1582	1525	1123		
125/250-267-197 D	DN 150	DN 200	2433	2263	689	1460	2678	170	1582	1525	1274		
125/315-290-197 D	DN 150	DN 200	2434	2264	683	1460	2678	170	1582	1525	1321		
150/315-273-222 D	DN 200	DN 250	2778	2576	729	1460	2678	203	1582	1529	1466		
150/315-279-222 D	DN 200	DN 250	2778	2576	729	1460	2678	203	1582	1529	1466		
150/315-291-246 D	DN 200	DN 250	2778	2576	729	1460	2678	203	1582	1529	1466		

Fire fighting

Fire extinguishing systems

Technical data Wilo-SiFire EN

Dimension drawing

SiFire EN Electric, Jockey

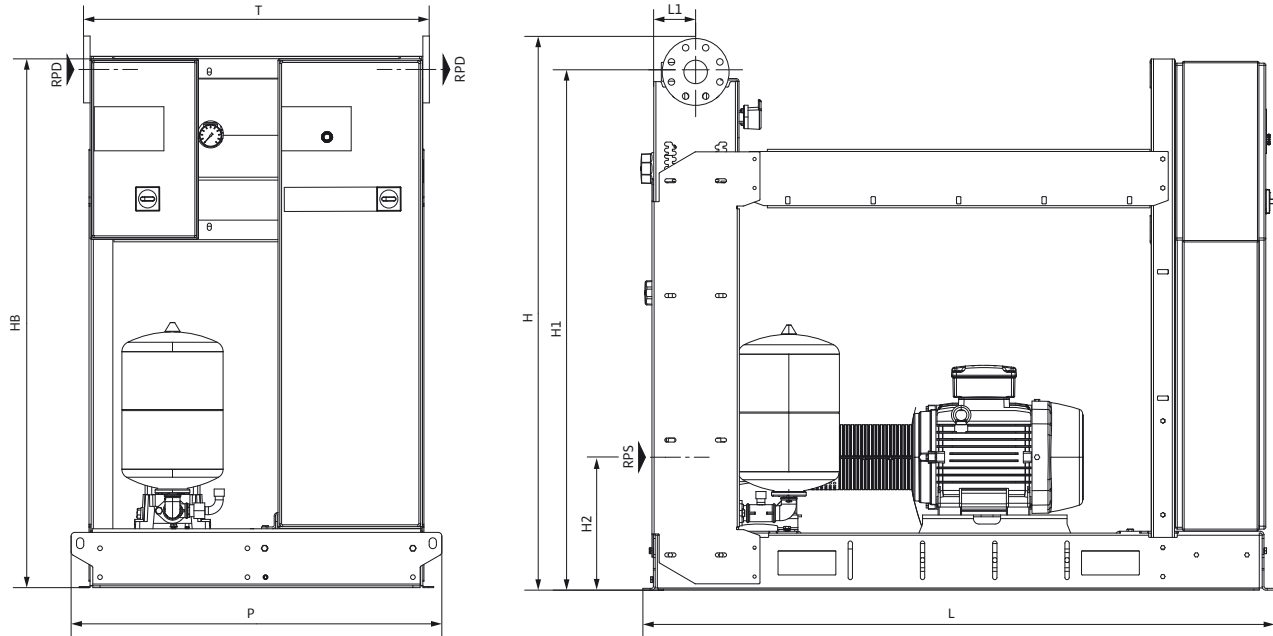

Sample systems are shown.

Accessories are to be ordered separately.

Installation surface: flat and horizontal

Installation location: dry, well ventilated and frost-proof

Dimensions, weights

SiFire EN...	Nominal diameters of the pipe connections on suction side	Nominal diameters of pipe connections on the pressure side	Dimensions								Weight approx.		
			RPS	RPD	H	H1	H2	HB	L	L1		P	T
			mm										m
32/200-177-4/0.55 EJ	DN 50	DN 65	1463	1370	368	1460	1547	116	1026	957	434		
32/200-193-5.5/0.55 EJ	DN 50	DN 65	1463	1370	368	1460	1547	116	1026	957	456		
32/200-205-7.5/0.75 EJ	DN 50	DN 65	1463	1370	368	1460	1547	116	1026	957	482		
32/200-210-7.5/0.75 EJ	DN 50	DN 65	1463	1370	368	1460	1547	116	1026	957	482		
32/250-210-15/1.1 EJ	DN 50	DN 65	1528	1435	388	1460	1747	116	1026	957	545		
32/250-225-18.5/1.1 EJ	DN 50	DN 65	1528	1435	388	1460	1747	116	1026	957	557		
32/250-235-22/1.1 EJ	DN 50	DN 65	1528	1435	388	1460	1747	116	1026	957	597		
32/250-257-30/1.1 EJ	DN 50	DN 65	1528	1435	388	1460	2098	116	1026	957	724		
40/200-180-7.5/0.55 EJ	DN 65	DN 65	1463	1370	368	1460	1547	116	1026	957	481		
40/200-195-11/0.75 EJ	DN 65	DN 65	1463	1370	368	1460	1747	116	1026	957	530		
40/200-200-11/0.75 EJ	DN 65	DN 65	1463	1370	368	1460	1747	116	1026	957	530		
40/200-210-15/1.1 EJ	DN 65	DN 65	1463	1370	368	1460	1747	116	1026	957	539		
40/250-198-11/0.75 EJ	DN 65	DN 65	1528	1435	388	1460	1747	116	1026	957	539		
40/250-205-15/1.1 EJ	DN 65	DN 65	1528	1435	388	1460	1747	116	1026	957	548		
40/250-219-15/1.1 EJ	DN 65	DN 65	1528	1435	388	1460	1747	116	1026	957	548		

Fire fighting

Fire extinguishing systems



Technical data Wilo-SiFire EN

Dimensions, weights

SiFire EN...	Nominal diameters of the pipe connections on suction side	Nominal diameters of pipe connections on the pressure side	Dimensions								Weight approx.
			<i>RPS</i>	<i>RPD</i>	<i>H</i>	<i>H1</i>	<i>H2</i>	<i>HB</i>	<i>L</i>	<i>L1</i>	
	mm								<i>m</i>		
40/250-230-18.5/1.1 EJ	DN 65	DN 65	1528	1435	388	1460	1747	116	1026	957	560
40/250-235-18.5/1.1 EJ	DN 65	DN 65	1528	1435	388	1460	1747	116	1026	957	560
40/250-248-22/1.1 EJ	DN 65	DN 65	1528	1435	388	1460	1747	116	1026	957	600
50/160-150-7.5/0.55 EJ	DN 65	DN 80	1520	1420	368	1460	1547	116	1026	961	484
50/160-154-7.5/0.55 EJ	DN 65	DN 80	1520	1420	368	1460	1547	116	1026	961	484
50/160-170-11/0.55 EJ	DN 65	DN 80	1520	1420	368	1460	1747	116	1026	961	530
50/200-175-11/0.55 EJ	DN 65	DN 80	1540	1440	368	1460	1747	116	1026	961	536
50/200-185-15/0.75 EJ	DN 65	DN 80	1540	1440	368	1460	1747	116	1026	961	547
50/200-195-15/1.1 EJ	DN 65	DN 80	1540	1440	368	1460	1747	116	1026	961	548
50/200-204-18.5/1.1 EJ	DN 65	DN 80	1540	1440	368	1460	1747	116	1026	961	560
50/200-208-18.5/1.1 EJ	DN 65	DN 80	1540	1440	368	1460	1747	116	1026	961	560
50/200-215-22/1.1 EJ	DN 65	DN 80	1540	1440	368	1460	1747	116	1026	961	600
50/250-230-22/1.1 EJ	DN 65	DN 80	1590	1490	388	1460	1747	116	1026	961	607
50/250-243-30/1.1 EJ	DN 65	DN 80	1590	1490	388	1460	2098	116	1026	961	734
50/250-257-30/1.1 EJ	DN 65	DN 80	1590	1490	388	1460	2098	116	1026	961	734
65/200-185-18.5/0.55 EJ	DN 80	DN 100	1690	1580	388	1460	1747	116	1026	961	566
65/200-197-22/0.75 EJ	DN 80	DN 100	1690	1580	388	1460	1747	116	1026	961	609
65/200-209-30/1.1 EJ	DN 80	DN 100	1690	1580	388	1460	2098	116	1026	961	737
65/200-214-30/1.1 EJ	DN 80	DN 100	1690	1580	388	1460	2098	116	1026	961	737
65/250-223-30/1.1 EJ	DN 80	DN 100	1750	1640	415	1460	2098	116	1026	961	764
65/250-240-37/1.1 EJ	DN 80	DN 100	1750	1640	415	1460	2098	116	1026	961	803
65/250-252-45/1.1 EJ	DN 80	DN 100	1750	1640	415	1460	2098	116	1026	961	904
65/250-259-55/1.1 EJ	DN 80	DN 100	1750	1640	415	1460	2098	116	1026	961	961
65/315-292-75/1,5 EJ	DN 80	DN 100	2015	1905	648	1814	2737	116	1582	1517	1360
80/200-192R-30/0.75 EJ	DN 100	DN 125	1860	1735	395	1460	2098	125	1026	965	762
80/200-203-37/1.1 EJ	DN 100	DN 125	1860	1735	395	1460	2098	125	1026	965	802
80/200-215.5-45/1.1 EJ	DN 100	DN 125	1860	1735	395	1460	2098	125	1026	965	903
80/250-235-55/1.1 EJ	DN 100	DN 125	1910	1785	415	1460	2098	125	1026	965	972
80/250-243-75/1,1 EJ	DN 100	DN 125	2152	2027	654	1814	2737	125	1582	1521	1369
80/250-253-75/1,1 EJ	DN 100	DN 125	2152	2027	654	1814	2737	125	1582	1521	1369
80/250-266-90/1,1 EJ	DN 100	DN 125	2152	2027	654	1814	2737	125	1582	1521	1408
80/315-290-110/1,5 EJ	DN 100	DN 125	2219	2094	689	1814	2737	125	1582	1521	1622
80/315-311-132/1,5 EJ	DN 100	DN 125	2219	2094	689	1814	2737	125	1582	1521	1658
100/200-168R-22/0.55 EJ	DN 125	DN 150	2113	1970	415	1460	2098	143	1026	965	713
100/200-183-30/0.55 EJ	DN 125	DN 150	2113	1970	415	1460	2098	143	1026	965	775
100/200-194-37/0.75 EJ	DN 125	DN 150	2113	1970	415	1460	2098	143	1026	965	817
100/200-205-45/0.75 EJ	DN 125	DN 150	2113	1970	415	1460	2098	143	1026	965	918
100/200-219-55/1.1 EJ	DN 125	DN 150	2113	1970	415	1460	2098	143	1026	965	976
100/250-233-55/1.1 EJ	DN 125	DN 150	2143	2000	440	1460	2098	143	1026	965	990
100/250-247-75/1,1 EJ	DN 125	DN 150	2328	2203	689	1814	2737	143	1582	1521	1418
100/250-256-90/1,1 EJ	DN 125	DN 150	2328	2203	689	1814	2737	143	1582	1521	1457

Fire fighting

Fire extinguishing systems

Technical data Wilo-SiFire EN

Dimensions, weights

SiFire EN...	Nominal diameters of the pipe connections on suction side	Nominal diameters of pipe connections on the pressure side	Dimensions								Weight approx.			
			<i>RPS</i>	<i>RPD</i>	<i>H</i>	<i>H1</i>	<i>H2</i>	<i>HB</i>	<i>L</i>	<i>L1</i>		<i>P</i>	<i>T</i>	<i>m</i>
			mm										kg	
100/250-269-110/1,1 EJ	DN 125	DN 150	2328	2203	689	1814	2737	143	1582	1521	1651			
100/315-272-132/1,5 EJ	DN 125	DN 150	2380	2237	689	1814	2737	143	1582	1521	1703			
100/315-294-160/1,5 EJ	DN 125	DN 150	2380	2237	689	1814	2737	143	1582	1521	1784			
125/250-224-90/1,1 EJ	DN 150	DN 200	2433	2263	689	1814	2737	170	1582	1525	1508			
125/250-237-110/1,1 EJ	DN 150	DN 200	2433	2263	689	1814	2737	170	1582	1525	1702			
125/250-251-132/1,1 EJ	DN 150	DN 200	2433	2263	689	1814	2737	170	1582	1525	1738			
125/250-267-160/1,1 EJ	DN 150	DN 200	2433	2263	689	1814	2737	170	1582	1525	1819			
125/315-290-160/1,5 EJ	DN 150	DN 200	2434	2264	683	1814	2737	170	1582	1525	1868			
150/315-273-200/1,1 EJ	DN 200	DN 250	2778	2576	729	1814	2737	203	1582	1529	2167			
150/315-279-250/1,1 EJ	DN 200	DN 250	2778	2576	729	1814	2737	203	1582	1529	2367			
150/315-291-250/1,5 EJ	DN 200	DN 250	2778	2576	729	1814	2737	203	1582	1529	2369			

Fire fighting

Fire extinguishing systems



Technical data Wilo-SiFire EN

Dimension drawing

SiFire EN Diesel, Jockey

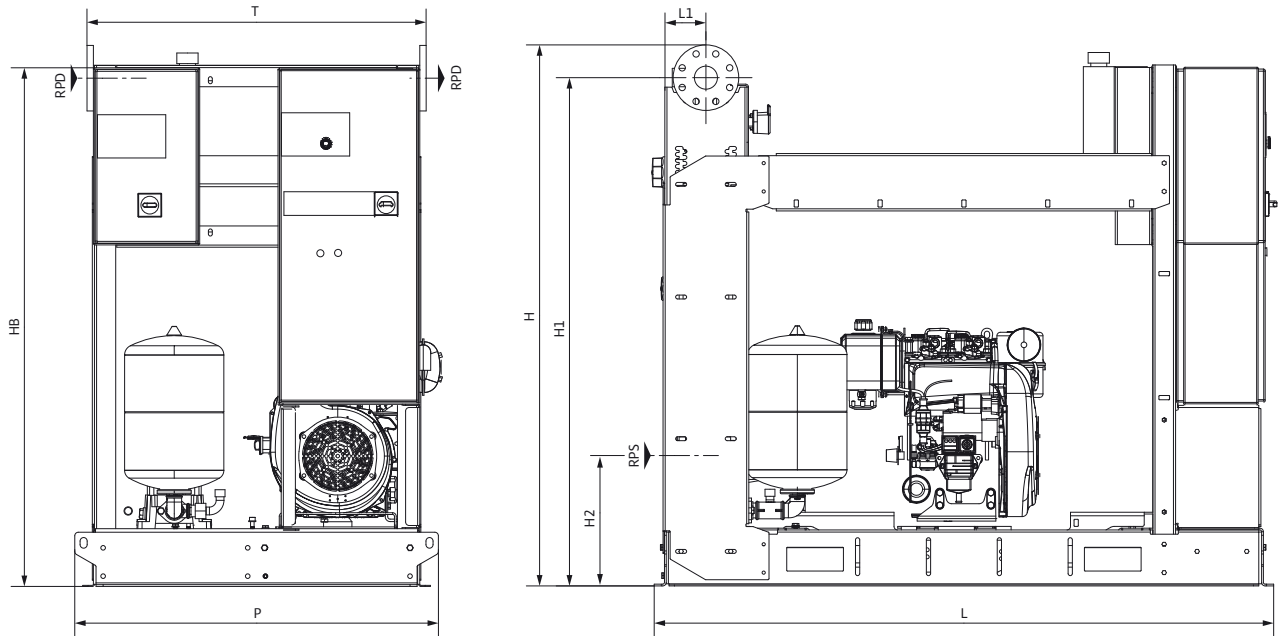

Sample systems are shown.
 Accessories are to be ordered separately.
 Installation surface: flat and horizontal
 Installation location: dry, well ventilated and frost-proof

Dimensions, weights

SiFire EN...	Nominal diameters of the pipe connections on suction side	Nominal diameters of pipe connections on the pressure side	Dimensions								Weight approx.
			RPS	RPD	H	H1	H2	HB	L	L1	
mm											m
32/200-177-4.25/0.55 DJ	DN 50	DN 65	1463	1370	368	1460	1547	116	1026	957	499
32/200-193-6.8/0.55 DJ	DN 50	DN 65	1463	1370	368	1460	1547	116	1026	957	514
32/200-205-6.8/0.75 DJ	DN 50	DN 65	1463	1370	368	1460	1547	116	1026	957	522
32/200-210-10.5/0.75 DJ	DN 50	DN 65	1463	1370	368	1460	1547	116	1026	957	552
32/250-210-17.7/1.1 DJ	DN 50	DN 65	1528	1435	388	1460	1747	116	1026	957	628
32/250-225-26.5/1.1 DJ	DN 50	DN 65	1528	1435	408	1460	1747	116	1026	957	683
32/250-235-26.5/1.1 DJ	DN 50	DN 65	1528	1435	408	1460	1747	116	1026	957	683
32/250-257-31.5/1.1 DJ	DN 50	DN 65	1528	1435	388	1460	2098	116	1026	957	793
40/200-180-10.5/0.55 DJ	DN 65	DN 65	1463	1370	368	1460	1547	116	1026	957	551
40/200-195-10.5/0.75 DJ	DN 65	DN 65	1463	1370	368	1460	1747	116	1026	957	559
40/200-200-12.9/0.75 DJ	DN 65	DN 65	1463	1370	368	1460	1747	116	1026	957	584
40/200-210-12.9/1.1 DJ	DN 65	DN 65	1463	1370	368	1460	1747	116	1026	957	585
40/250-198-12.9/0.75 DJ	DN 65	DN 65	1528	1435	388	1460	1747	116	1026	957	593
40/250-205-12.9/1.1 DJ	DN 65	DN 65	1528	1435	388	1460	1747	116	1026	957	594
40/250-219-17.7/1.1 DJ	DN 65	DN 65	1528	1435	388	1460	1747	116	1026	957	631

Fire fighting

Fire extinguishing systems

Technical data Wilo-SiFire EN

Dimensions, weights

SiFire EN...	Nominal diameters of the pipe connections on suction side	Nominal diameters of pipe connections on the pressure side	Dimensions								Weight approx.		
			<i>RPS</i>	<i>RPD</i>	<i>H</i>	<i>H1</i>	<i>H2</i>	<i>HB</i>	<i>L</i>	<i>L1</i>		<i>P</i>	<i>T</i>
			mm									<i>m</i>	
												kg	
40/250-230-17.7/1.1 DJ	DN 65	DN 65	1528	1435	388	1460	1747	116	1026	957	631		
40/250-235-26.5/1.1 DJ	DN 65	DN 65	1528	1435	408	1460	1747	116	1026	957	686		
40/250-248-26.5/1.1 DJ	DN 65	DN 65	1528	1435	408	1460	1747	116	1026	957	686		
50/160-150-6.8/0.55 DJ	DN 65	DN 80	1520	1420	368	1460	1547	116	1026	961	524		
50/160-154-10.5/0.55 DJ	DN 65	DN 80	1520	1420	368	1460	1547	116	1026	961	579		
50/160-170-12.9/0.55 DJ	DN 65	DN 80	1520	1420	368	1460	1747	116	1026	961	584		
50/200-175-12.9/0.55 DJ	DN 65	DN 80	1540	1440	368	1460	1747	116	1026	961	590		
50/200-185-12.9/0.75 DJ	DN 65	DN 80	1540	1440	368	1460	1747	116	1026	961	593		
50/200-195-17.7/1.1 DJ	DN 65	DN 80	1540	1440	368	1460	1747	116	1026	961	631		
50/200-204-17.7/1.1 DJ	DN 65	DN 80	1540	1440	368	1460	1747	116	1026	961	631		
50/200-208-26.5/1.1 DJ	DN 65	DN 80	1540	1440	388	1460	1747	116	1026	961	686		
50/200-215-26.5/1.1 DJ	DN 65	DN 80	1540	1440	388	1460	1747	116	1026	961	686		
50/250-230-26.5/1.1 DJ	DN 65	DN 80	1590	1490	408	1460	1747	116	1026	961	693		
50/250-243-26.5/1.1 DJ	DN 65	DN 80	1590	1490	408	1460	2098	116	1026	961	693		
50/250-257-31.5/1.1 DJ	DN 65	DN 80	1590	1490	388	1460	2098	116	1026	961	803		
65/200-185-17.7/0.55 DJ	DN 80	DN 100	1690	1580	388	1460	1747	116	1026	961	637		
65/200-197-26.5/0.75 DJ	DN 80	DN 100	1690	1580	408	1460	1747	116	1026	961	695		
65/200-209-26.5/1.1 DJ	DN 80	DN 100	1690	1580	408	1460	2098	116	1026	961	696		
65/200-214-31.5/1.1 DJ	DN 80	DN 100	1690	1580	388	1460	2098	116	1026	961	806		
65/250-223-31.5/1.1 DJ	DN 80	DN 100	1750	1640	415	1460	2098	116	1026	961	833		
65/250-240-47.7/1.1 DJ	DN 80	DN 100	1750	1640	415	1460	2098	116	1026	961	869		
65/250-252-47.7/1.1 DJ	DN 80	DN 100	1750	1640	415	1460	2098	116	1026	961	869		
65/250-259-66/1.1 DJ	DN 80	DN 100	1750	1640	415	1460	2098	116	1026	961	903		
65/315-292-100/1,5 DJ	DN 80	DN 150	2015	1905	648	1460	2678	143	1582	1517	1066		
80/200-192R-31.5/0.75 DJ	DN 100	DN 125	1860	1735	395	1460	2098	125	1026	965	831		
80/200-203-47.7/1.1 DJ	DN 100	DN 125	1860	1735	395	1460	2098	125	1026	965	868		
80/200-215.5-47.7/1.1 DJ	DN 100	DN 125	1860	1735	395	1460	2098	125	1026	965	868		
80/250-235-66/1.1 DJ	DN 100	DN 125	1910	1785	415	1460	2098	125	1026	1517	914		
80/250-243-66/1,1 DJ	DN 100	DN 125	1910	1785	415	1460	2098	125	1026	1517	950		
80/250-253-100/1,1 DJ	DN 100	DN 150	2152	2027	654	1460	2678	143	1582	1517	1075		
80/250-266-100/1,1 DJ	DN 100	DN 150	2152	2027	654	1460	2678	143	1582	1517	1075		
80/315-290-109/1,5 DJ	DN 100	DN 125	2219	2094	689	1460	2678	125	1582	1521	1115		
80/315-311-145/1,5 DJ	DN 100	DN 125	2219	2094	689	1460	2678	125	1582	1521	1120		
100/200-168R-26.5/0.55 DJ	DN 125	DN 150	2113	1970	435	1460	2098	143	1026	965	734		
100/200-183-31.5/0.55 DJ	DN 125	DN 150	2113	1970	415	1460	2098	143	1026	965	844		
100/200-194-47.7/0.75 DJ	DN 125	DN 150	2113	1970	415	1460	2098	143	1026	965	883		
100/200-205-47.7/0.75 DJ	DN 125	DN 150	2113	1970	415	1460	2098	143	1026	965	883		
100/200-219-66/1.1 DJ	DN 125	DN 150	2113	1970	415	1460	2098	143	1026	965	918		
100/250-233-66/1.1 DJ	DN 125	DN 150	2143	2000	440	1460	2098	143	1026	965	932		
100/250-247-100/1,1 DJ	DN 125	DN 150	2328	2203	689	1460	2678	143	1582	1521	1124		
100/250-256-100/1,1 DJ	DN 125	DN 150	2328	2203	689	1460	2678	143	1582	1521	1124		

Fire fighting

Fire extinguishing systems



Technical data Wilo-SiFire EN

Dimensions, weights

SiFire EN...	Nominal diameters of the pipe connections on suction side	Nominal diameters of pipe connections on the pressure side	Dimensions								Weight approx.			
			<i>RPS</i>	<i>RPD</i>	<i>H</i>	<i>H1</i>	<i>H2</i>	<i>HB</i>	<i>L</i>	<i>L1</i>		<i>P</i>	<i>T</i>	<i>m</i>
			mm										kg	
100/250-269-109/1,1 DJ	DN 125	DN 150	2328	2203	689	1460	2678	143	1582	1521	1144			
100/315-272-145/1,5 DJ	DN 125	DN 150	2380	2237	689	1460	2678	143	1582	1521	1165			
100/315-294-197/1,5 DJ	DN 125	DN 150	2380	2237	689	1460	2678	143	1582	1521	1316			
125/250-224-100/1,1 DJ	DN 150	DN 200	2433	2263	689	1460	2678	170	1582	1525	1175			
125/250-237-109/1,1 DJ	DN 150	DN 200	2433	2263	689	1460	2678	170	1582	1525	1195			
125/250-251-145/1,1 DJ	DN 150	DN 200	2433	2263	689	1460	2678	170	1582	1525	1200			
125/250-267-197/1,1 DJ	DN 150	DN 200	2433	2263	689	1460	2678	170	1582	1525	1351			
125/315-290-197/1,5 DJ	DN 150	DN 200	2434	2264	683	1460	2678	170	1582	1525	1400			
150/315-273-222/1,1 DJ	DN 200	DN 250	2778	2576	729	1460	2678	203	1582	1529	1553			
150/315-279-222/1,1 DJ	DN 200	DN 250	2778	2576	729	1460	2678	203	1582	1529	1553			
150/315-291-246/1,5 DJ	DN 200	DN 250	2778	2576	729	1460	2678	203	1582	1529	1555			

Fire fighting

Fire extinguishing systems

Technical data Wilo-SiFire EN

Dimension drawing

SiFire EN Electric, Diesel, Jockey

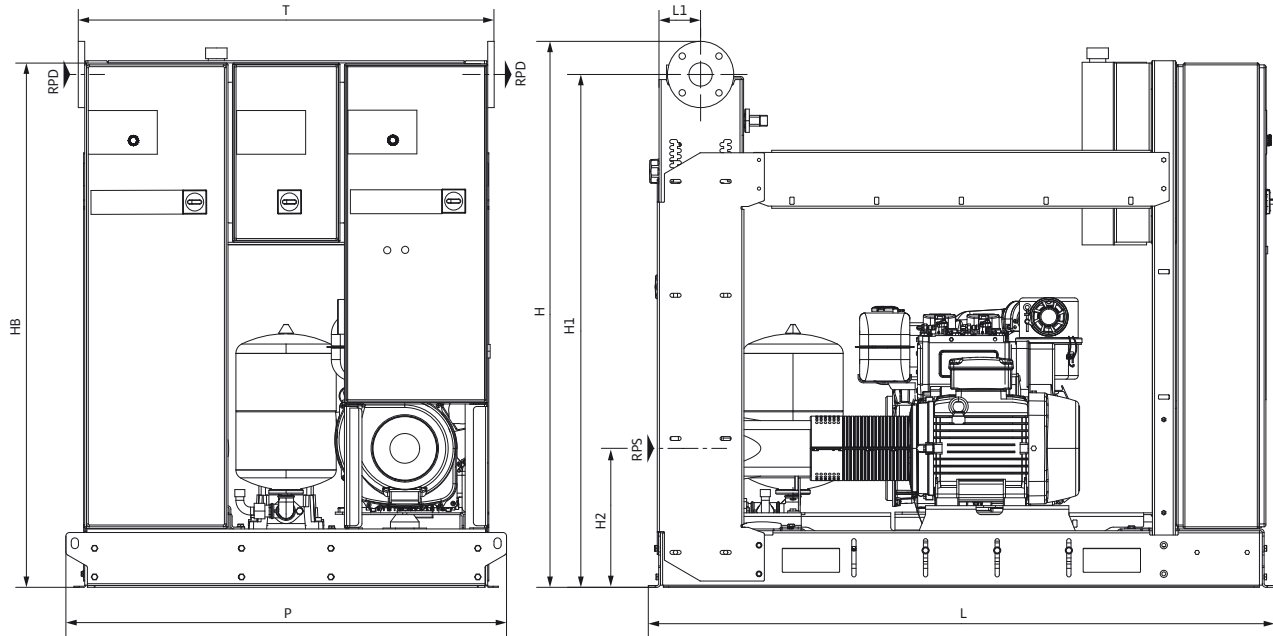

Sample systems are shown.

Accessories are to be ordered separately.

Installation surface: flat and horizontal

Installation location: dry, well ventilated and frost-proof

Dimensions, weights

SiFire EN...	Nominal diameters of the pipe connections on suction side	Nominal diameters of pipe connections on the pressure side	Dimensions								Weight approx.		
			RPS	RPD	H	H1	H2	HB	L	L1		P	T
			mm										
32/200-177-4/4.25/0.55 EDJ	DN 50	DN 65	1463	1370	368	1460	1547	116	1230	1161	668		
32/200-193-5.5/6.8/0.55 EDJ	DN 50	DN 65	1463	1370	368	1460	1547	116	1230	1161	705		
32/200-205-7.5/6.8/0.75 EDJ	DN 50	DN 65	1463	1370	368	1460	1547	116	1230	1161	721		
32/200-210-7.5/10.5/0.75 EDJ	DN 50	DN 65	1463	1370	368	1460	1547	116	1230	1161	751		
32/250-210-15/17.7/1.1 EDJ	DN 50	DN 65	1528	1435	388	1460	1747	116	1230	1161	884		
32/250-225-18.5/26.5/1.1 EDJ	DN 50	DN 65	1528	1435	408	1460	1747	116	1230	1161	951		
32/250-235-22/26.5/1.1 EDJ	DN 50	DN 65	1528	1435	408	1460	1747	116	1230	1161	991		
32/250-257-30/31.5/1.1 EDJ	DN 50	DN 65	1528	1435	388	1460	2098	116	1582	1513	1203		
40/200-180-7.5/10.5/0.55 EDJ	DN 65	DN 65	1463	1370	368	1460	1547	116	1230	1161	752		
40/200-195-11/10.5/0.75 EDJ	DN 65	DN 65	1463	1370	368	1460	1747	116	1230	1161	806		
40/200-200-11/12.9/0.75 EDJ	DN 65	DN 65	1463	1370	368	1460	1747	116	1230	1161	806		
40/200-210-15/12.9/1.1 EDJ	DN 65	DN 65	1463	1370	368	1460	1747	116	1230	1161	835		
40/250-198-11/12.9/0.75 EDJ	DN 65	DN 65	1528	1435	388	1460	1747	116	1230	1161	824		
40/250-205-15/12.9/1.1 EDJ	DN 65	DN 65	1528	1435	388	1460	1747	116	1230	1161	853		

Fire fighting

Fire extinguishing systems



Technical data Wilo-SiFire EN

Dimensions, weights

SiFire EN...	Nominal diameters of the pipe connections on suction side	Nominal diameters of pipe connections on the pressure side	Dimensions								Weight approx. <i>m</i> kg		
			<i>RPS</i>	<i>RPD</i>	<i>H</i>	<i>H1</i>	<i>H2</i>	<i>HB</i>	<i>L</i>	<i>L1</i>		<i>P</i>	<i>T</i>
			mm										
40/250-219-15/17.7/1.1 EDJ	DN 65	DN 65	1528	1435	388	1460	1747	116	1230	1161	890		
40/250-230-18.5/17.7/1.1 EDJ	DN 65	DN 65	1528	1435	388	1460	1747	116	1230	1161	902		
40/250-235-18.5/26.5/1.1 EDJ	DN 65	DN 65	1528	1435	408	1460	1747	116	1230	1161	957		
40/250-248-22/26.5/1.1 EDJ	DN 65	DN 65	1528	1435	408	1460	1747	116	1230	1161	997		
50/160-150-7.5/6.8/0.55 EDJ	DN 65	DN 80	1520	1420	368	1460	1547	116	1230	1165	724		
50/160-154-7.5/10.5/0.55 EDJ	DN 65	DN 80	1520	1420	368	1460	1547	116	1230	1165	754		
50/160-170-11/12.9/0.55 EDJ	DN 65	DN 80	1520	1420	368	1460	1747	116	1230	1165	805		
50/200-175-11/12.9/0.55 EDJ	DN 65	DN 80	1540	1440	368	1460	1747	116	1230	1165	817		
50/200-185-15/12.9/0.75 EDJ	DN 65	DN 80	1540	1440	368	1460	1747	116	1230	1165	848		
50/200-195-15/17.7/1.1 EDJ	DN 65	DN 80	1540	1440	368	1460	1747	116	1230	1165	886		
50/200-204-18.5/17.7/1.1 EDJ	DN 65	DN 80	1540	1440	368	1460	1747	116	1230	1165	898		
50/200-208-18.5/26.5/1.1 EDJ	DN 65	DN 80	1540	1440	388	1460	1747	116	1230	1165	953		
50/200-215-22/26.5/1.1 EDJ	DN 65	DN 80	1540	1440	408	1460	1747	116	1230	1165	993		
50/250-230-22/26.5/1.1 EDJ	DN 65	DN 80	1590	1490	408	1460	1747	116	1230	1165	1007		
50/250-243-30/26.5/1.1 EDJ	DN 65	DN 80	1590	1490	408	1460	2098	116	1582	1517	1189		
50/250-257-30/31.5/1.1 EDJ	DN 65	DN 80	1590	1490	388	1460	2098	116	1582	1517	1219		
65/200-185-18.5/17.7/0.55 EDJ	DN 80	DN 100	1690	1580	388	1460	1747	116	1230	1165	910		
65/200-197-22/26.5/0.75 EDJ	DN 80	DN 100	1690	1580	408	1460	1747	116	1230	1165	1008		
65/200-209-30/26.5/1.1 EDJ	DN 80	DN 100	1690	1580	408	1460	2098	116	1582	1517	1191		
65/200-214-30/31.5/1.1 EDJ	DN 80	DN 100	1690	1580	388	1460	2098	116	1582	1517	1221		
65/250-223-30/31.5/1.1 EDJ	DN 80	DN 100	1750	1640	415	1460	2098	116	1582	1517	1275		
65/250-240-37/47.7/1.1 EDJ	DN 80	DN 100	1750	1640	415	1460	2098	116	1582	1517	1350		
65/250-252-45/47.7/1.1 EDJ	DN 80	DN 100	1750	1640	415	1460	2098	116	1582	1517	1451		
65/250-259-55/66/1.1 EDJ	DN 80	DN 100	1750	1640	415	1460	2098	116	1582	1517	1542		
80/200-192R-30/31.5/0.75 EDJ	DN 100	DN 125	1860	1735	395	1460	2098	125	1582	1521	1275		
80/200-203-37/47.7/1.1 EDJ	DN 100	DN 125	1860	1735	395	1460	2098	125	1582	1521	1351		
80/200-215.5-45/47.7/1.1 EDJ	DN 100	DN 125	1860	1735	395	1460	2098	125	1582	1521	1452		
80/250-235-55/66/1.1 EDJ	DN 100	DN 125	1910	1785	415	1460	2098	125	1582	1521	1567		
100/200-168R-22/26.5/0.55 EDJ	DN 125	DN 150	2113	1970	435	1460	2098	143	1582	1521	861		
100/200-183-30/31.5/0.55 EDJ	DN 125	DN 150	2113	1970	415	1460	2098	143	1582	1521	953		
100/200-194-37/47.7/0.75 EDJ	DN 125	DN 150	2113	1970	415	1460	2098	143	1582	1521	1031		
100/200-205-45/47.7/0.75 EDJ	DN 125	DN 150	2113	1970	415	1460	2098	143	1582	1521	1132		
100/200-219-55/66/1.1 EDJ	DN 125	DN 150	2113	1970	415	1460	2098	143	1582	1521	1224		
100/250-233-55/66/1.1 EDJ	DN 125	DN 150	2143	2000	440	1460	2098	143	1582	1521	1252		

Fire fighting

Fire extinguishing systems

Technical data Wilo-SiFire EN

Dimension drawing

SiFire EN Electric, Electric, Jockey

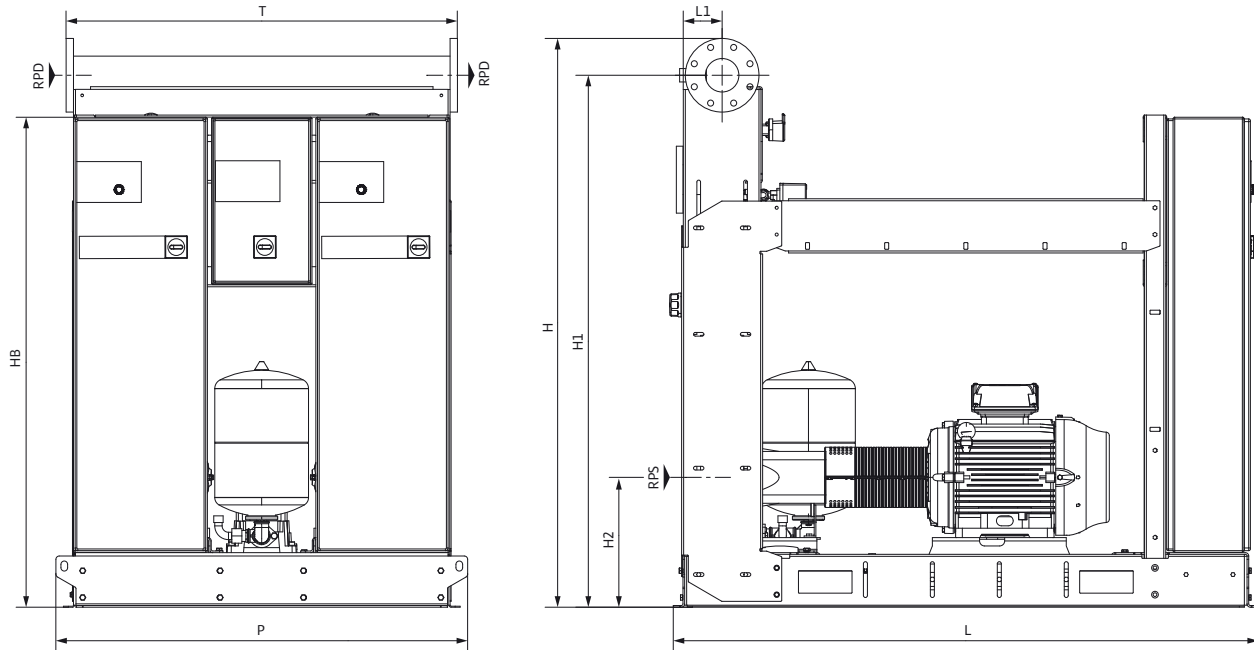

Sample systems are shown.
 Accessories are to be ordered separately.
 Installation surface: flat and horizontal
 Installation location: dry, well ventilated and frost-proof

Dimensions, weights

SiFire EN...	Nominal diameters of the pipe connections on suction side	Nominal diameters of pipe connections on the pressure side	Dimensions								Weight approx.		
			RPS	RPD	H	H1	H2	HB	L	L1		P	T
			mm										m
32/200-177-4/4/0.55 EEJ	DN 50	DN 65	1463	1370	368	1460	1547	116	1230	1161	613		
32/200-193-5.5/5.5/0.55 EEJ	DN 50	DN 65	1463	1370	368	1460	1547	116	1230	1161	657		
32/200-205-7.5/7.5/0.75 EEJ	DN 50	DN 65	1463	1370	368	1460	1547	116	1230	1161	681		
32/200-210-7.5/7.5/0.75 EEJ	DN 50	DN 65	1463	1370	368	1460	1547	116	1230	1161	681		
32/250-210-15/15/1.1 EEJ	DN 50	DN 65	1528	1435	388	1460	1747	116	1230	1161	806		
32/250-225-18.5/18.5/1.1 EEJ	DN 50	DN 65	1528	1435	388	1460	1747	116	1230	1161	830		
32/250-235-22/22/1.1 EEJ	DN 50	DN 65	1528	1435	388	1460	1747	116	1230	1161	910		
32/250-257-30/30/1.1 EEJ	DN 50	DN 65	1528	1435	388	1460	2098	116	1582	1513	1134		
40/200-180-7.5/7.5/0.55 EEJ	DN 65	DN 65	1463	1370	368	1460	1547	116	1230	1161	682		
40/200-195-11/11/0.75 EEJ	DN 65	DN 65	1463	1370	368	1460	1747	116	1230	1161	777		
40/200-200-11/11/0.75 EEJ	DN 65	DN 65	1463	1370	368	1460	1747	116	1230	1161	777		
40/200-210-15/15/1.1 EEJ	DN 65	DN 65	1463	1370	368	1460	1747	116	1230	1161	794		
40/250-198-11/11/0.75 EEJ	DN 65	DN 65	1528	1435	388	1460	1747	116	1230	1161	795		
40/250-205-15/15/1.1 EEJ	DN 65	DN 65	1528	1435	388	1460	1747	116	1230	1161	812		
40/250-219-15/15/1.1 EEJ	DN 65	DN 65	1528	1435	388	1460	1747	116	1230	1161	812		

Fire fighting

Fire extinguishing systems



Technical data Wilo-SiFire EN



Dimensions, weights

SiFire EN...	Nominal diameters of the pipe connections on suction side	Nominal diameters of pipe connections on the pressure side	Dimensions								Weight approx.		
			<i>RPS</i>	<i>RPD</i>	<i>H</i>	<i>H1</i>	<i>H2</i>	<i>HB</i>	<i>L</i>	<i>L1</i>		<i>P</i>	<i>T</i>
			mm									<i>m</i>	
40/250-230-18.5/18.5/1.1 EEJ	DN 65	DN 65	1528	1435	388	1460	1747	116	1230	1161	836		
40/250-235-18.5/18.5/1.1 EEJ	DN 65	DN 65	1528	1435	388	1460	1747	116	1230	1161	836		
40/250-248-22/22/1.1 EEJ	DN 65	DN 65	1528	1435	388	1460	1747	116	1230	1165	916		
50/160-150-7.5/7.5/0.55 EEJ	DN 65	DN 80	1520	1420	368	1460	1547	116	1230	1165	684		
50/160-154-7.5/7.5/0.55 EEJ	DN 65	DN 80	1520	1420	368	1460	1547	116	1230	1165	684		
50/160-170-11/11/0.55 EEJ	DN 65	DN 80	1520	1420	368	1460	1747	116	1230	1165	776		
50/200-175-11/11/0.55 EEJ	DN 65	DN 80	1540	1440	368	1460	1747	116	1230	1165	788		
50/200-185-15/15/0.75 EEJ	DN 65	DN 80	1540	1440	368	1460	1747	116	1230	1165	807		
50/200-195-15/15/1.1 EEJ	DN 65	DN 80	1540	1440	368	1460	1747	116	1230	1165	808		
50/200-204-18.5/18.5/1.1 EEJ	DN 65	DN 80	1540	1440	368	1460	1747	116	1230	1165	832		
50/200-208-18.5/18.5/1.1 EEJ	DN 65	DN 80	1540	1440	368	1460	1747	116	1230	1165	832		
50/200-215-22/22/1.1 EEJ	DN 65	DN 80	1540	1440	368	1460	1747	116	1230	1165	912		
50/250-230-22/22/1.1 EEJ	DN 65	DN 80	1590	1490	388	1460	1747	116	1230	1165	926		
50/250-243-30/30/1.1 EEJ	DN 65	DN 80	1590	1490	388	1460	2098	116	1582	1517	1150		
50/250-257-30/30/1.1 EEJ	DN 65	DN 80	1590	1490	388	1460	2098	116	1582	1517	1150		
65/200-185-18.5/18.5/0.55 EEJ	DN 80	DN 100	1690	1580	388	1460	1747	116	1230	1165	844		
65/200-197-22/22/0.75 EEJ	DN 80	DN 100	1690	1580	388	1460	1747	116	1230	1165	927		
65/200-209-30/30/1.1 EEJ	DN 80	DN 100	1690	1580	388	1460	2098	116	1582	1517	1152		
65/200-214-30/30/1.1 EEJ	DN 80	DN 100	1690	1580	388	1460	2098	116	1582	1517	1152		
65/250-223-30/30/1.1 EEJ	DN 80	DN 100	1750	1640	415	1460	2098	116	1582	1517	1206		
65/250-240-37/37/1.1 EEJ	DN 80	DN 100	1750	1640	415	1460	2098	116	1582	1517	1284		
65/250-252-45/45/1.1 EEJ	DN 80	DN 100	1750	1640	415	1460	2098	116	1582	1517	1486		
65/250-259-55/55/1.1 EEJ	DN 80	DN 100	1750	1640	415	1460	2098	116	1582	1517	1600		
80/200-192R-30/30/0.75 EEJ	DN 100	DN 125	1860	1735	395	1460	2098	125	1582	1521	1206		
80/200-203-37/37/1.1 EEJ	DN 100	DN 125	1860	1735	395	1460	2098	125	1582	1521	1285		
80/200-215.5-45/45/1.1 EEJ	DN 100	DN 125	1860	1735	395	1460	2098	125	1582	1521	1487		
80/250-235-55/55/1.1 EEJ	DN 100	DN 125	1910	1785	415	1460	2098	125	1582	1521	1625		
100/200-168R-22/22/0.55 EEJ	DN 125	DN 150	2113	1970	415	1460	2098	143	1582	1521	1010		
100/200-183-30/30/0.55 EEJ	DN 125	DN 150	2113	1970	415	1460	2098	143	1582	1521	1234		
100/200-194-37/37/0.75 EEJ	DN 125	DN 150	2113	1970	415	1460	2098	143	1582	1521	1315		
100/200-205-45/45/0.75 EEJ	DN 125	DN 150	2113	1970	415	1460	2098	143	1582	1521	1517		
100/200-219-55/55/1.1 EEJ	DN 125	DN 150	2113	1970	415	1460	2098	143	1582	1521	1632		
100/250-233-55/55/1.1 EEJ	DN 125	DN 150	2143	2000	440	1460	2098	143	1582	1521	1660		

Fire fighting

Fire extinguishing systems

Accessories Wilo-Sifire EN

Accessories				
Type	Product photo	Description		Art no.
Flange connection eccentric cone		Flange reducer on the suction side of the pump and for holding the shut-off valve	DN 50x65	4177430
			DN 50x80	4177431
			DN 50x100	4177432
			DN 65x80	4177433
			DN 65x100	4177434
			DN 65x125	4177435
			DN 65x150	4177436
			DN 80x100	4177437
			DN 80x125	4177438
			DN 80x150	4177439
			DN 80x200	4177440
			DN 100x125	4177441
			DN 100x150	4177442
			DN 100x200	4177443
			DN 100x250	4177444
			DN 125x150	4177445
			DN 125x200	4177446
			DN 125x250	4177447
DN 150x200	4177448			
DN 150x250	4177449			
DN 150x300	4177450			
DN 150x350	4177451			
DN 200x300	4177452			
DN 200x350	4177453			
Throttle shut-off valve with handle			DN 65 - PN 10	4177454
			DN 80 - PN 10	4177455
			DN 100 - PN 10	4177456
			DN 125 - PN 10	4177457
			DN 150 - PN 10	4177458
			DN 150 - PN 10	4177459
			DN 250 - PN 10	4177460
			DN 300 - PN 10	4177461
DN 350 - PN 10	4177462			
Throttle shut-off valve with worm drive		Shut-off valve for the suction and pressure side with electrical contact	DN 65 - PN 10	4177463
			DN 80 - PN 10	4177464
			DN 100 - PN 10	4177465
			DN 125 - PN 10	4177466
			DN 150 - PN 10	4177467
			DN 150 - PN 10	4177468
			DN 250 - PN 10	4177469
			DN 300 - PN 10	4177470
DN 350 - PN 10	4177471			

Fire fighting

Fire extinguishing systems



Accessories Wilo-Sifire EN

Accessories				
Type	Product photo	Description		Art no.
Flow meter			DN 40	4177472
			DN 50	4177473
			DN 65	4177474
			DN 80	4177475
			DN 100	4177476
			DN 125	4177477
			DN 150	4177478
			DN 200	4177479
Supply tank kit		Horizontal supply tank (500L) with float valve and pressure switch for alarm in the event of a water shortage	500 litres	4177480
Limit switch for handle/worm drive		Limit switches for the shut-off valves		4177481
Rubber compensator		Damping of the vibrations on the pipe-work provided by the customer	DN 65	4015745
			DN 80	4015461
			DN 100	4015746
			DN 125	4015747
			DN 150	4015748
			DN 200	4015749
			DN 250	4177482
DN 300	4177483			

Fire fighting

Fire extinguishing systems

Accessories Wilo-Sifire EN

Accessories



Type	Product photo	Description		Art no.
Alarm switchgear		Alarm activation in the event of a system fault and in the event of fire extinguishing	Type A & B	4177484
Diesel pump test		Testing and certification of the diesel pump	4.25 - 26.5 kW	4177485
			31.5 - 47.7 kW	4177486
			66 - 109 kW	4177487
			130 - 177 kW	4177488
			200 - 222 kW	4177489
Battery acid tester		Checking the battery for the diesel pump	-	4177491

Fire fighting

Fire extinguishing systems

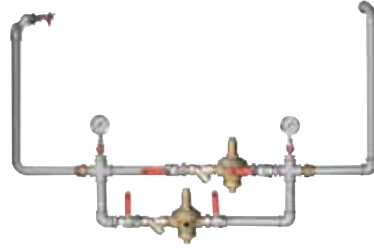

Accessories Wilo-Sifire EN

Accessories				
Type	Product photo	Description		Art no.
Diesel motor accessory set		Spare parts kit (timing belt, filter, gaskets, hoses) for the diesel motor	4.2 kW	4177492
			6.9 kW	4177493
			10.5/12.8 kW	4177494
			17.7 kW	4177495
			26.5 kW	4177496
			47.7 kW	4177497
			66 kW	4177498
			100 kW	4177499
			109/145 kW	4177500
197/246kW	4177501			
Diesel motor silencer		Silencer (30dBA) for the noise damping of the diesel motor	31.5/47.7kW	4177502
			66kW	4177507
			100/109kW	4177506
			145kW	4177505
			197/222kW	4177504
246kW	4177503			
Hydraul. Heat exchanger		Heat exchanger for cooling the diesel motor	31.5-47.7kW	4177512
			66-109kW	4177511
			>109kW	4177510

Fire extinguishing systems

Switchgears/control devices SiFire EN

Structure and function description Wilo-Control SC-Fire E



Wilo-Control SC-Fire E

Hardware

Fully electronic central control unit, installed in a painted steel enclosure, protection class IP54, control and display devices on the front door.

Set-up of the control device

The design of the control device depends on the power of the connected pump (start via DOL or star-delta connection). The device comprises the following components:

Main switch: For switching the switchgear on and off. (In the case of unauthorised use in the event of a fire.)

Display: Display built into the door of the switch cabinet for operation and display purposes. Shows the operating data and the operating status of the pump and controller through a combination of symbols and numerical codes. Menus are selected and parameters entered with the "red button".

Microprocessor with "Soft PLC": Microprocessor PLC ("Soft PLC"), implemented by the programming, power supply unit and I/O wiring. The configuration of the programming depends on the system and the sprinkler system.

Indicators: Long-life indicator lights indicate the operational readiness and operation of the pump, the activation of the pressure switch and float switch, a false start, a collective error, manual start and manual stop.

Buttons: Push buttons for manual start and manual stop, the lamp test and acknowledgement of alarms and warning messages.

Fuse protection: Fuses which tolerate the starting current for at least 20 s.

Motor startup: Contactor for direct-on-line starting, up to 22 kW, start by means of star-delta connection at higher power levels.

Motor protection: Only for signalling.

Monitoring of the water supply: By means of a float switch to ensure a minimum water level of 2/3 of the suction tank is always maintained.

Performance monitoring: Power supply and power of the pump.

Combined signal report: All types of errors are indicated by a common error indicator.

Individual signal report: The important "false start" error message is indicated by an individual error indicator.

Error message and acknowledgement: All error messages are indicated by LEDs, displayed as error codes and must be acknowledged.

Options

Software

- Factory-programmed for fully automatic operation.
- Information regarding voltage, current and power of the pump.
- Menu navigation with symbol representation.

Connection data

Function description

The Wilo SC Fire E control devices can be used to control pumps with an electric motor, sensors for pump management and the level of information. The SC unit is controlled by means of a microprocessor with "Soft PLC". It is used to control and regulate the necessary functions of pressure boosting systems for fire fighting in accordance with EN 12845 for test purposes and operation of the sprinkler system.

The operating logic for the fire extinguishing unit is based on the cascade calibration of the pressure switches for starting the pump. The pressure in the system decreases if a large quantity of water is requested due to the opening of one or more circuits or due to a defective sprinkler. The SC Fire controller then initiates the start-up of the main pump. If the electric main pump does not start in systems with multiple pumps (for example due to problems with the power supply), the pressure switch of the standby pump is activated by the drop in pressure and the pump starts. In some cases, two or more electric pumps can be used.

As soon as the sprinkler circuit or gate valve, via which the sprinkler heads are supplied, is closed, pressure is built up in the system. The stop buttons on the SC Fire must then be pressed to stop the main and standby pump.

Standards followed:

- Fixed Firefighting Systems - Automatic Sprinkler Systems - (EN 12845), part for pumps with electric motor
- Electrical Equipment of Machines (EN 60204-1)
- Low-voltage Switchgear and Controlgear Assemblies (EN 61439-1 and EN 61439-2)
- EMC - Immunity for Industrial Environments (EN 61000-6-2)
- EMC - Emission Standard for Residential, Commercial and Light-Industrial Environments (EN 61000-6-3)

Additional information:

A significant advantage of the Smart Controller SC Fire is the user friendliness of the proven Wilo red-button technology. At the heart of the SC is the "Soft PLC" programmable logic controller, which is based exclusively on Wilo's wealth of experience. All programming is implemented internally. These next generation control devices can therefore be used flexibly and fulfil customer-specific requirements in all markets.

Fire extinguishing systems

Switchgears/control devices SiFire EN



Structure and function description Wilo-Control SC-Fire D



Wilo-Control SC-Fire D

Hardware

Fully electronic central control unit, installed in a painted steel enclosure, protection class IP54, control and display devices on the front door.

Set-up of the control device

The design of the control device depends on the power of the connected pump. The device comprises the following components:

Main switch: For switching the switchgear on and off. (In the case of unauthorised use in the event of a fire.)

Display: Display built into the door of the switch cabinet for operation and display purposes. Shows the operating data and the operating status of the pump and controller through a combination of symbols and numerical codes. Menus are selected and parameters entered with the "red button".

Microprocessor with "Soft PLC": Microprocessor PLC ("Soft PLC"), implemented by the programming, power supply unit and I/O wiring. The configuration of the programming depends on the system and the sprinkler system.

Indicators: Longlife indicator lights which indicate the following: Operational readiness of the pump, operation of the pump, activation of the pressure switch, activation of the float switch, deactivation of automatic mode, deactivation of the motor heater, temperature alarm, oil pressure alarm, false start, belt alarm, low fuel level, collective error, manual stop.

Buttons: Push button for manual stop, start battery A, start battery B, lamp test and acknowledgement of alarms and warning messages.

Fuse protection: Protective fuses for heating and battery charging unit in the switch cabinet.

Motor startup: Automatic starting sequence with six start attempts by means of two alternating batteries or directly with the start button on the front panel.

Motor protection: Monitoring of typical operating parameters of the diesel motor (temperature, oil pressure etc.) without stopping.

Performance monitoring: Monitoring of the diesel motor speed.

Battery monitoring: Monitoring of charging voltage, charging current and charging errors.

Monitoring of the water supply: By means of a float switch to ensure a minimum water level of 2/3 of the suction tank is always maintained.

Monitoring of the power supply: Error message from the battery charging unit in the event of a power supply failure.

Combined signal report: All types of errors are indicated by a common error indicator.

Individual signal report: Important individual errors are indicated by individual error indicators.

Error message and acknowledgement: All error messages are indicated by LEDs, displayed as error codes and must be acknowledged.

Options

Software

- Factory-programmed for fully automatic operation.
- Information regarding motor speed, charging voltage and charging current.
- Menu navigation with symbol representation.

Connection data

Function description

Wilo SC Fire D control devices can be used to control pumps with a diesel motor, sensors for the pump management and the level of information. The SC unit is controlled by means of a microprocessor with "Soft PLC". It is used to control and regulate the necessary functions of pressure boosting systems for fire fighting in accordance with EN 12845 for test purposes and operation of the sprinkler system.

The operating logic for the fire extinguishing unit is based on the cascade calibration of the pressure switches for starting the pump. The pressure in the system decreases if a large quantity of water is requested due to the opening of one or more circuits or due to a defective sprinkler. The SC Fire controller then initiates the start-up of the diesel motor pump.

As soon as the sprinkler circuit or gate valve, via which the sprinkler heads are supplied, is closed, pressure is built up in the system. The stop buttons on the SC Fire must then be pressed to stop the pump.

Standards followed:

- Fixed Firefighting Systems - Automatic Sprinkler Systems - (EN 12845), part for pumps with diesel motor
- Electrical Equipment of Machines (EN 60204-1)
- Low-voltage Switchgear and Controlgear Assemblies (EN 61439-1 and EN 61439-2)
- EMC - Immunity for Industrial Environments (EN 61000-6-2)
- EMC - Emission Standard for Residential, Commercial and Light-Industrial Environments (EN 61000-6-3)

Additional information:

A significant advantage of the Smart Controller SC Fire is the user friendliness of the proven Wilo red-button technology. At the heart of the SC is the "Soft PLC" programmable logic controller, which is based exclusively on Wilo's wealth of experience. All programming is implemented internally. These next generation control devices can therefore be used flexibly and fulfil customer-specific requirements in all markets.

Fire extinguishing systems

Switchgears/control devices SiFire EN

Structure and function description Wilo-Control SC-Fire J



Standards followed:

- Fixed Firefighting Systems - Automatic Sprinkler Systems - (EN 12845), part for jockey pumps
- Electrical Equipment of Machines (EN 60204-1)
- Low-voltage Switchgear and Controlgear Assemblies (EN 61439-1 and EN 61439-2)
- EMC - Immunity for Industrial Environments (EN 61000-6-2)
- EMC - Emission Standard for Residential, Commercial and Light-Industrial Environments (EN 61000-6-3)

Wilo-Control SC-Fire J

Hardware

Complete electromechanical control unit, installed in a painted steel enclosure, protection class IP54, control devices and buttons on the front door.

Set-up of the control device

The design of the control device depends on the power of the connected pump. The device comprises the following components:

Main switch: For switching the switchgear on and off.

Indicators: Long-life indicator lights which indicate the operational readiness of the pump, operation of the pump and collective faults.

Switches: Rotary switch for setting the manual mode or automatic mode.

Motor startup: Direct contactor

Motor protection: Switch for protection against short-circuits and overloads.

Individual signal report: Motor error message (short-circuit, overload).

Error message and acknowledgement: The motor error message is indicated via corresponding LEDs. The error is acknowledged when the motor protection switch is restarted.

Connection data

Function description

The Wilo Control Fire J units can be used to control jockey pumps with an electric motor and sensors according to EN 12845, as well as for test purposes and the operation of the sprinkler system.

The operating logic for the fire extinguishing unit is based on the cascade calibration of the pressure switches for starting the pump. The jockey pump, which is used for pressure boosting, is started first and ensures that the system is filled with water and that it remains pressurised. It is activated in the event of a pressure drop in the system. A properly calibrated pressure switch is used for controlled starting and stopping procedures.