

Electropompes centrifuges normalisées "EN 733"

 Eaux claires

 Usage industriel



PLAGE DES PERFORMANCES

- Débit jusqu'à **3000 l/min** (180 m³/h)
- Hauteur manométrique totale jusqu'à **24 m**

LIMITES D'UTILISATION

- Hauteur manométrique d'aspiration jusqu'à **7 m**
- Température du liquide de **-10 °C à +90 °C**
- Température ambiante jusqu'à **-10 °C à +40 °C**
- Pression maxi dans le corps de pompe **10 bar** (PN10)
- Service continu **S1**

EXÉCUTION ET NORMES DE SÉCURITÉ

EN 60335-1
IEC 60335-1
CEI 61-150

EN 60034-1
IEC 60034-1
CEI 2-3



Dimensions corps de pompe selon: **EN 733**

REGLEMENT (UE) N. 547/2012

CERTIFICATIONS

Société avec système de gestion certifié DNV
ISO 9001: QUALITE
ISO 14001: ENVIRONNEMENT ET SECURITE



UTILISATIONS ET INSTALLATIONS

- Approvisionnement en eau
- Surpression
- Irrigation
- Circulation d'eau dans des installations de climatisation
- Installations de lavage
- Installations anti-incendie
- Industrie
- Agriculture

Elles doivent être installées dans des lieux fermés ou à l'abri des intempéries.

EXÉCUTIONS SUR DEMANDE

- KIT contrebrides avec vis, écrous et joints
- Autres tensions ou fréquence à 60 Hz
- Pour liquides avec températures plus élevées ou plus basses
- Pour environnements avec températures plus élevées ou plus basses

GARANTIE

2 ans selon nos conditions générales de vente

PLAGES DES PERFORMANCES

50 Hz n = 1450 rpm

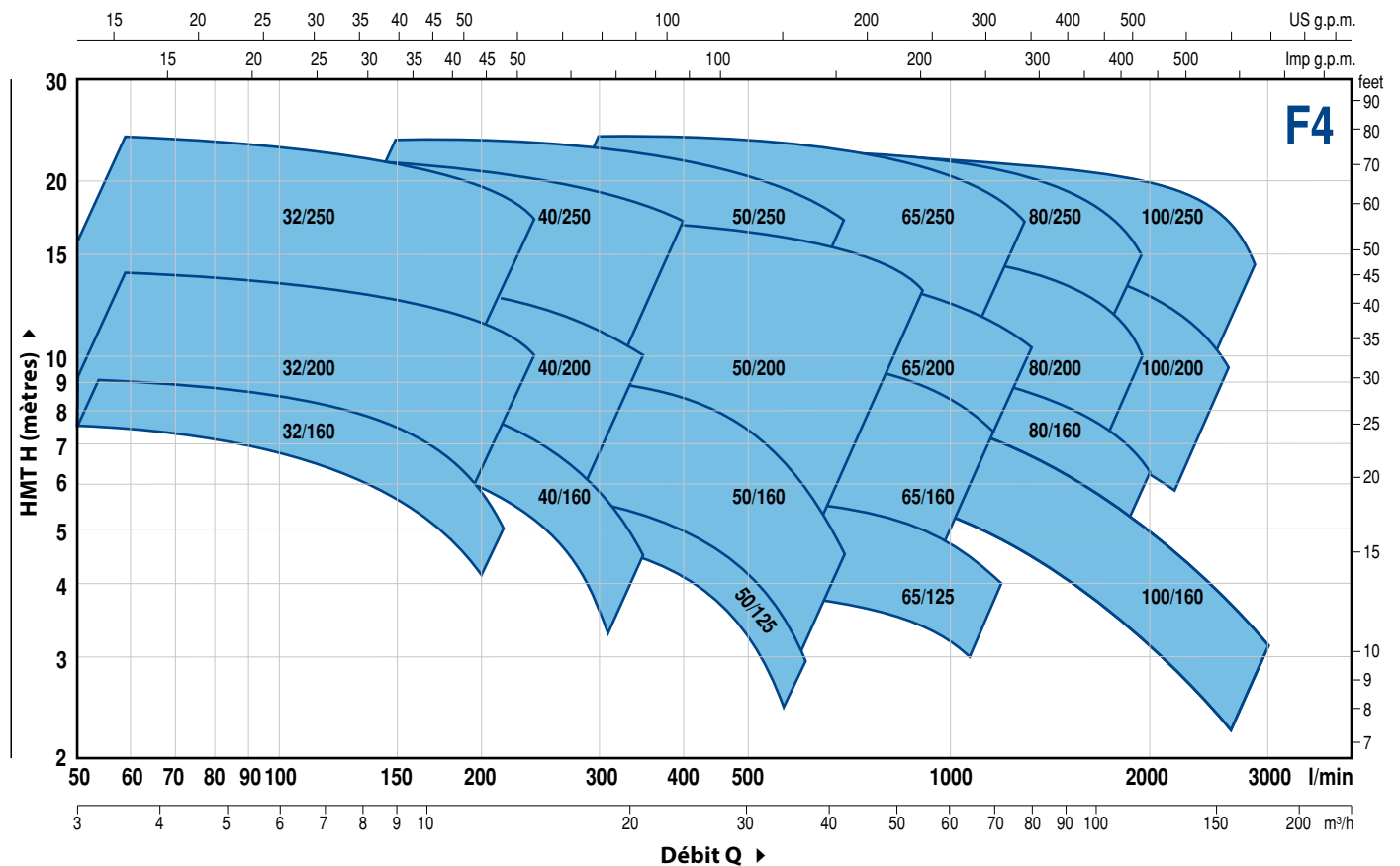

CARACTÉRISTIQUES DE PERFORMANCE

50 Hz n = 1450 rpm

TYPE	PUISSANCE (P ₂)			PERFORMANCES	
	kW	HP	▲	Q l/min	H mètres
F4-32/160B	0.37	0.5	IE2	50 ÷ 200	7.5 ÷ 4.5
F4-32/160A	0.37	0.5		50 ÷ 225	9 ÷ 5
F4-32/200B	0.75	1	IE2	50 ÷ 250	12.5 ÷ 9
F4-32/200A	1.1	1.5		50 ÷ 250	14 ÷ 10.5
F4-32/200BH	0.75	1	IE2	50 ÷ 150	11.3 ÷ 9.2
F4-32/200AH	0.75	1		50 ÷ 160	13.8 ÷ 11
F4-32-250C	1.1	1.5	IE2	50 ÷ 200	18.5 ÷ 13.5
F4-32-250B	1.5	2		50 ÷ 225	21.5 ÷ 15.5
F4-32-250A	2.2	3	IE3	50 ÷ 250	24 ÷ 16.5
F4-40/160B	0.37	0.5	IE2	50 ÷ 320	7.5 ÷ 3.5
F4-40/160A	0.55	0.75		50 ÷ 350	9 ÷ 4.5
F4-40/200B	0.75	1	IE2	50 ÷ 350	11.5 ÷ 7
F4-40/200A	1.1	1.5		50 ÷ 350	13.8 ÷ 10
F4-40/250C	1.1	1.5	IE2	50 ÷ 400	15.5 ÷ 10
F4-40/250B	1.5	2		50 ÷ 400	17.5 ÷ 12
F4-40/250A	2.2	3	IE3	50 ÷ 400	22 ÷ 17
F4-50/125B	0.55	0.75	IE2	150 ÷ 600	5 ÷ 2
F4-50/125A	0.55	0.75		150 ÷ 600	6 ÷ 3
F4-50/160B	0.75	1	IE2	150 ÷ 650	8 ÷ 3.8
F4-50/160A	1.1	1.5		150 ÷ 700	9.3 ÷ 4.5
F4-50/200C	1.5	2	IE3	200 ÷ 850	11 ÷ 7.5
F4-50/200B	2.2	3		200 ÷ 850	13 ÷ 9.5
F4-50/200A	2.2	3		200 ÷ 900	15 ÷ 11.2
F4-50/200AR	3	4		200 ÷ 900	17 ÷ 13.2
F4-50/250D	1.1	1.5		150 ÷ 650	12.5 ÷ 5
F4-50/250C	1.5	2	IE3	150 ÷ 700	14 ÷ 5
F4-50/250B	2.2	3		150 ÷ 700	18 ÷ 10.5
F4-50/250A	2.2	3		150 ÷ 700	20 ÷ 13
F4-50/250AR	3	4		150 ÷ 700	23.5 ÷ 17

TYPE	PUISSANCE (P ₂)			PERFORMANCES	
	kW	HP	▲	Q l/min	H mètres
F4-65/125B	0.75	1	IE2	300 ÷ 1100	4.7 ÷ 3
F4-65/125A	1.1	1.5		300 ÷ 1200	5.7 ÷ 4
F4-65/160C	1.1	1.5	IE2	300 ÷ 1100	8 ÷ 5.5
F4-65/160B	1.5	2		300 ÷ 1200	9.1 ÷ 5.7
F4-65/160A	2.2	3	IE3	300 ÷ 1200	10.1 ÷ 7
F4-65/200A	2.2	3		300 ÷ 1250	12 ÷ 8.5
F4-65/200AR	3	4	IE3	300 ÷ 1300	14 ÷ 10
F4-65/250B	4	5.5		200 ÷ 1250	21.8 ÷ 15.5
F4-65/250A	5.5	7.5	IE3	200 ÷ 1300	23.5 ÷ 17
F4-80/160D	1.5	2		IE3	300 ÷ 2000
F4-80/160C	2.2	3	300 ÷ 2000		7.5 ÷ 3.8
F4-80/160B	2.2	3	300 ÷ 2000		8.8 ÷ 5
F4-80/160A	3	4	300 ÷ 2000		10 ÷ 6.2
F4-80/200B	4	5.5	IE3	300 ÷ 1800	14 ÷ 9
F4-80/200A	5.5	7.5		300 ÷ 1900	15.5 ÷ 10.5
F4-80/250B	5.5	7.5	IE3	300 ÷ 1800	19.5 ÷ 13.5
F4-80/250A	7.5	10		300 ÷ 1950	22 ÷ 15
F4-100/160B-N	2.2	3	IE3	400 ÷ 2750	8.1 ÷ 2.7
F4-100/160A-N	3	4		400 ÷ 3000	9.2 ÷ 3.2
F4-100/200C	4	5.5	IE3	400 ÷ 2300	12.7 ÷ 7
F4-100/200B	5.5	7.5		400 ÷ 2400	14.2 ÷ 8.5
F4-100/200A	5.5	7.5		400 ÷ 2600	15.8 ÷ 9.5
F4-100/250B	7.5	10	IE3	400 ÷ 2600	18.5 ÷ 11.5
F4-100/250A	9.2	12.5		400 ÷ 2900	22 ÷ 13.5

Q = Débit

H = Hauteur manométrique totale

Tolérance des courbes de prestation selon EN ISO 9906 Degré 3B.

▲ Classe de rendement du moteur triphasé (IEC 60034-30)

F4-32/160

COURBES ET CARACTÉRISTIQUES DE PERFORMANCE

50 Hz n= 1450 rpm HS= 0 m

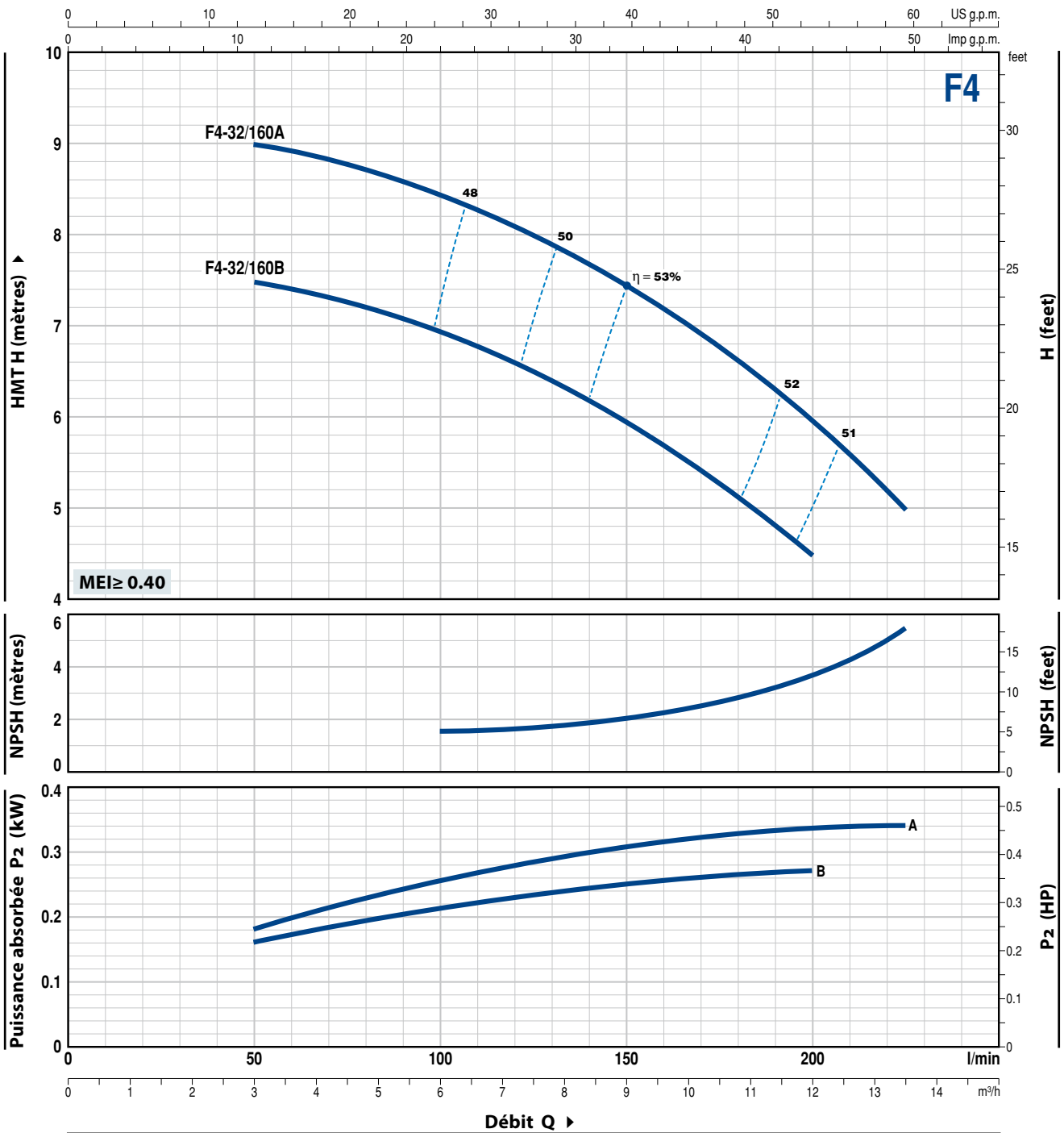

TYPE	PUISSANCE (P2)		Q	m³/h								
	kW	HP		3	4.5	6	7.5	9	10.8	12	13.5	
Triphasé			Q	50	75	100	125	150	180	200	225	
F4-32/160B	0.37	0.5	H mètres	7.5	7.3	6.9	6.5	6	5.1	4.5		
F4-32/160A	0.37	0.5		9	8.8	8.4	8	7.5	6.6	6	5	

Q = Débit H = Hauteur manométrique totale HS = Hauteur d'aspiration

Tolérance des courbes de prestation selon EN ISO 9906 Degré 3B.

COURBES ET CARACTÉRISTIQUES DE PERFORMANCE

50 Hz n= 1450 rpm HS= 0 m

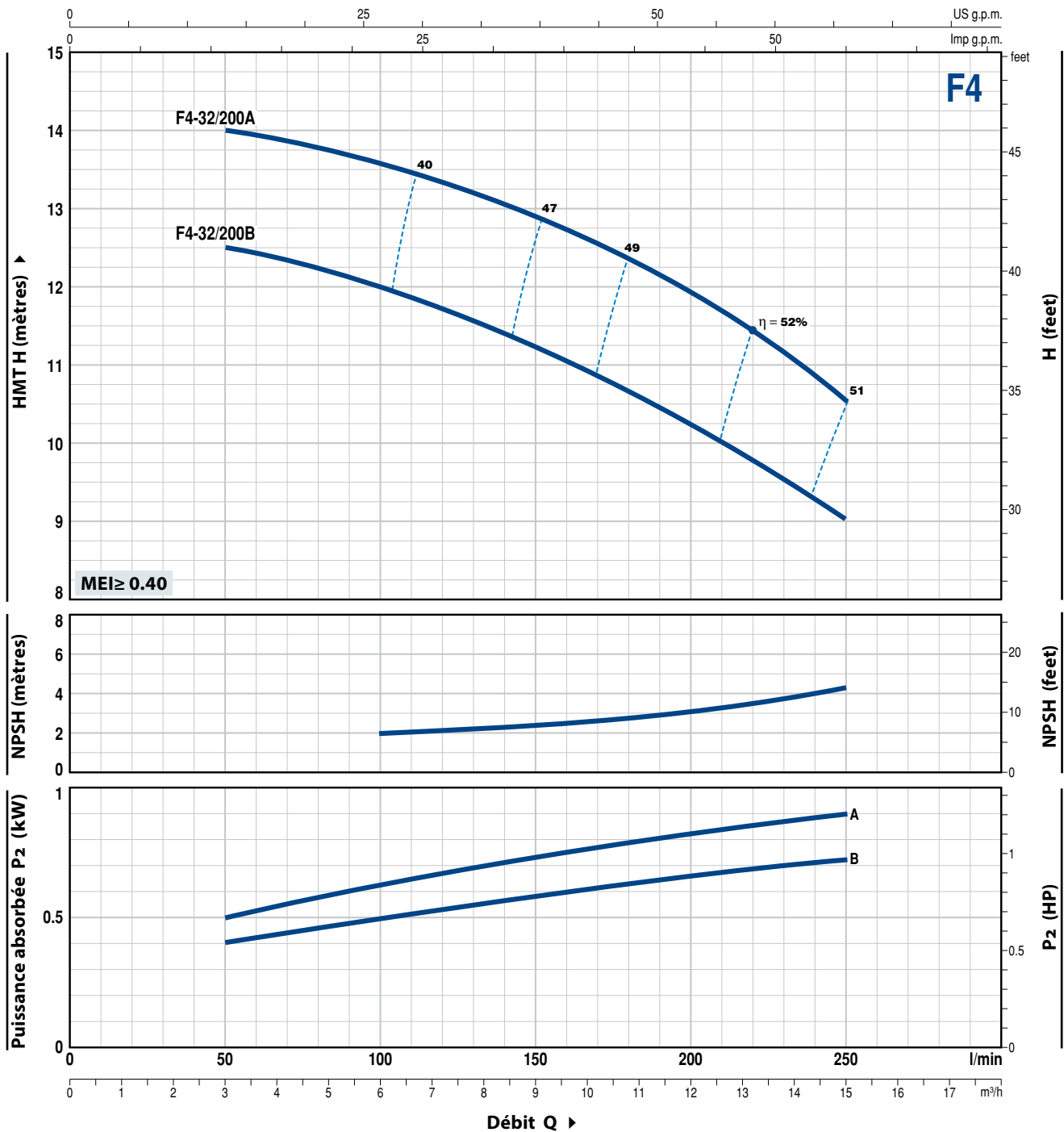

TYPE	PUISSANCE (P ₂)		Q	H				
	kW	HP		m ³ /h	l/min	mètres	feet	feet
Triphasé				3	6	9	12	15
				50	100	150	200	250
F4-32/200B	0.75	1	H mètres	12.5	12	11.2	10.3	9
F4-32/200A	1.1	1.5	H mètres	14	13,6	12.8	11.9	10.5

Q = Débit H = Hauteur manométrique totale HS = Hauteur d'aspiration

Tolérance des courbes de prestation selon EN ISO 9906 Degré 3B.

F4-32/200H

COURBES ET CARACTÉRISTIQUES DE PERFORMANCE

50 Hz n= 1450 rpm HS= 0 m

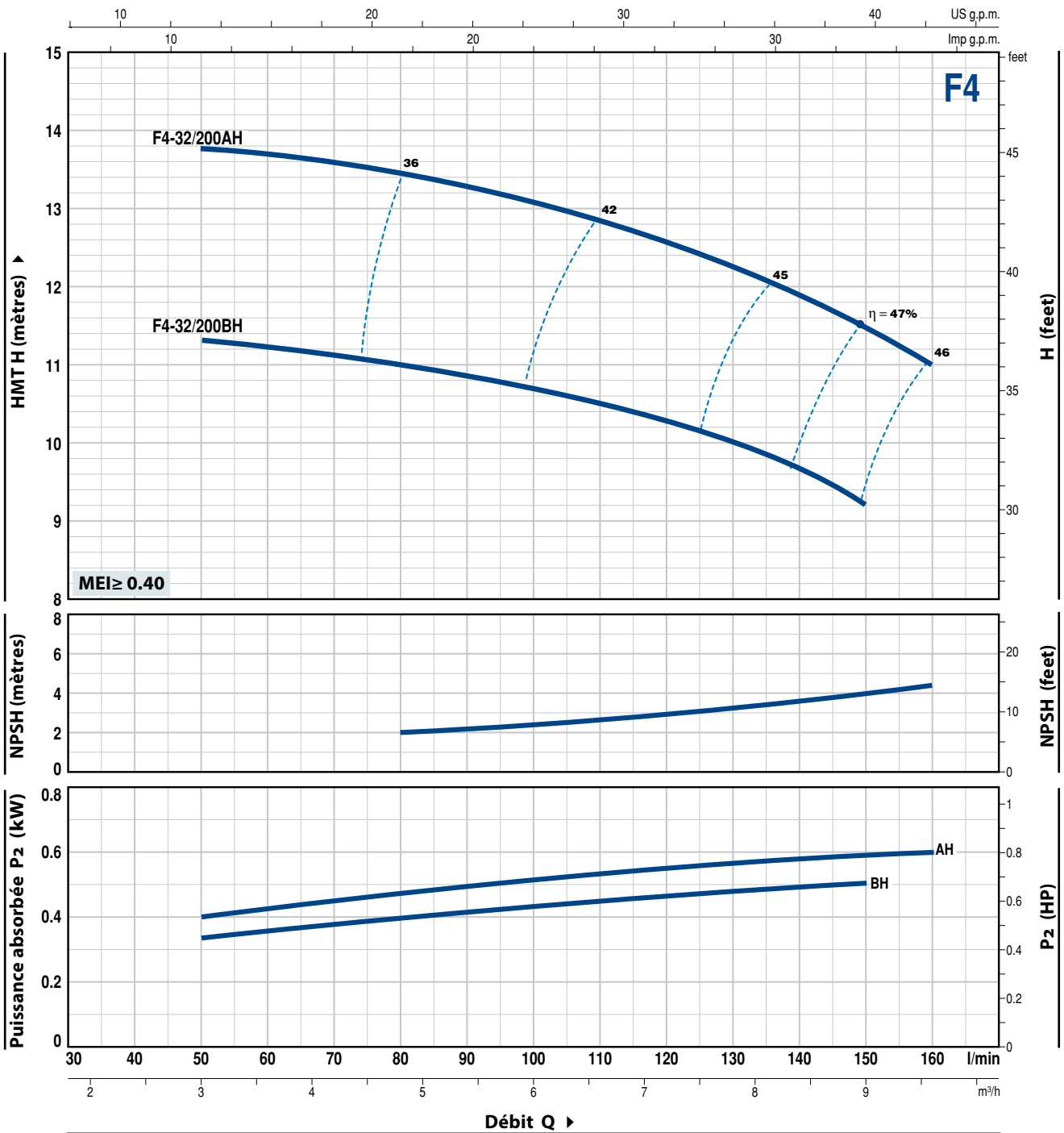

TYPE	PUISSANCE (P ₂)		Q	H							
	kW	HP		m ³ /h	3	4.2	5.4	6.6	7.8	9	9.6
Triphasé			l/min	50	70	90	110	130	150	160	
F4-32/200BH	0.75	1	H mètres	11.3	11.1	10.8	10.5	10	9.2		
F4-32/200AH	0.75	1	H mètres	13.8	13.6	13.3	12.8	12.2	11.5	11	

Q = Débit H = Hauteur manométrique totale HS = Hauteur d'aspiration

Tolérance des courbes de prestation selon EN ISO 9906 Degré 3B.

COURBES ET CARACTÉRISTIQUES DE PERFORMANCE

50 Hz n= 1450 rpm HS= 0 m

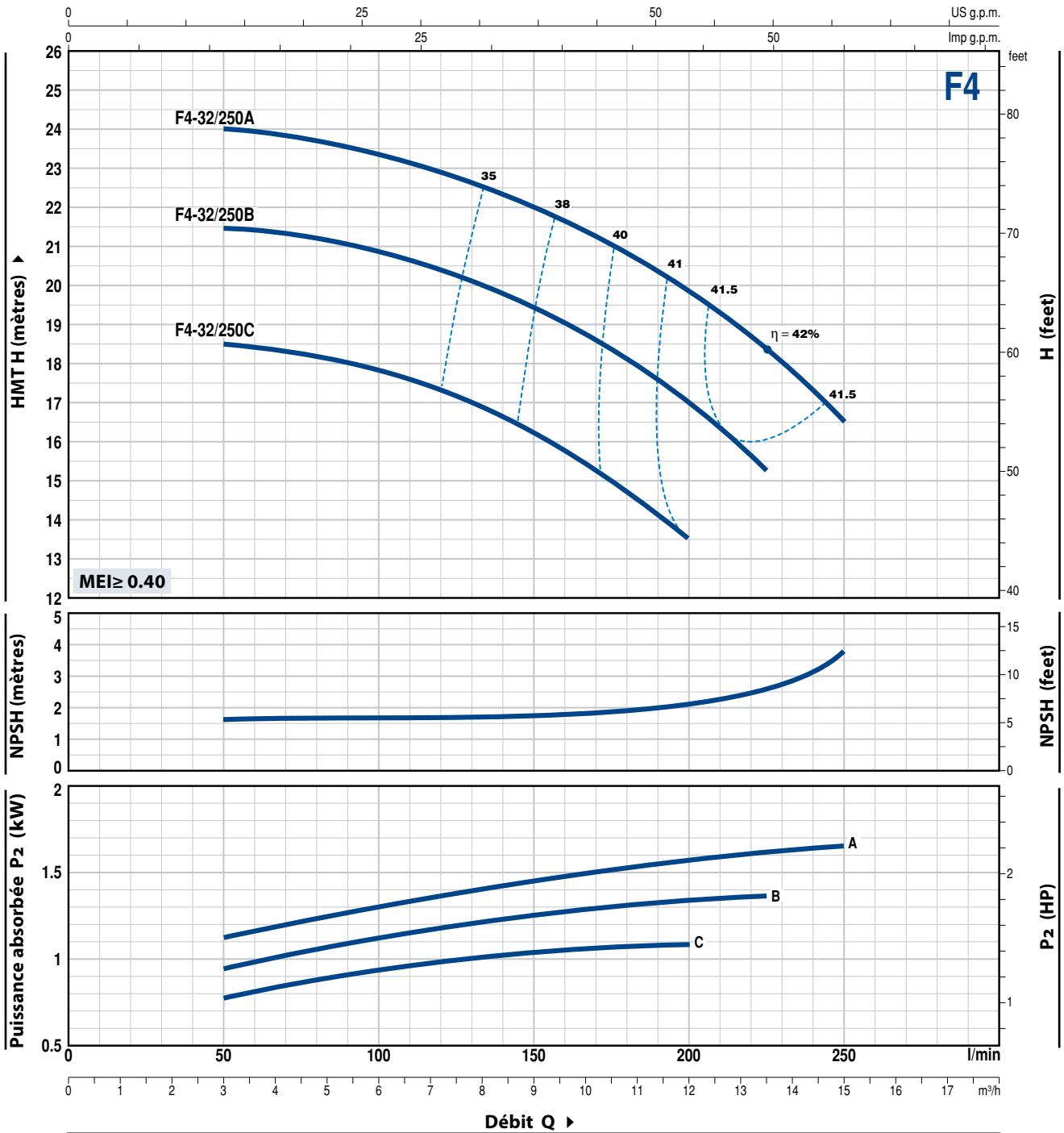

TYPE	PUISSANCE (P ₂)		Q	m ³ /h											
	kW	HP		3	4.5	6	7.5	9	10.5	12	13.5	15			
Triphasé			l/min	50	75	100	125	150	175	200	225	250			
F4-32/250C	1.1	1.5	H mètres	18.5	18.2	17.8	17.2	16.2	15	13.5					
F4-32/250B	1.5	2		21.5	21.2	20.8	20.2	19.5	18.2	17	15.5				
F4-32/250A	2.2	3		24	23.7	23.3	22.7	22	21	19.8	18.3	16.5			

Q = Débit H = Hauteur manométrique totale HS = Hauteur d'aspiration

Tolérance des courbes de prestation selon EN ISO 9906 Degré 3B.

F4-40/160

COURBES ET CARACTÉRISTIQUES DE PERFORMANCE

50 Hz n= 1450 rpm HS= 0 m

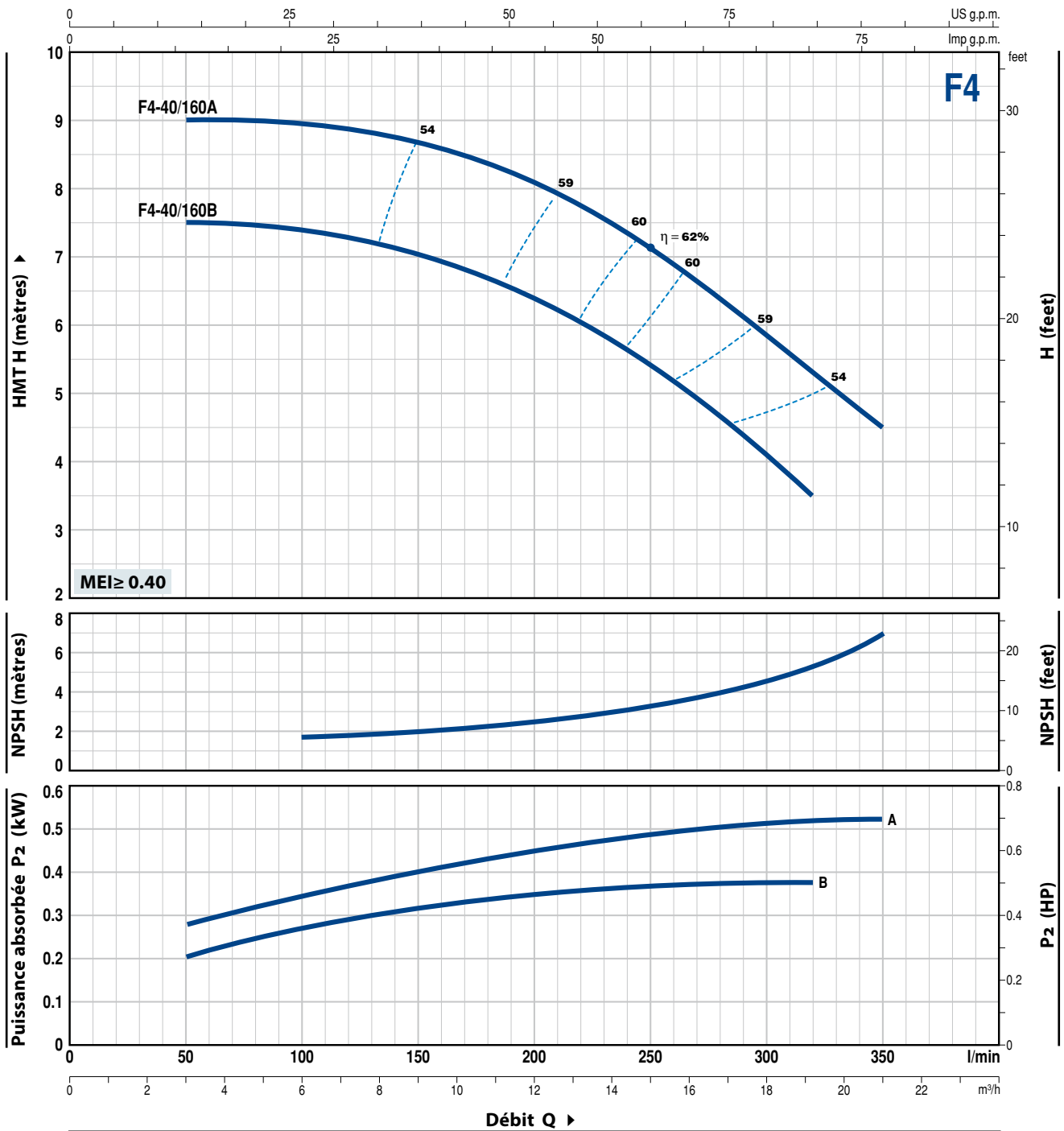

TYPE	PUISSANCE (P ₂)		Q	H								
	kW	HP		m ³ /h	3	6	9	12	15	18	19.2	21
Triphasé			l/min	50	100	150	200	250	300	320	350	
F4-40/160B	0.37	0.5	H mètres	7.5	7.4	7	6.4	5.4	4.1	3.5		
F4-40/160A	0.55	0.75		9	8.9	8.7	8.1	7.1	5.8	5.3	4.5	

Q = Débit H = Hauteur manométrique totale HS = Hauteur d'aspiration

Tolérance des courbes de prestation selon EN ISO 9906 Degré 3B.

COURBES ET CARACTÉRISTIQUES DE PERFORMANCE

50 Hz n= 1450 rpm HS= 0 m

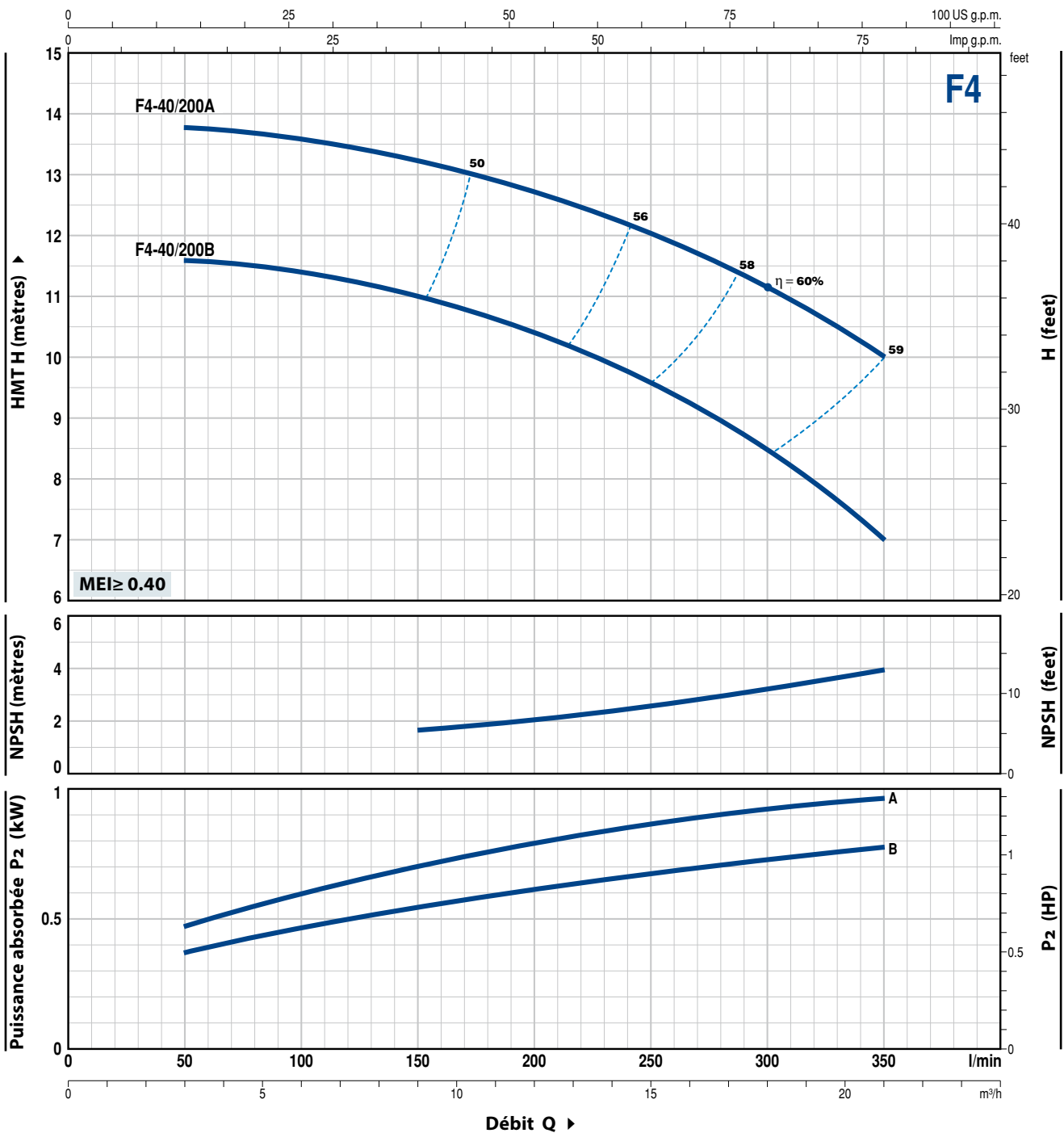

TYPE	PUISSANCE (P ₂)		Q	H							
	kW	HP		m ³ /h	3	6	9	12	15	18	21
Triphasé			l/min	50	100	150	200	250	300	350	
F4-40/200B	0.75	1	H mètres	11.5	11.4	11	10.4	9.5	8.5	7	
F4-40/200A	1.1	1.5		13.8	13.6	13.2	12.7	12	11.1	10	

Q = Débit H = Hauteur manométrique totale HS = Hauteur d'aspiration

Tolérance des courbes de prestation selon EN ISO 9906 Degré 3B.

F4-40/250

COURBES ET CARACTÉRISTIQUES DE PERFORMANCE

50 Hz n= 1450 rpm HS= 0 m

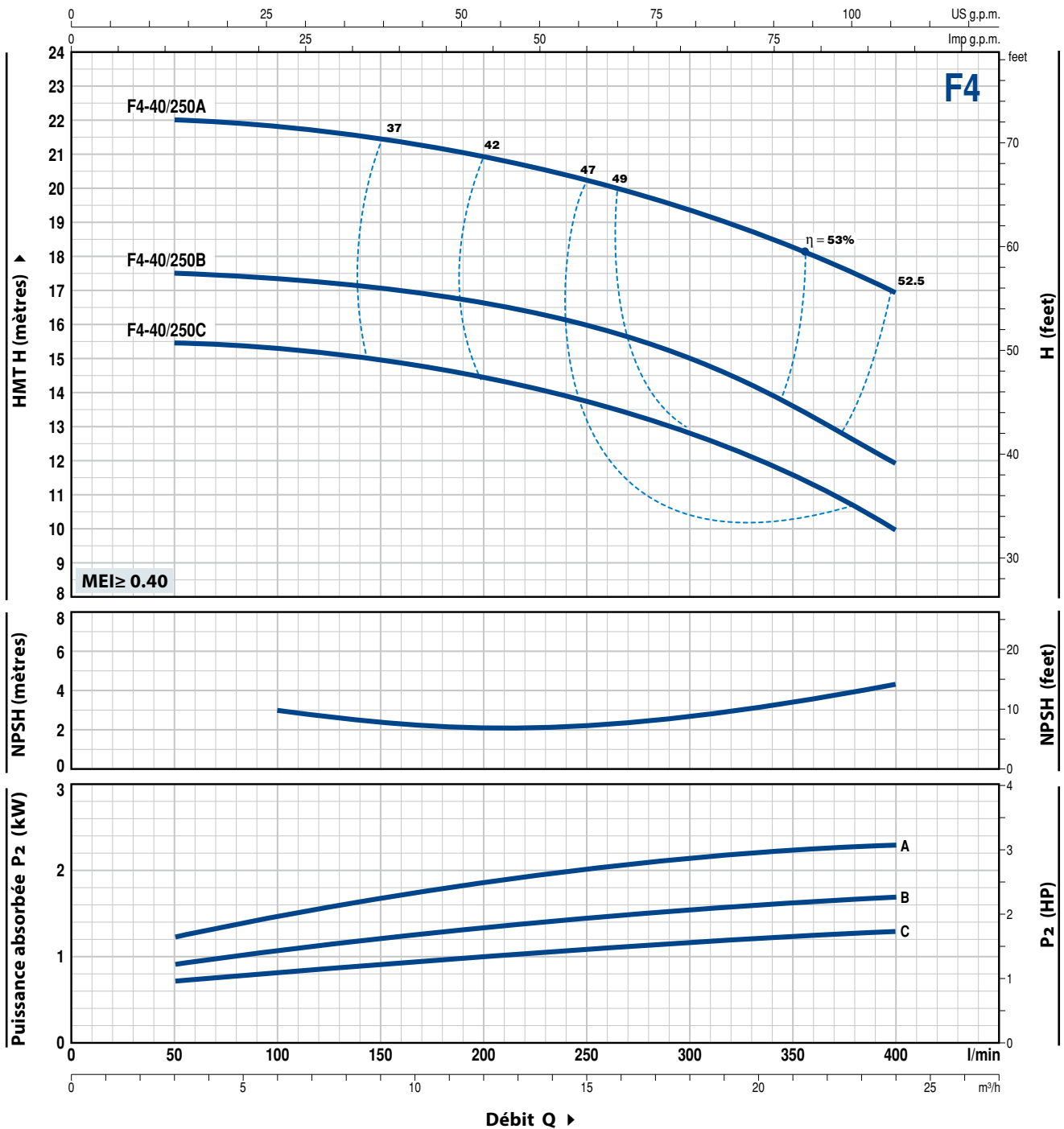

TYPE	PUISSANCE (P ₂)		Q	Q										
	kW	HP		m ³ /h	3	6	9	12	15	18	21	24		
Triphasé			l/min	50	100	150	200	250	300	350	400			
F4-40/250C	1.1	1.5	H mètres	15.5	15.2	15	14.5	13.6	12.9	11.5	10			
F4-40/250B	1.5	2		17.5	17.2	17	16.5	16	15	13.5	12			
F4-40/250A	2.2	3		22	21.9	21.5	21	20.2	19.2	18.2	17			

Q = Débit H = Hauteur manométrique totale HS = Hauteur d'aspiration

Tolérance des courbes de prestation selon EN ISO 9906 Degré 3B.

COURBES ET CARACTÉRISTIQUES DE PERFORMANCE

50 Hz n= 1450 rpm HS= 0 m

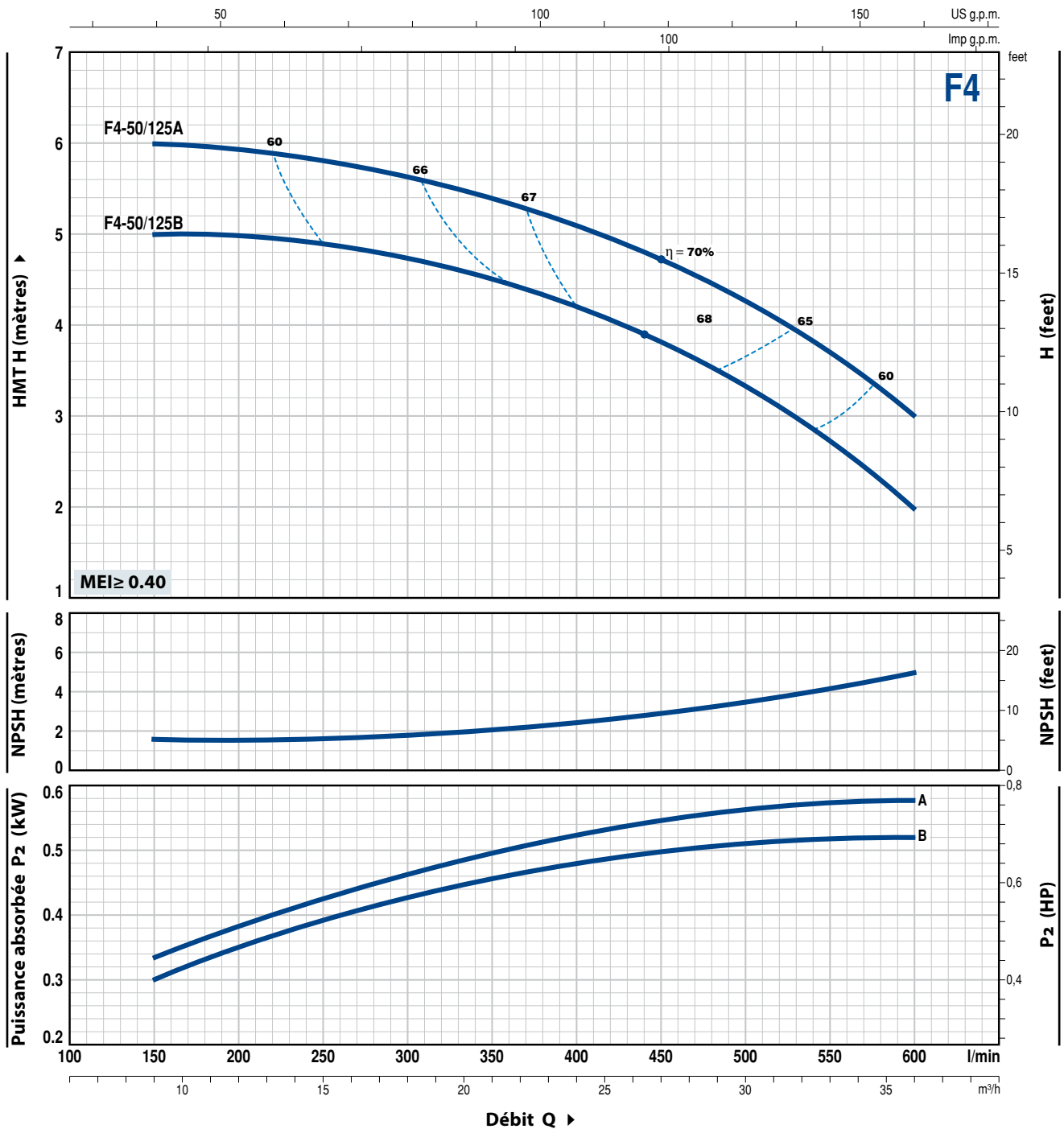

TYPE	PUISSANCE (P ₂)		Q	Flow Rate											
	kW	HP		m ³ /h	9	12	15	17	21	24	27	30	33	36	
Triphasé			l/min	150	200	250	300	350	400	450	500	550	600		
F4-50/125B	0.55	0.75	H mètres	5	5	4.9	4.7	4.5	4.2	3.8	3.3	2.7	2		
F4-50/125A	0.55	0.75		6	5.9	5.8	5.6	5.4	5.1	4.7	4.2	3.7	3		

Q = Débit H = Hauteur manométrique totale HS = Hauteur d'aspiration

Tolérance des courbes de prestation selon EN ISO 9906 Degré 3B.

F4-50/160

COURBES ET CARACTÉRISTIQUES DE PERFORMANCE

50 Hz n= 1450 rpm HS= 0 m

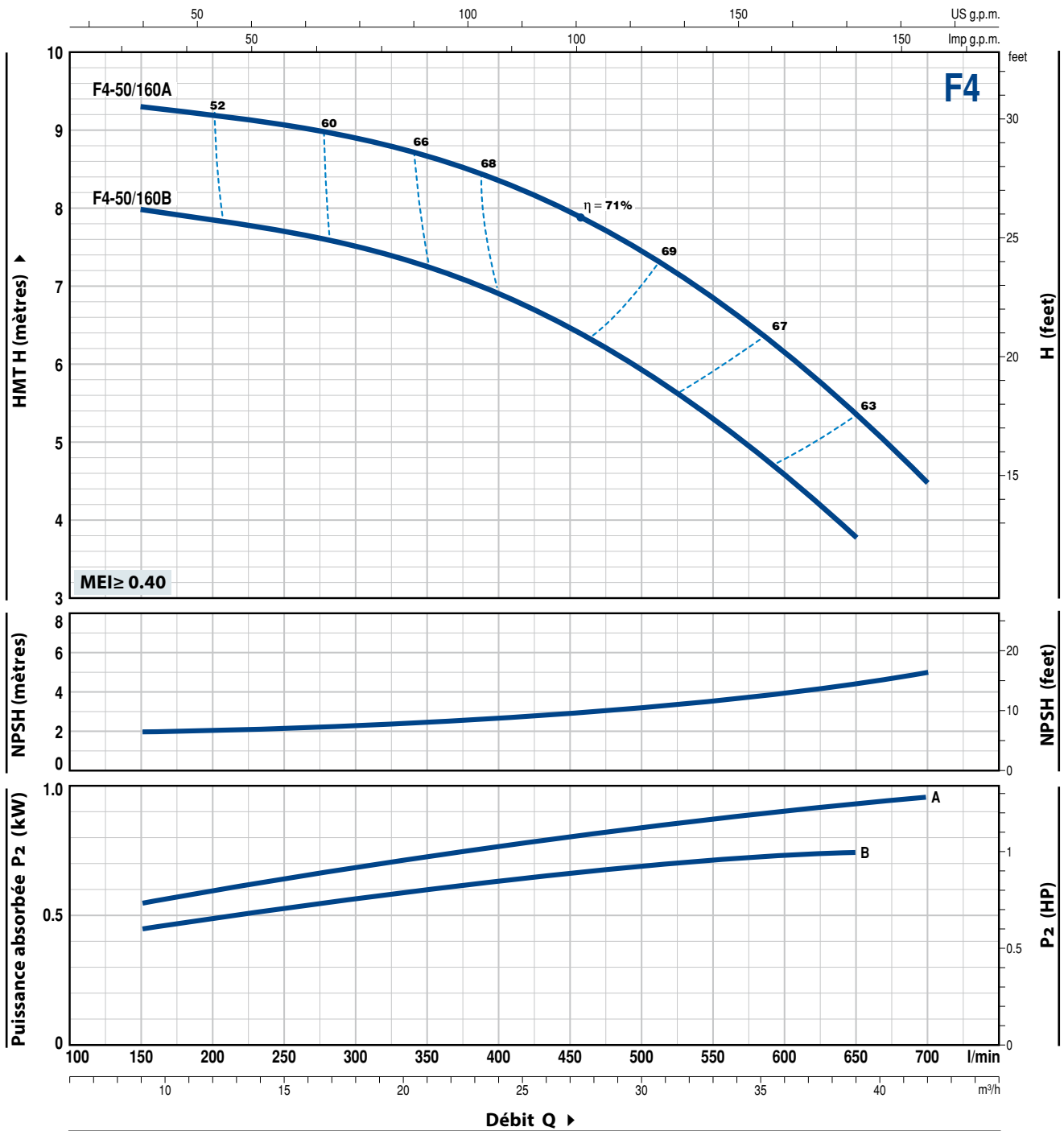

TYPE	PUISSANCE (P ₂)		Q	Flow Rate (m³/h)													
	kW	HP		9	12	15	17	21	24	27	30	33	36	39	42		
Triphasé			l/min	150	200	250	300	350	400	450	500	550	600	650	700		
F4-50/160B	0.75	1	H mètres	8	7.8	7.7	7.5	7.2	6.9	6.5	5.9	5.3	4.6	3.8			
F4-50/160A	1.1	1.5	H mètres	9.3	9.2	9.1	8.9	8.7	8.4	8	7.4	6.8	6.2	5.4	4.5		

Q = Débit H = Hauteur manométrique totale HS = Hauteur d'aspiration

Tolérance des courbes de prestation selon EN ISO 9906 Degré 3B.

COURBES ET CARACTÉRISTIQUES DE PERFORMANCE

50 Hz n= 1450 rpm HS= 0 m

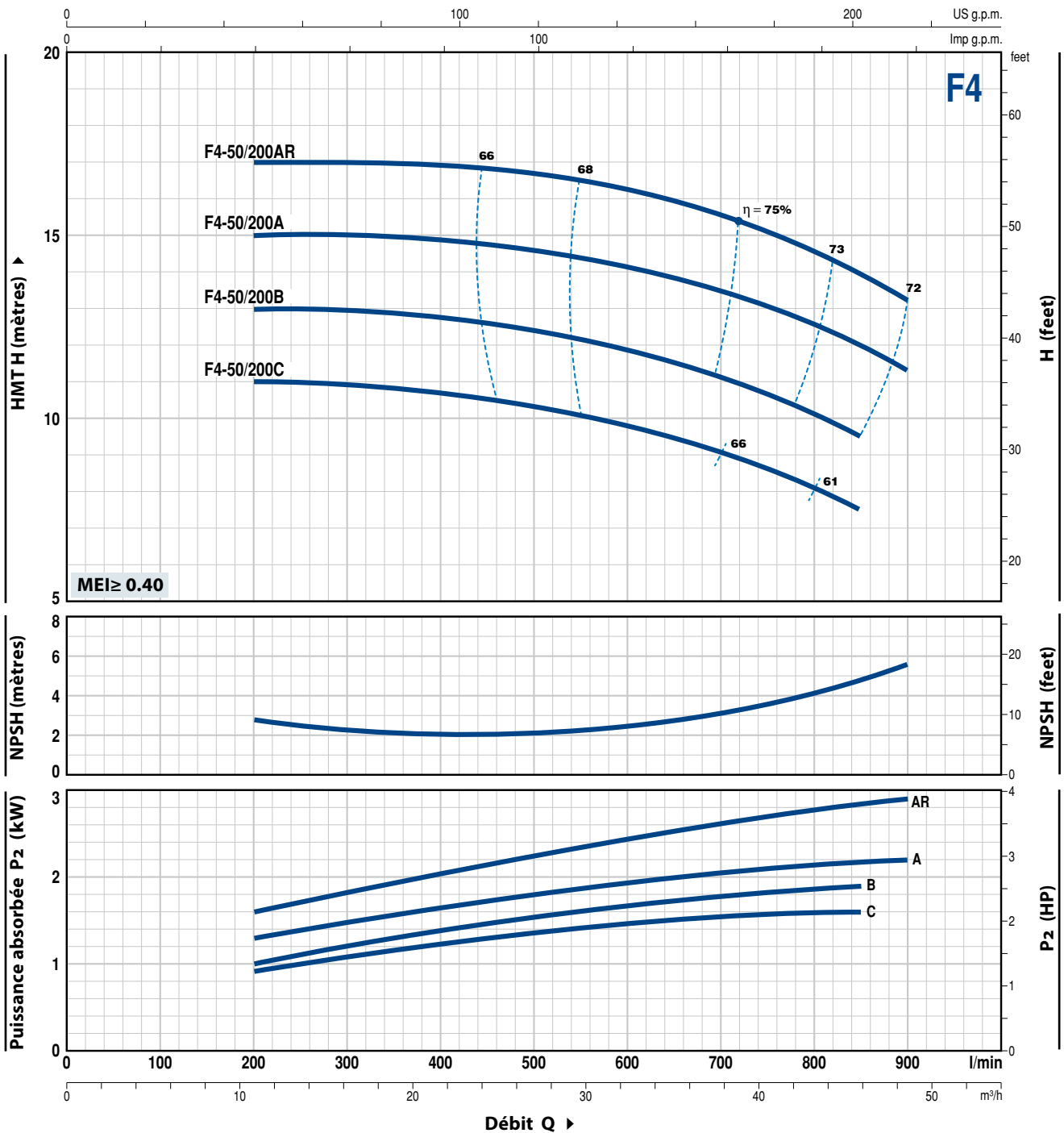

TYPE	PUISSANCE (P ₂)		Q	H											
	kW	HP		m ³ /h	12	17	24	30	36	42	48	51	54		
Triphasé			l/min	200	300	400	500	600	700	800	850	900			
F4-50/200C	1.5	2	H mètres	11	11	10.8	10.3	9.8	9	8	7.5				
F4-50/200B	2.2	3		13	13	12.8	12.4	11.9	11.1	10.1	9.5				
F4-50/200A	2.2	3		15	15	14.9	14.6	14.1	13.5	12.5	12	11.2			
F4-50/200AR	3	4		17	17	16.9	16.7	16.2	15.5	14.5	14	13.2			

Q = Débit H = Hauteur manométrique totale HS = Hauteur d'aspiration

Tolérance des courbes de prestation selon EN ISO 9906 Degré 3B.

F4-50/250

COURBES ET CARACTÉRISTIQUES DE PERFORMANCE

50 Hz n= 1450 rpm HS= 0 m

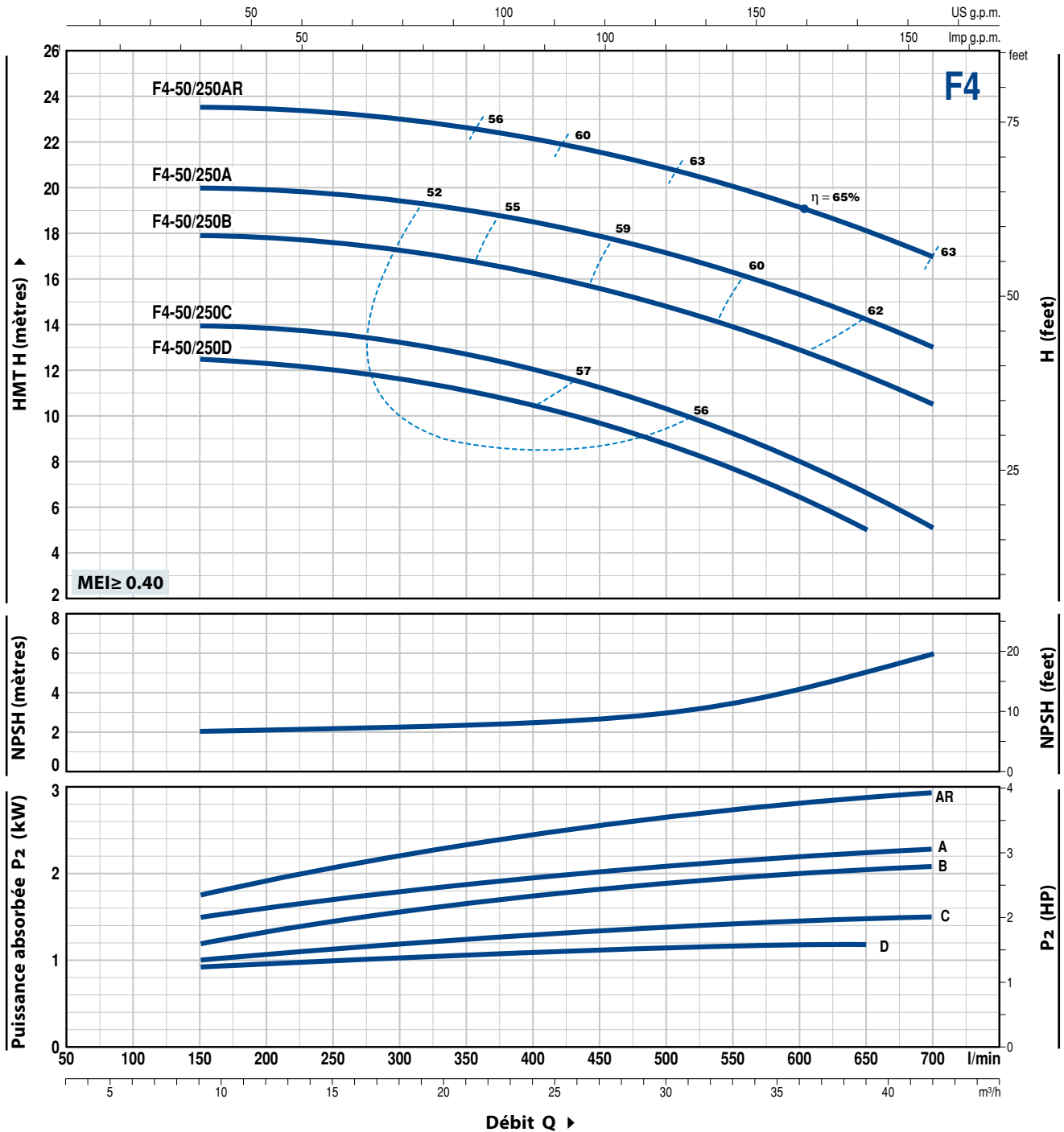

TYPE	PUISSANCE (P ₂)		Q	Débit													
	kW	HP		m ³ /h	9	12	15	18	21	24	27	30	33	36	39	42	
Triphasé			l/min	150	200	250	300	350	400	450	500	550	600	650	700		
F4-50/250D	1.1	1.5	H mètres	12.5	12.3	12	11.5	11.1	10.5	9.8	8.8	7.8	6.5	5			
F4-50/250C	1.5	2		14	13.9	13.6	13.2	12.8	12	11.2	10.2	9.2	8	6.6	5		
F4-50/250B	2.2	3		18	17.9	17.6	17.2	16.8	16.2	15.5	14.8	14	13	11.8	10.5		
F4-50/250A	2.2	3		20	19.9	19.7	19.5	19	18.5	18	17.2	16.2	15.3	14.2	13		
F4-50/250AR	3	4		23.5	23.4	23.2	23	22.6	22.1	21.6	21	20	19	18	17		

Q = Débit H = Hauteur manométrique totale HS = Hauteur d'aspiration

Tolérance des courbes de prestation selon EN ISO 9906 Degré 3B.

COURBES ET CARACTÉRISTIQUES DE PERFORMANCE

50 Hz n= 1450 rpm HS= 0 m

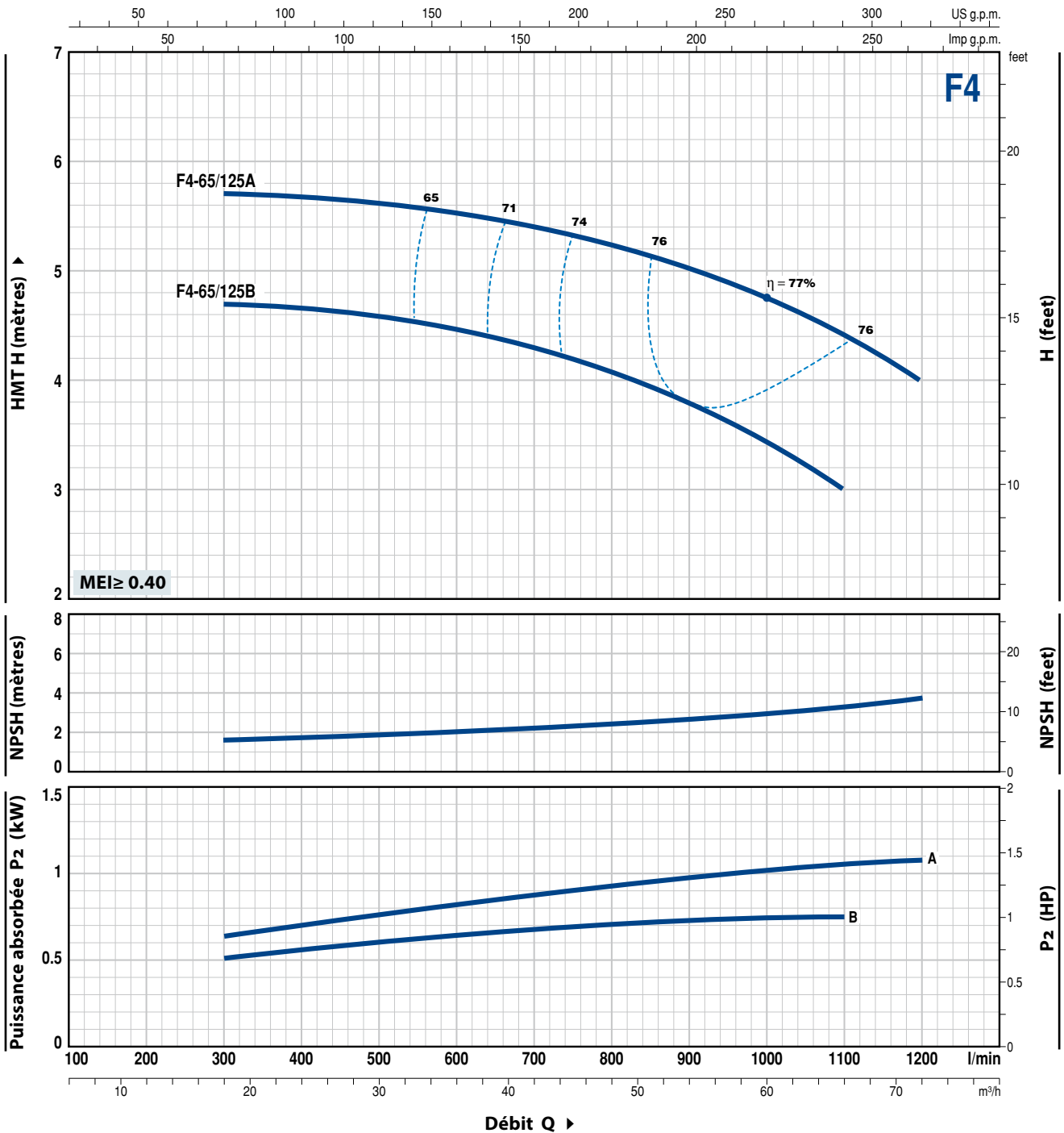

TYPE	PUISSANCE (P ₂)		Q	Flow Rate											
	kW	HP		m ³ /h	18	24	30	36	42	48	54	60	66	72	
Triphasé			l/min	300	400	500	600	700	800	900	1000	1100	1200		
F4-65/125B	0.75	1	H mètres	4.7	4.7	4.6	4.5	4.3	4.1	3.8	3.4	3			
F4-65/125A	1.1	1.5		5.7	5.7	5.6	5.5	5.4	5.2	5	4.7	4.4	4		

Q = Débit H = Hauteur manométrique totale HS = Hauteur d'aspiration

Tolérance des courbes de prestation selon EN ISO 9906 Degré 3B.

F4-65/160

COURBES ET CARACTÉRISTIQUES DE PERFORMANCE

50 Hz n= 1450 rpm HS= 0 m

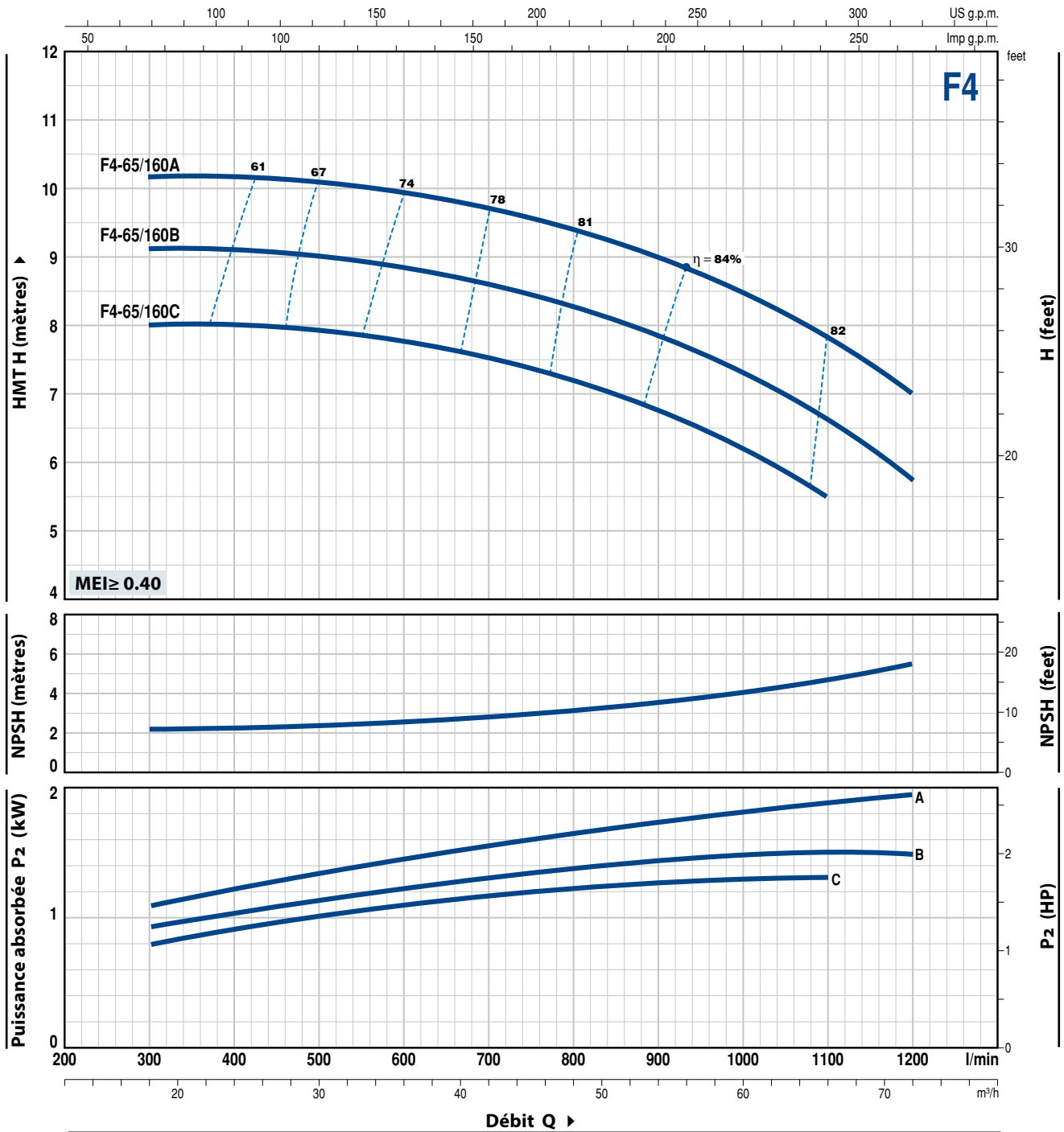

TYPE	PUISSANCE (P ₂)		Q	Débit											
	kW	HP		m ³ /h	18	24	30	36	42	48	54	60	66	72	
Triphasé			l/min	300	400	500	600	700	800	900	1000	1100	1200		
F4-65/160C	1.1	1.5	H mètres	8	8	7.9	7.7	7.5	7.2	6.7	6.2	5.5			
F4-65/160B	1.5	2		9.1	9.1	9	8.8	8.6	8.3	7.8	7.3	6.6	5.7		
F4-65/160A	2.2	3		10.1	10.1	10.1	9.9	9.7	9.4	9	8.5	7.8	7		

Q = Débit H = Hauteur manométrique totale HS = Hauteur d'aspiration

Tolérance des courbes de prestation selon EN ISO 9906 Degré 3B.

COURBES ET CARACTÉRISTIQUES DE PERFORMANCE

50 Hz n= 1450 rpm HS= 0 m

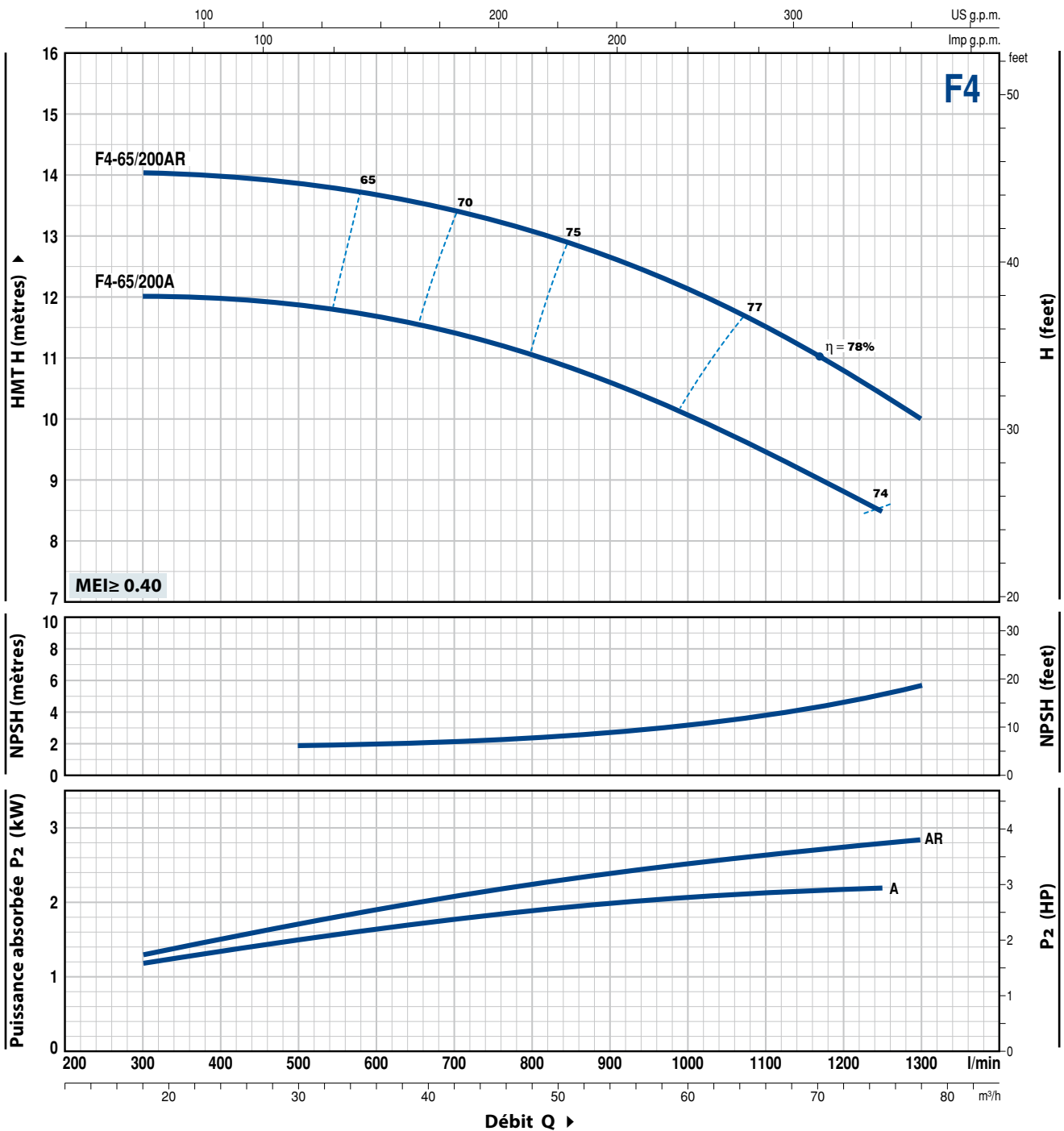

TYPE	PUISSANCE (P ₂)		Q	m ³ /h														
	kW	HP		18	24	30	36	42	48	54	60	66	72	75	78			
Triphasé			l/min	300	400	500	600	700	800	900	1000	1100	1200	1250	1300			
F4-65/200A	2.2	3	H mètres	12	12	11.9	11.6	11.4	11	10.6	10.1	9.5	8.8	8.5				
F4-65/200AR	3	4		14	13.9	13.8	13.6	13.4	13.1	12.7	12.1	11.5	10.8	10.3	10			

Q = Débit H = Hauteur manométrique totale HS = Hauteur d'aspiration

Tolérance des courbes de prestation selon EN ISO 9906 Degré 3B.

F4-65/250

COURBES ET CARACTÉRISTIQUES DE PERFORMANCE

50 Hz n= 1450 rpm HS= 0 m

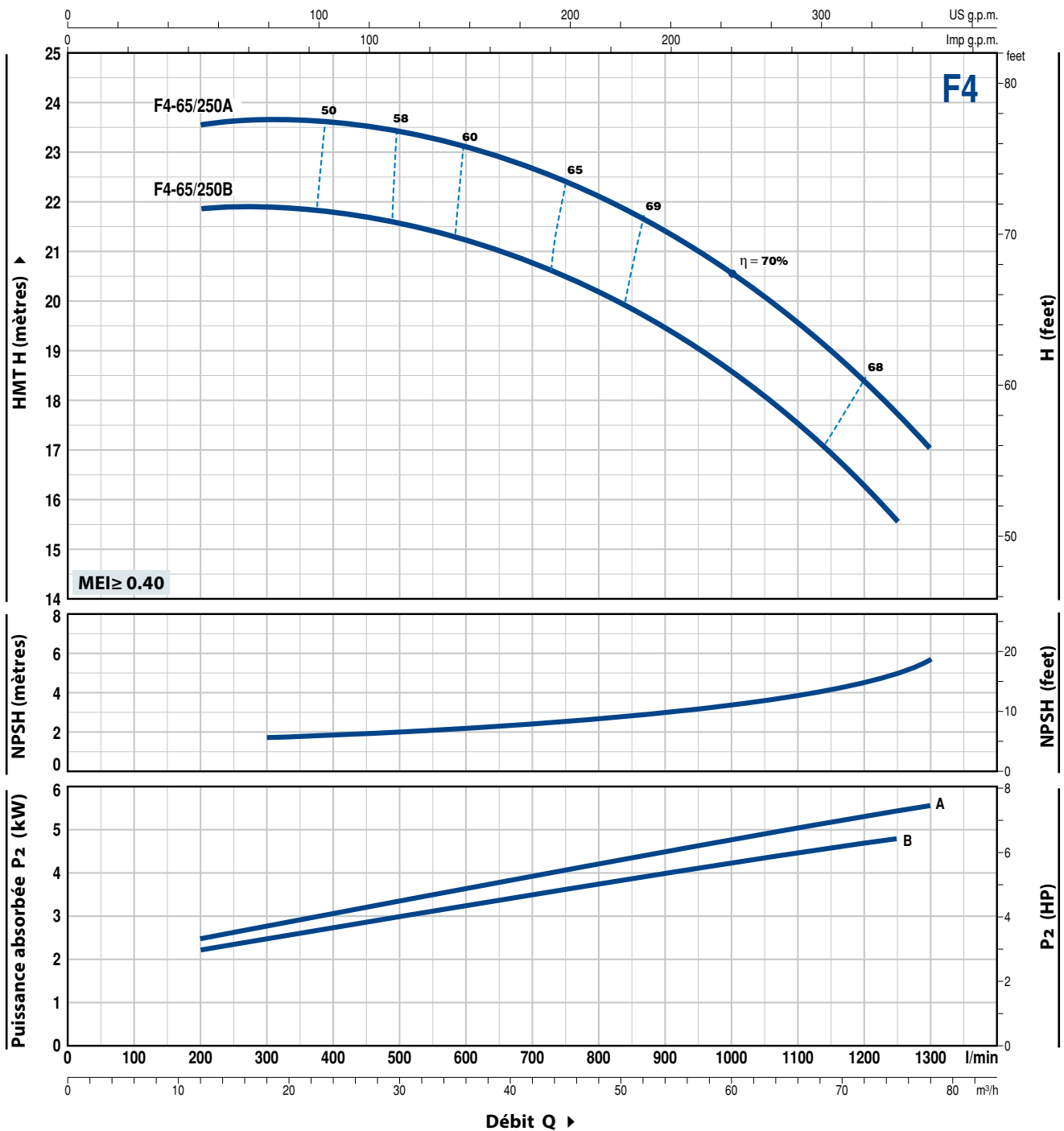

TYPE	PUISSANCE (P ₂)		Q	m ³ /h													
	kW	HP		12	18	24	30	36	42	48	54	60	66	72	75	78	
Triphasé			l/min	200	300	400	500	600	700	800	900	1000	1100	1200	1250	1300	
F4-65/250B	4	5.5	H mètres	21.8	21.8	21.7	21.5	21.2	20.7	20.2	19.5	18.6	17.5	16.2	15.5		
F4-65/250A	5.5	7.5		23.5	23.5	23.5	23.4	23.1	22.6	22.1	21.5	20.5	19.6	18.5	17.8	17	

Q = Débit H = Hauteur manométrique totale HS = Hauteur d'aspiration

Tolérance des courbes de prestation selon EN ISO 9906 Degré 3B.

COURBES ET CARACTÉRISTIQUES DE PERFORMANCE

50 Hz n= 1450 rpm HS= 0 m

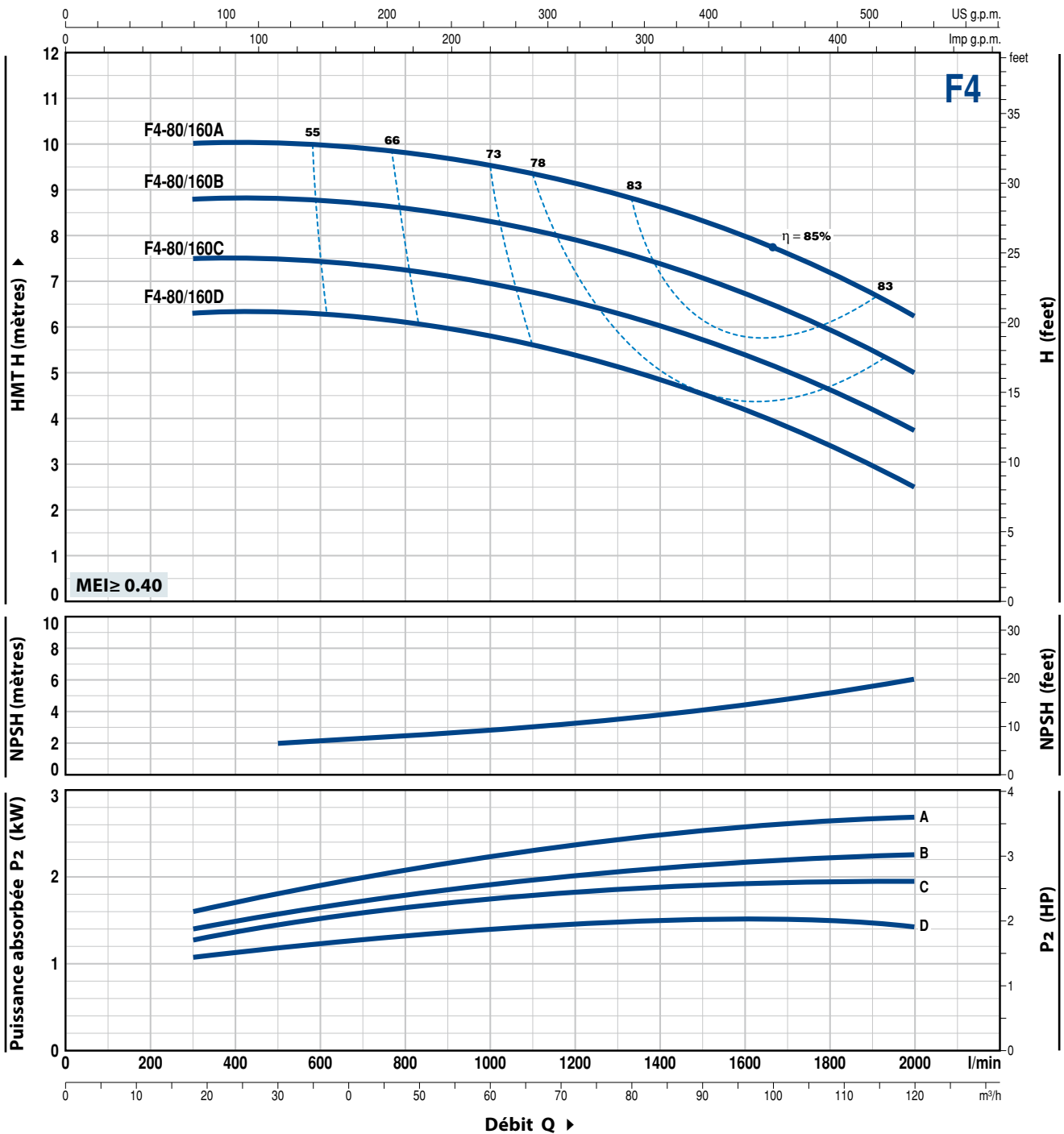

TYPE	PUISSANCE (P ₂)		Q	H											
	kW	HP		m ³ /h	18	24	36	48	60	72	84	96	108	120	
Triphasé			l/min	300	400	600	800	1000	1200	1400	1600	1800	2000		
F4-80/160D	1.5	2	H mètres	6.3	6.3	6.3	6.1	5.8	5.4	4.8	4.2	3.4	2.5		
F4-80/160C	2.2	3		7.5	7.5	7.4	7.3	6.9	6.5	6	5.4	4.6	3.8		
F4-80/160B	2.2	3		8.8	8.8	8.8	8.6	8.3	7.9	7.4	6.7	5.9	5		
F4-80/160A	3	4		10	10	10	9.8	9.5	9.1	8.6	8	7.2	6.2		

Q = Débit H = Hauteur manométrique totale HS = Hauteur d'aspiration

Tolérance des courbes de prestation selon EN ISO 9906 Degré 3B.

F4-80/200

COURBES ET CARACTÉRISTIQUES DE PERFORMANCE

50 Hz n= 1450 rpm HS= 0 m

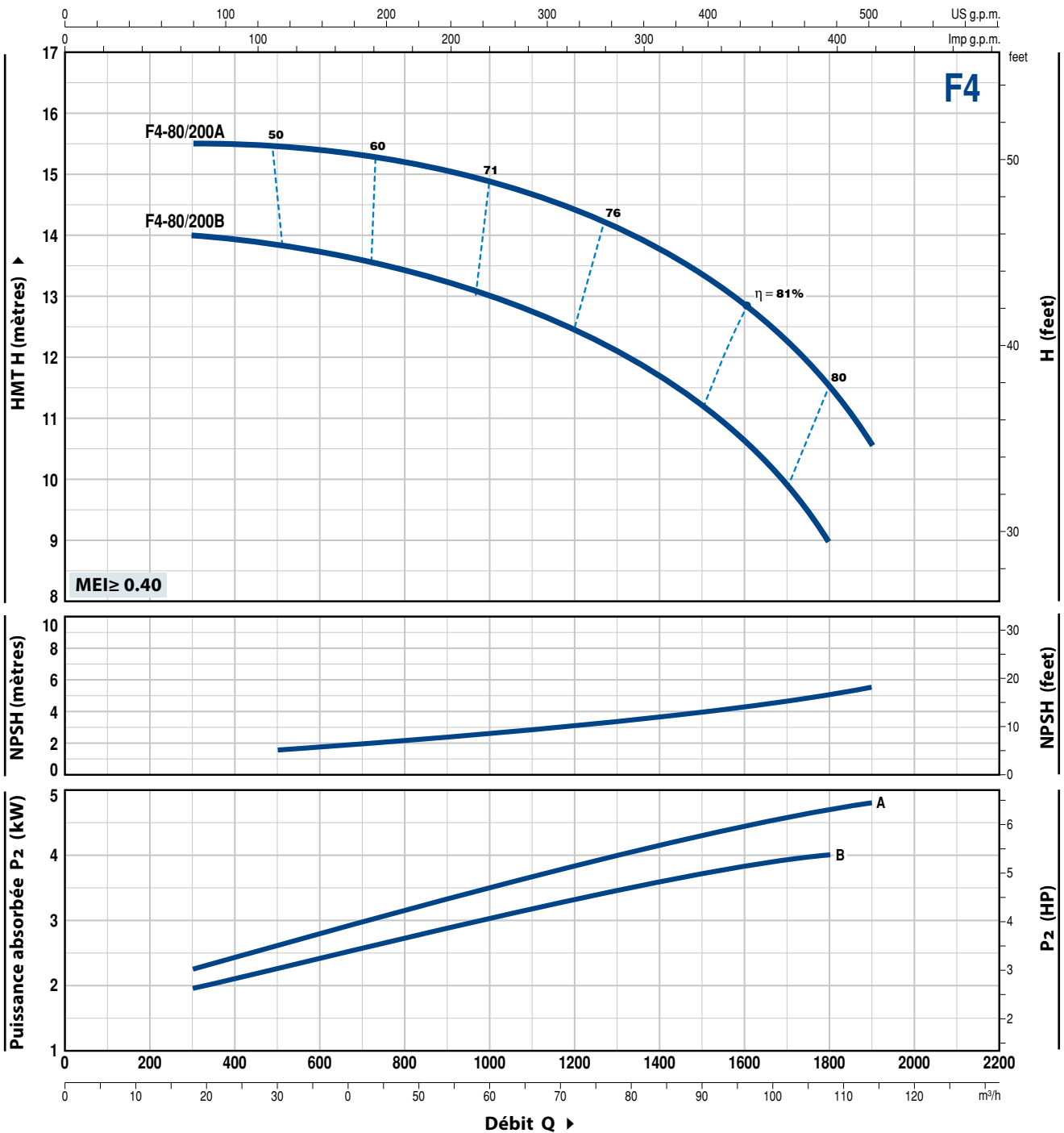

TYPE	PUISSANCE (P2)		Q	Flow Rate (m³/h)											
	kW	HP		18	24	36	48	60	72	84	96	108	114		
Triphasé			l/min	300	400	600	800	1000	1200	1400	1600	1800	1900		
F4-80/200B	4	5.5	H mètres	14	13.9	13.7	13.4	13	12.5	11.7	10.6	9			
F4-80/200A	5.5	7.5		15.5	15.5	15.4	15.2	14.8	14.5	13.7	12.8	11.5	10.5		

Q = Débit H = Hauteur manométrique totale HS = Hauteur d'aspiration

Tolérance des courbes de prestation selon EN ISO 9906 Degré 3B.

COURBES ET CARACTÉRISTIQUES DE PERFORMANCE

50 Hz n = 1450 rpm HS = 0 m

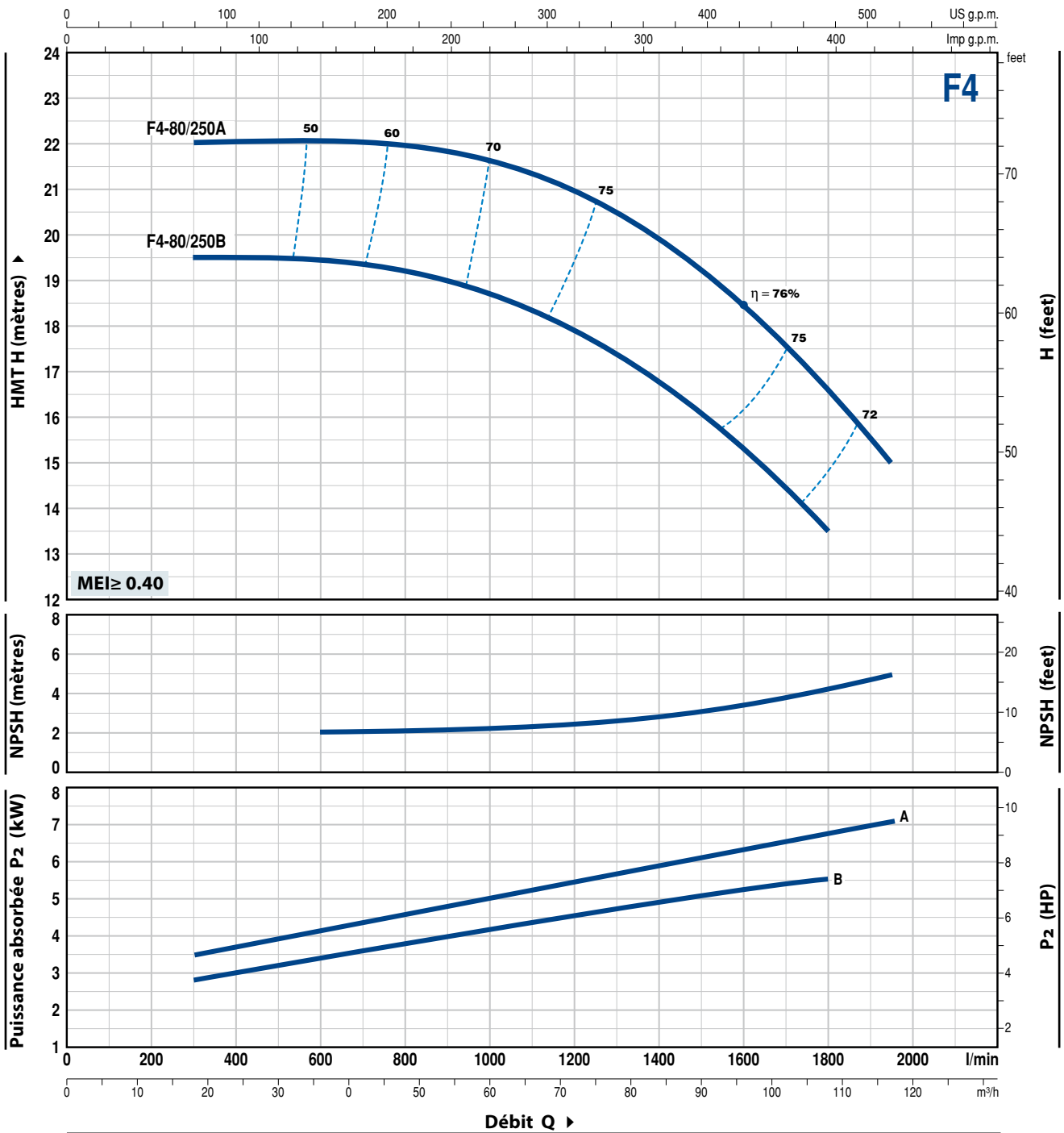

TYPE	PUISSANCE (P ₂)		Q	Flow Rate (Q)												
	kW	HP		m³/h	18	24	36	48	60	72	84	96	108	117		
Triphasé			l/min	300	400	600	800	1000	1200	1400	1600	1800	1950			
F4-80/250B	5.5	7.5	H mètres	19.5	19.5	19.5	19.2	18.7	17.9	16.7	15.3	13.5				
F4-80/250A	7.5	10		22	22	22	21.9	21.6	21	20	18.5	16.5	15			

Q = Débit H = Hauteur manométrique totale HS = Hauteur d'aspiration

Tolérance des courbes de prestation selon EN ISO 9906 Degré 3B.

F4-100/160

COURBES ET CARACTÉRISTIQUES DE PERFORMANCE

50 Hz n= 1450 rpm HS= 0 m

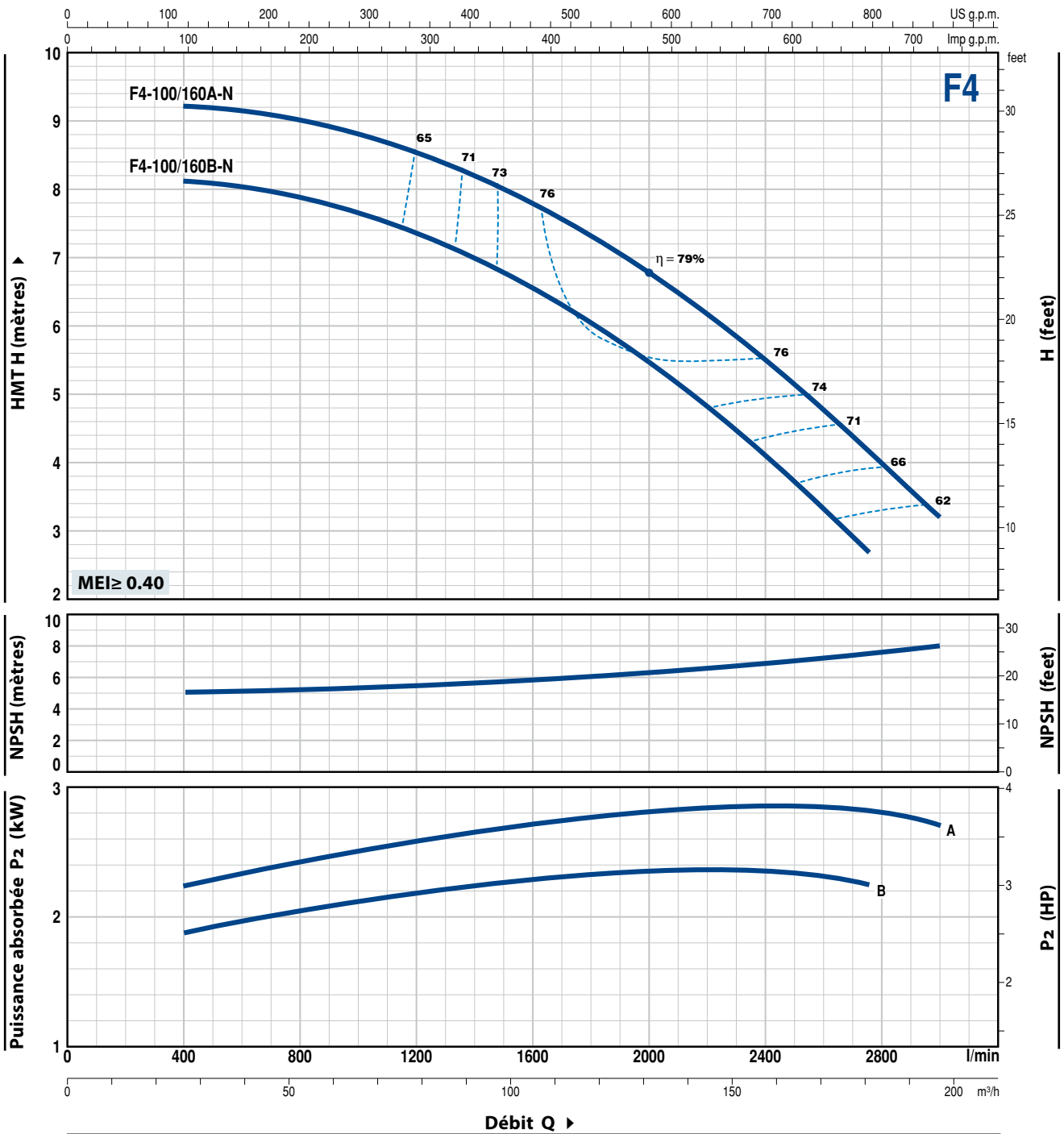

TYPE	PUISSANCE (P ₂)		Q	Débit									
	kW	HP		m ³ /h	24	48	72	96	120	144	165	180	
Triphasé			l/min	400	800	1200	1600	2000	2400	2750	3000		
F4-100/160B-N	2.2	3	H mètres	8.1	7.9	7.3	6.5	5.5	4.1	2.7			
F4-100/160A-N	3	4		9.2	9	8.5	7.8	6.8	5.5	4.2	3.2		

Q = Débit H = Hauteur manométrique totale HS = Hauteur d'aspiration

Tolérance des courbes de prestation selon EN ISO 9906 Degré 3B.

COURBES ET CARACTÉRISTIQUES DE PERFORMANCE

50 Hz n= 1450 rpm HS= 0 m

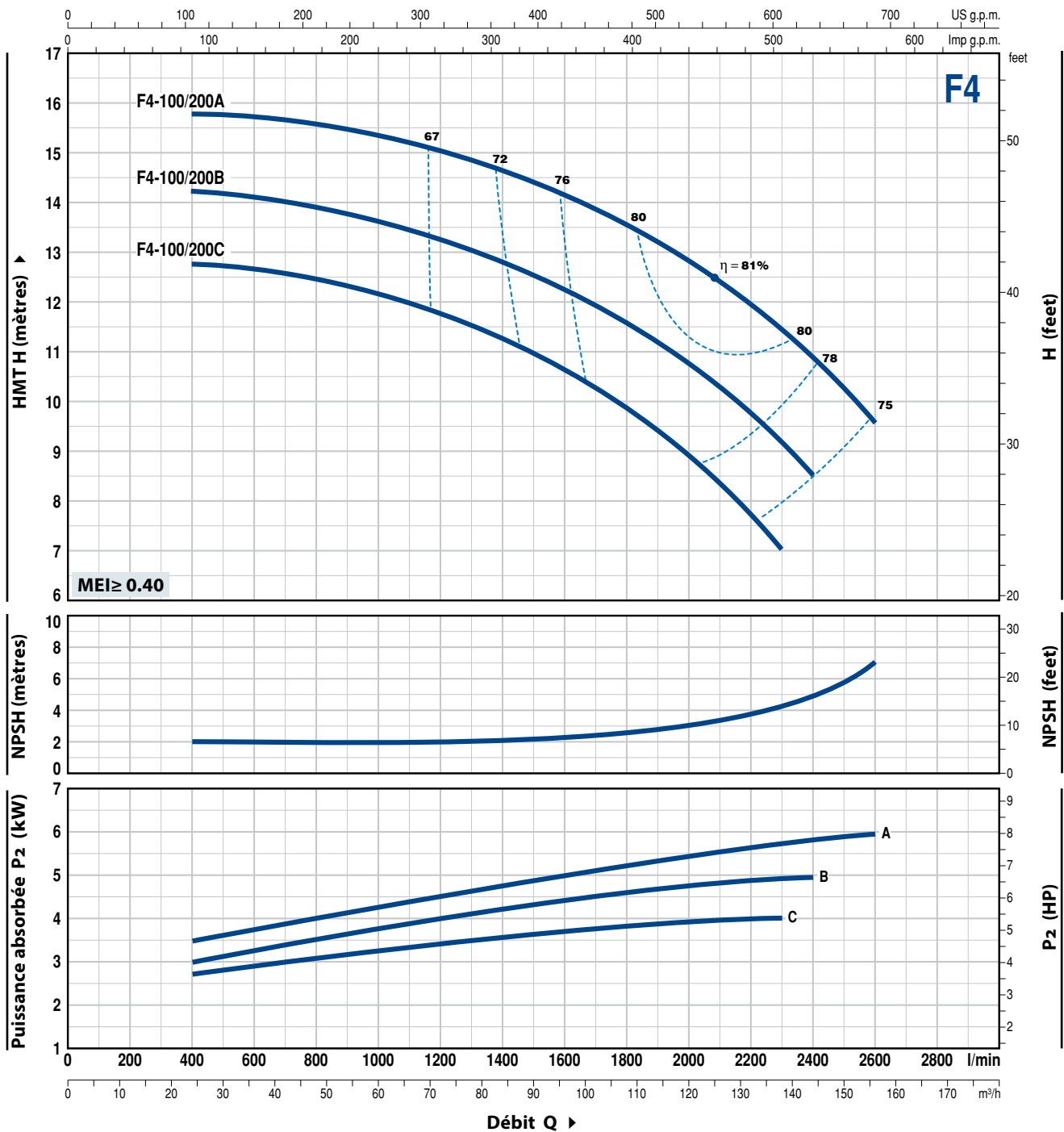

TYPE Triphasé	PUISSANCE (P ₂)		Q	Flow Rate (m³/h)														
	kW	HP		24	36	48	60	72	84	96	108	120	138	144	156			
			l/min	400	600	800	1000	1200	1400	1600	1800	2000	2300	2400	2600			
F4-100/200C	4	5.5	H mètres	12.7	12.6	12.5	12.2	11.8	11.3	10.6	9.9	8.9	7					
F4-100/200B	5.5	7.5		14.2	14.1	13.9	13.6	13.3	12.8	12.2	11.6	10.7	9.2	8.5				
F4-100/200A	5.5	7.5		15.8	15.7	15.6	15.4	15	14.6	14.2	13.5	12.8	12	11.4	9.5			

Q = Débit H = Hauteur manométrique totale HS = Hauteur d'aspiration

Tolérance des courbes de prestation selon EN ISO 9906 Degré 3B.

F4-100/250

COURBES ET CARACTÉRISTIQUES DE PERFORMANCE

50 Hz n= 1450 rpm HS= 0 m

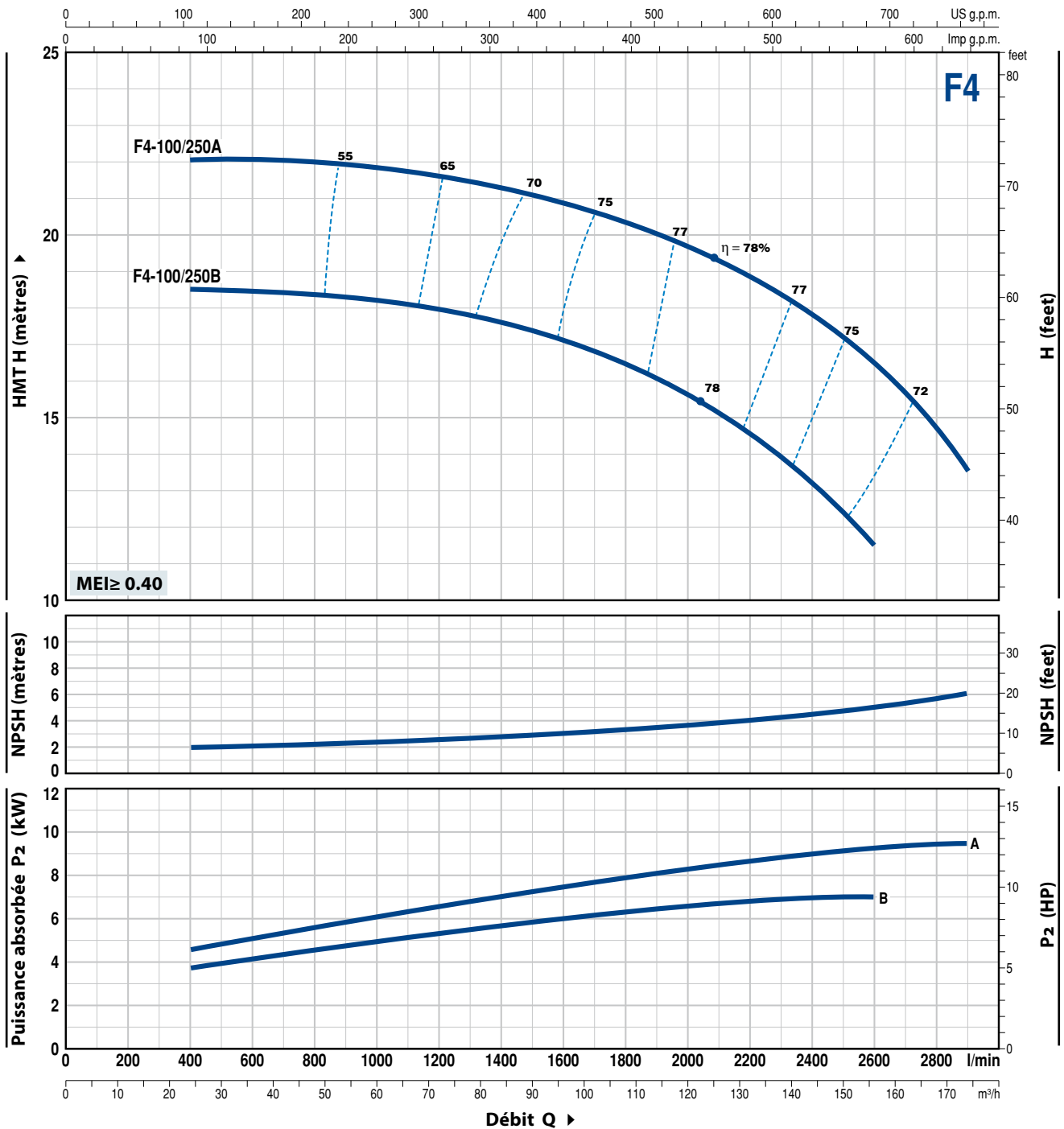

TYPE	PUISSANCE (P ₂)		Q	Flow Rates														
	kW	HP		m³/h	24	36	48	60	72	84	96	108	120	132	144	156	174	
Triphasé			l/min	400	600	800	1000	1200	1400	1600	1800	2000	2200	2400	2600	2900		
F4-100/250B	7.5	10	H mètres	18.5	18.5	18.3	18.2	18	17.5	17.1	16.5	15.7	14.5	13.2	11.5			
F4-100/250A	9.2	12.5		22	22	22	21.8	21.6	21.2	20.9	20.3	19.7	18.9	17.9	16.5	13.5		

Q = Débit H = Hauteur manométrique totale HS = Hauteur d'aspiration

Tolérance des courbes de prestation selon EN ISO 9906 Degré 3B.

REP. COMPOSANT

CARACTÉRISTIQUES DE CONSTRUCTION

1 CORPS DE POMPE	Fonte, avec orifices d'aspiration et de refoulement à bride						
2 COUVERCLE	Fonte						
3 ROUE	Laiton pour F4-32/160, 32/200, 40/160, 40/200, 50/125, 50/160						
4 ARBRE MOTEUR	Acier inox EN 10088-3 - 1.4104						
5 GARNITURE MÉCANIQUE	Électropompe	Garniture	Arbre	Matériaux			
	<i>Type</i>	<i>Type</i>	<i>Diamètre</i>	<i>Bague fixe</i>	<i>Bague mobile</i>	<i>Élastomère</i>	
	F4-32/160 F4-40/160	F4-50/125	FN-20	Ø 20 mm	Graphite	Céramique	NBR
	F4-32/200 F4-40/200	F4-50/160 F4-65/125	FN-24	Ø 24 mm	Graphite	Céramique	NBR
	F4-50/200 F4-65/200	F4-80/160 F4-100/160	FN-32 NU	Ø 32 mm	Graphite	Céramique	NBR
	F4-32/250 F4-40/250	F4-50/250	FN-38	Ø 38 mm	Graphite	Céramique	NBR
	F4-65/250 F4-80/200	F4-100/200	FN-40 NU	Ø 40 mm	Graphite	Céramique	NBR
	F4-80/250 F4-100/250		FN-45 NU	Ø 45 mm	Graphite	Céramique	NBR
6 ROULEMENTS	Électropompe	Type		Électropompe	Type		
	F4-32/160 F4-40/160 F4-50/125	6206 ZZ-C3 / 6204 ZZ		F4-32/250 F4-40/250 F4-50/200 F4-50/250 F4-65/160 F4-65/200 F4-80/160 F4-100/160	6208 ZZ-C3 / 6206 ZZ-C3		
	F4-32/200 F4-40/200 F4-50/160 F4-65/125	6307 ZZ-C3 / 6206 ZZ-C3		F4-65/250 F4-80/200 F4-80/250 F4-100/200 F4-100/250	6310 ZZ-C3 / 6308 ZZ-C3		
7 MOTEUR ÉLECTRIQUE	F4: à 4 pôles 230/400 -50 Hz						
	<p>➡ Les électropompes sont équipées de moteurs à haut rendement en classe IE2 jusqu'à P₂=1.1 kW et en classe IE3 à partir de P₂=1.5 kW (IEC 60034-30)</p> <p>– Isolation: classe F</p> <p>– Protection: IP X5</p>						

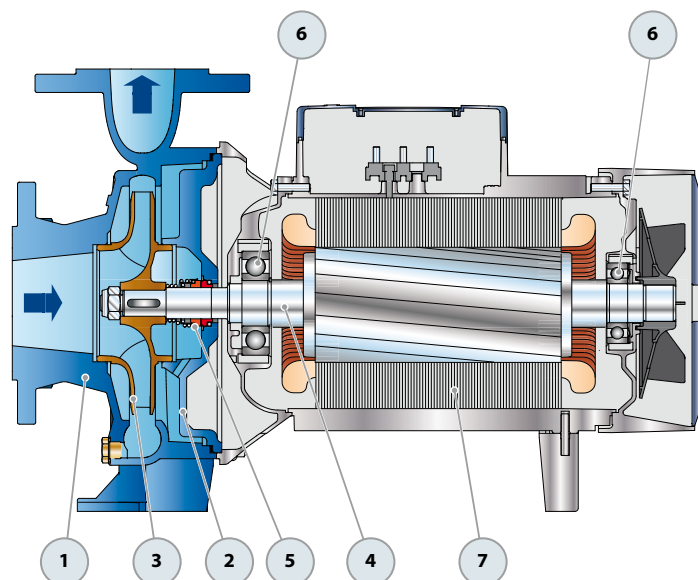

DIMENSIONS ET POIDS

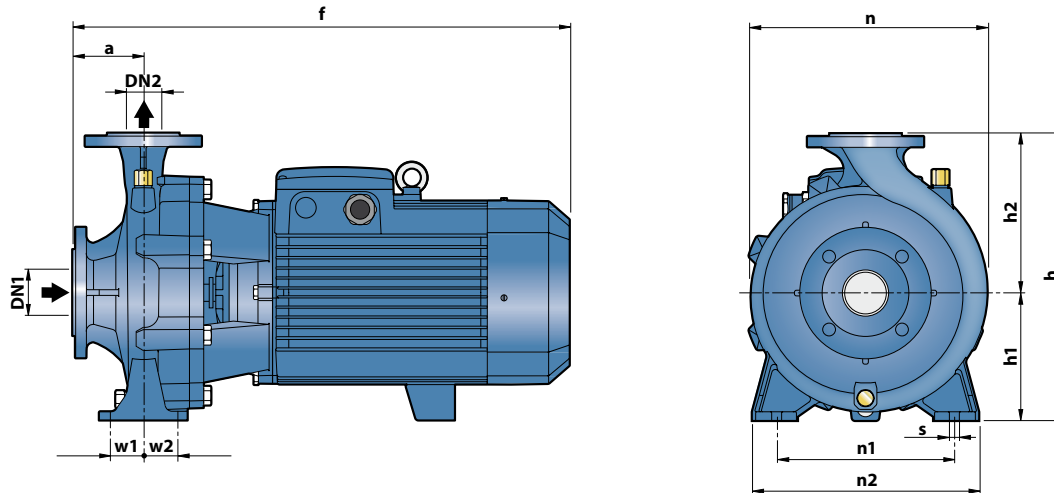

TYPE	DIMENSIONS mm													kg							
	DN1	DN2	a	f	h	h1	h2	n	n1	n2	w1	w2	s								
Triphasé																					
F4-32/160B	50	32	80	412	292	132	160	242	190	240	35	35	14	31.2							
F4-32/160A																			31.3		
F4-32/200B																				43.4	
F4-32/200A																				43.5	
F4-32/200BH					100	469	340	160	180	270	250	320		405	47.5	42.3					
F4-32/200AH																				42.4	
F4-32/250C							522	405	180	225						330					59.7
F4-32/250B							568														63.1
F4-32/250A													68.7								
F4-40/160B	65	40	80	412	292	132	160	240	190	240	35	35	14	32.5							
F4-40/160A																			32.9		
F4-40/200B					100	489	340	160	180	275	212	265		47.5	47.5	46.0					
F4-40/200A																				46.1	
F4-40/250C							522	405	180	225						328					59.7
F4-40/250B							568														63.1
F4-40/250A													68.7								
F4-50/125B	65	50	100	431	292	132	160	242	190	240	35	35	14	32.2							
F4-50/125A																				32.3	
F4-50/160B							489	340						160	180	269					44.4
F4-50/160A							529														44.5
F4-50/200C						576	360	160	200	316	212	265		47.5	47.5	64.4					
F4-50/200B																				64.7	
F4-50/200A						576	360	160	200	316						64.7					
F4-50/200AR																68.8					
F4-50/250D						522										59.9					
F4-50/250C																63.3					
F4-50/250B						568	405	180	225	337	250	320		47.5	47.5	68.7					
F4-50/250A																69.1					
F4-50/250AR																73.2					
F4-65/125B			80	65	100	511	340	160	180	291	212	280		47.5	47.5	14	51.0				
F4-65/125A																				51.1	
F4-65/160C							533	360	160	200	300						55.5				
F4-65/160B							579										58.7				
F4-65/160A																	63.7				
F4-65/200A							582	405	180	225	340	250	320				69.0				
F4-65/200AR																	73.0				
F4-65/250B							627	450	200	250	373	280	360	60	60		18	123.8			
F4-65/250A							722										139.6				
F4-80/160D	100	80				125	565					362	280	360	60		60	18	62.1		
F4-80/160C																					
F4-80/160B							611	405	180	225	330	250	320	47.5	47.5	14	67.5				
F4-80/160A																	71.4				
F4-80/200B							655	430	200	250	360	280	345				114.4				
F4-80/200A							750										130.2				
F4-80/250B							768	480	200	280	405	315	400	60	60	18	149.5				
F4-80/250A																	166.0				
F4-100/160B-N	125	100	125	622					391	280	360	60	60	18	70.7						
F4-100/160A-N																					
F4-100/200C							657	480	200	280								124.1			
F4-100/200B							752											139.8			
F4-100/200A																		140.1			
F4-100/250B							789	505	225	280	422	315	400					173.5			
F4-100/250A				821										182.9							

BRIDES DES ORIFICES

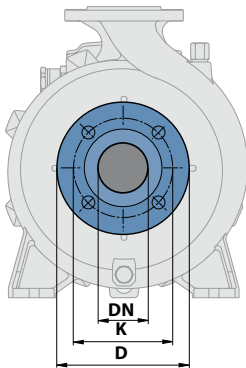

CONTRE-BRIDES

(A COMMANDER A PART)

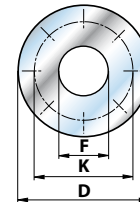

DN BRIDES mm	D mm	K mm	TROUS	
			N°	Ø (mm)
32	140	100	4	18
40	150	110		
50	165	125		
65	185	145		
80	200	160	8	
100	220	180		
125	250	210		

DN BRIDES mm	F CONTRE-BRIDES	D mm	K mm	TROUS	
				N°	Ø (mm)
32	1¼"	140	100	4	18
40	1½"	150	110		
50	2"	165	125		
65	2½"	185	145		
80	3"	200	160	8	
100	4"	220	180		
125	5"	250	210		

INTENSITES

TYPE	TENSION	
	230÷240 V	400÷415 V
Triphasé		
F4-32/160B	1.9 A	1.1 A
F4-32/160A	2.3 A	1.3 A
F4-32/200B	3.6 A	2.1 A
F4-32/200A	4.0 A	2.3 A
F4-32/200BH	3.1 A	1.8 A
F4-32/200AH	3.5 A	2.0 A
F4-32/250C	4.5 A	2.6 A
F4-32/250B	5.7 A	3.3 A
F4-32/250A	9.0 A	5.2 A
F4-40/160B	2.1 A	1.2 A
F4-40/160A	2.8 A	1.6 A
F4-40/200B	3.6 A	2.1 A
F4-40/200A	4.2 A	2.4 A
F4-40/250C	4.5 A	2.6 A
F4-40/250B	6.1 A	3.5 A
F4-40/250A	9.0 A	5.2 A
F4-50/125B	2.4 A	1.4 A
F4-50/125A	2.6 A	1.5 A
F4-50/160B	3.6 A	2.1 A
F4-50/160A	4.2 A	2.4 A
F4-50/200C	6.1 A	3.5 A
F4-50/200B	8.0 A	4.6 A
F4-50/200A	9.0 A	5.2 A
F4-50/200AR	11.8 A	6.8 A
F4-50/250D	4.5 A	2.6 A
F4-50/250C	5.9 A	3.4 A
F4-50/250B	8.5 A	4.9 A
F4-50/250A	9.9 A	5.7 A
F4-50/250AR	11.8 A	6.8 A

TYPE	TENSION	
	230÷240 V	400÷415 V
Triphasé		
F4-65/125B	3.6 A	2.1 A
F4-65/125A	4.5 A	2.6 A
F4-65/160C	4.7 A	2.7 A
F4-65/160B	5.9 A	3.4 A
F4-65/160A	7.8 A	4.5 A
F4-65/200A	9.0 A	5.2 A
F4-65/200AR	11.8 A	6.8 A
F4-65/250B	16.4 A	9.5 A
F4-65/250A	23.4 A	13.5 A
F4-80/160D	5.9 A	3.4 A
F4-80/160C	8.1 A	4.7 A
F4-80/160B	9.2 A	5.3 A
F4-80/160A	11.8 A	6.8 A
F4-80/200B	16.4 A	9.5 A
F4-80/200A	22.2 A	12.8 A
F4-80/250B	23.4 A	13.5 A
F4-80/250A	25.6 A	14.8 A
F4-100/160B-N	9.0 A	5.2 A
F4-100/160A-N	11.8 A	6.8 A
F4-100/200C	16.4 A	9.5 A
F4-100/200B	21.0 A	12.1 A
F4-100/200A	23.4 A	13.5 A
F4-100/250B	27.5 A	15.9 A
F4-100/250A	34.1 A	19.7 A