

QM, QT

Control panels

motralec

4 rue Lavoisier . ZA Lavoisier . 95223 HERBLAY CEDEX
Tel. : 01.39.97.65.10 / Fax. : 01.39.97.68.48
Demande de prix / e-mail : service-commercial@motralec.com
www.motralec.com



 **calpeda**[®]

50

TYPE	Supply		No. pumps				Application		
	1 ~	3 ~	1	2	3	4	Bore-hole	Submersible	Surface
QM	✓		✓				✓	✓	✓
M COMP	✓		✓				✓	✓	
PFC-M	✓		✓				✓		
QML 1 FT	✓		✓				✓	✓	✓
T COMP		✓	✓				✓	✓	
PFC-T		✓	✓				✓		
QTL 1 FT		✓	✓				✓		✓
QTL 1 D FTE		✓	✓				✓		✓
QTL 1 ST FT		✓	✓				✓		✓
QTL 1 ST FTE		✓	✓				✓		✓
QTL 1 SS E		✓	✓				✓		✓
QTL 1 IS FTE		✓	✓				✓		
QML 2 D	✓			✓					✓
QTL 2 FT		✓		✓					✓
QTL 2 ST FT		✓		✓					✓
QML 3 FT	✓				✓				✓
QTL 3 FT		✓			✓				✓
QTL 3 ST FT		✓			✓				✓
QTL 4 D FT		✓				✓			✓
QTL 4 ST FT		✓				✓			✓
QML 1 VFT	✓		✓						✓
QTL 1 VFT		✓	✓						✓
QML 2 VFT	✓			✓			✓		✓
QTL 2 VFT		✓		✓			✓		✓
QML 1.1 VFT	✓			✓					✓
QTL 1.1 VFT				✓					✓
QML 3 VFT	✓				✓				✓
QTL 3 VFT		✓			✓				✓
QTL 1.2 VFT		✓			✓				✓
QTL 4 VFT		✓				✓			✓
QTL 1.3 VFT		✓				✓			✓
QTL 2 VFDE		✓		✓					✓
QTL 1.1 VFDE		✓		✓					✓
QTL 3 VFDE		✓			✓				✓
QTL 1.2 VFDE		✓			✓				✓
QTL 4 VFDE		✓				✓			✓
QTL 1.3 VFDE		✓				✓			✓
QMLD 1D	✓		✓					✓	
QTLD 1D		✓	✓					✓	
QTLD 1ST FT		✓	✓					✓	
QMLD 2D	✓			✓				✓	
QTLD 2D		✓		✓				✓	
QTLD 2ST FT		✓		✓				✓	
QTLD 3D FT-RL		✓			✓			✓	
QTLD 3 ST-RL		✓			✓			✓	

Power kW	Rotation speed		Starting				Typology	
	Fixed Speed	Variable speed	D.O.L.	Y/Δ	Soft start	Impedance stator	Electromechanical	Electronic
0,3 ÷ 1,5	✓		✓				✓	
0,37 ÷ 2,2	✓		✓				✓	
0,37 ÷ 2,2	✓		✓					✓
0,37 ÷ 2,2	✓		✓					✓
0,37 ÷ 7,5	✓		✓				✓	
0,37 ÷ 5,5	✓		✓					✓
0,37 ÷ 11	✓		✓					✓
4 ÷ 30	✓		✓				✓	
5,5 ÷ 45	✓			✓				✓
5,5 ÷ 110	✓			✓			✓	
7,5 ÷ 132	✓				✓			✓
5,5 ÷ 110	✓					✓	✓	
0,37 ÷ 1,5	✓		✓					✓
0,37 ÷ 5,5	✓		✓					✓
5,5 ÷ 45	✓			✓				✓
0,37 ÷ 2,2	✓		✓					✓
0,37 ÷ 5,5	✓		✓					✓
5,5 ÷ 4,5	✓							✓
0,37 ÷ 5,5	✓		✓					✓
5,5 ÷ 45	✓							✓
0,37 ÷ 3,7		✓	✓					✓
0,4 ÷ 7,5		✓	✓					✓
0,37 ÷ 3,7		✓						✓
0,4 ÷ 7,5		✓						✓
0,37 ÷ 3,7		✓						✓
0,4 ÷ 75		✓						✓
0,37 ÷ 3,7		✓						✓
0,4 ÷ 75		✓						✓
0,4 ÷ 75		✓						✓
0,4 ÷ 75		✓						✓
0,4 ÷ 75		✓						✓
0,75 ÷ 7,5		✓						✓
0,75 ÷ 7,5		✓						✓
0,75 ÷ 7,5		✓						✓
0,75 ÷ 7,5		✓						✓
0,75 ÷ 7,5		✓						✓
0,75 ÷ 7,5		✓						✓
0,25 ÷ 1,1	✓		✓					✓
0,25 ÷ 1,1	✓		✓					✓
4 ÷ 92	✓			✓				✓
0,25 ÷ 1,1	✓		✓					✓
0,25 ÷ 1,1	✓		✓					✓
4 ÷ 92	✓			✓				✓
0,55 ÷ 5,5	✓		✓					✓
4 ÷ 92	✓			✓				✓

Electric control boards

M COMP Control panel for 1 single-phase submersible pump



Type	Protector max A	Capacitor 450Vc	Motor 230V - 1~ kW	Dimensions HxBxP mm
M COMP 4-16	4,5	16 µF	0,37	230x215x115
M COMP 4-20	4,5	20 µF	0,55	230x215x115
M COMP 5-20	5	20 µF	0,55	230x215x115
M COMP 5-25	5	25 µF	0,55	230x215x115
M COMP 6-20	6	20 µF	0,75	230x215x115
M COMP 6-35	6	35 µF	0,9	230x215x115
M COMP 7-25	7	25 µF	0,9	230x215x115
M COMP 7-30	7	30 µF	0,9	230x215x115
M COMP 8-25	8	25 µF	1,1	230x215x115
M COMP 8-30	8	30 µF	1,1	230x215x115
M COMP 10-35	10	35 µF	1,1	230x215x115
M COMP 10-40	10	40 µF	1,1	230x215x115
M COMP 12-35	12	35 µF	1,5	230x215x115
M COMP 12-50	12	50 µF	1,5	230x215x115
M COMP 12-60	12	60 µF	1,5	230x215x115
M COMP 16-70	16	70 µF	2,2	230x215x115

Construction

Control panel with ON-OFF switch and capacitor for 1 submersible pump with single-phase motor. Suitable for use with LVBT board for level control.

Protection is provided by means of a main bipolar switch with a phase protected against overload by means of a thermal element.

PFC-M Control panel for 1 submersible pump with single-phase motor, PF control



Type	Setting A	Capacitor 450Vc	Motor 50/60Hz 220V-240V - 1~ kW	Dimensions HxBxP mm
PFC-M 18-16	1 - 18	16 µF	0,37	220x210x110
PFC-M 18-20	1 - 18	20 µF	0,55	220x210x110
PFC-M 18-25	1 - 18	25 µF	0,55	220x210x110
PFC-M 18-30	1 - 18	30 µF	0,75	220x210x110
PFC-M 18-35	1 - 18	35 µF	0,75	220x210x110
PFC-M 18-40	1 - 18	40 µF	1,1	220x210x110
PFC-M 18-50	1 - 18	50 µF	1,5	220x210x110
PFC-M 18-60	1 - 18	60 µF	1,5	220x210x110
PFC-M 18-70	1 - 18	70 µF	2,2	220x210x110

Construction

Control panel for controlling one submersible pump with single-phase motor. Electronic control of the operation and dry-running protection through the power factor (PF) control.

The installation of level probes into the well is not required.

It stops the pump in case of lack of air cushion in the pressure vessel (patented system).

Displayed operating data and alarms available in four languages.

QML 1 FT Control panel for 1 pump with single-phase motor, direct starting



Type	Motor 230V - 1~ kW	Setting A	Dimensions HxBxP mm
QML 1 FT 0,37	0,37	1,6 - 2,5	200x255x170
QML 1 FT 0,55	0,45 - 0,55	2,5 - 4	200x255x170
QML 1 FT 0,75	0,75	4 - 6,5	200x255x170
QML 1 FT 1,1	1,1	6,3 - 10	200x255x170
QML 1 FT 1,5	1,5	9 - 12	200x255x170

Construction

Control panel for 1 pump with single-phase motor, direct starting for pressure booster sets, with a patented working time-measuring system that stops the pump in case of lack of air cushion in the pressure vessel.

Arranged for the capacitor internal connection (for pumps without built-in capacitor) and for the SRL 3 level control card application against dry running.

Pump operation controlled by an electronic board type MP 1000 with microprocessor which allows three different modes of operation of the pump: standard, emergency and timed.

T COMP Control panel for 1 submersible pump with three-phase motor



Type	Protector A	Motor 230V - 3~ kW	Motor 400V - 3~ kW	Dimensions HxBxP mm
T COMP 8	1 ÷ 8	0,37 ÷ 1,5	0,5 ÷ 2,2	170x145x85
T COMP 10	7 ÷ 10	---	3 ÷ 3,7	230x180x155
T COMP 12	9 ÷ 12	2,2	4	230x180x155
T COMP 16	11 ÷ 16	3	5,5	230x180x155
T COMP 20	14 ÷ 20	3,7 - 4	7,5	230x180x155

Construction

Control panel and protection for 1 submersible pump with three-phase motor.

Arranged for the LVBT level control internal connection against dry running (T COMP8 model has the level control as a standard).

Control pumps with pressure switch and float-type switch.

Electric control boards

PFC-T Control panel for 1 submersible pump with three-phase motor, PF control

Type	Setting A	Motor		Dimensions HxBxP mm	kg
		400V 50Hz - 3~ kW	380V 60Hz - 3~ kW		
PFC-T 11	1 - 11	0,37 - 4	0,37 - 4	255x200x135	1,7
PFC-T 16	1 - 16	5,5	5,5	255x200x135	1,7



Construction

Control panel for controlling 1 submersible pump with three-phase motor. Electronic control of the operation and dry-running protection through the power factor (PF) control.

The installation of level probes into the well is not required.

It stops the pump in case of lack of air cushion in the pressure vessel (patented system) Displayed operating data and alarms, available in four languages.

QTL 1 FT Control panel for 1 pump with three-phase motor, direct starting

Type	Motor 400V - 3~ kW	Setting A	Dimensions HxBxP mm
QTL 1 FT 0,55	0,37 - 0,45 - 0,55	1 - 1,6	200x255x170
QTL 1 FT 1,1	0,75 - 1,1	1,6 - 2,5	200x255x170
QTL 1 FT 1,5	1,5	2,5 - 4	200x255x170
QTL 1 FT 3	2,2 - 3	4 - 6,5	200x255x170
QTL 1 FT 4	4	6,3 - 10	200x255x170
QTL 1 FT 5,5	5,5	9 - 12	200x255x170
QTL 1 D 7,5 FT	7,5	13 - 18	400x300x160
QTL 1 D 9,2 FT	9,2	17 - 23	400x300x160
QTL 1 D 11 FT	11	20 - 25	400x300x160



Construction

Control panel for 1 pump with three-phase motor, direct starting for pressure booster sets, with a patented working time-measuring system that stops the pump in case of lack of air cushion in the pressure vessel.

Pump operation controlled by an electronic card type MP 1000 with microprocessor which allows three different modes of operation of the pump: standard, emergency and timed.

Dry-running protection with float switch.

Arranged for SRL 3 level control application for probes connection against dry-running.

QTL 1 D FTE Control panel for 1 pump with three-phase motor, direct starting

Type	Motor 400V - 3~ kW	Setting A	Dimensions HxBxP mm
QTL 1 D 4 FTE	4	6,3 - 10	400x300x160
QTL 1 D 5,5 FTE	5,5	9 - 12	400x300x160
QTL 1 D 7,5 FTE	7,5	13 - 18	400x300x160
QTL 1 D 9,2 FTE	9,2	17 - 23	400x300x160
QTL 1 D 11 FTE	11	20 - 25	400x300x160
QTL 1 D 15 FTE	15	24 - 32	500x350x200
QTL 1 D 18,5 FTE	18,5	32 - 38	500x350x200
QTL 1 D 22 FTE	22	35 - 50	500x350x200
QTL 1 D 30 FTE	30	46 - 65	500x350x200



Construction

Electromechanical control panel for 1 pump with three-phase motor, direct starting.

Operating signals by E 1000 led card.

Dry-running protection with float switch.

Construction with SRLE level control for probes connection against dry-running on request .

QTL 1 ST FT Control panel for 1 pump with three-phase motor, Y/Δ starting

Type	Motor 400V - 3~		Dimensions HxBxP mm
	Power kW	Current A	
QTL 1 ST 5,5 FT	5,5	11 - 15	600x400x200
QTL 1 ST 7,5 FT	7,5	12 - 17	600x400x200
QTL 1 ST 11 FT	9,2 - 11	16 - 24	600x400x200
QTL 1 ST 15 FT	15	23 - 31	600x400x200
QTL 1 ST 18,5 FT	18,5	30 - 39	600x400x200
QTL 1 ST 22 FT	22	35 - 43	700x500x200
QTL 1 ST 30B FT	30	42 - 55	700x500x200
QTL 1 ST 30A FT	30	55 - 65	700x500x200
QTL 1 ST 37 FT	37	61 - 84	800x600x250
QTL 1 ST 45 FT	45	80 - 105	800x600x250



Construction

Control panel for 1 pump with three-phase motor, Y/Δ starting for pressure booster sets, with a patented working time-measuring system that stops the pump in case of lack of air cushion in the pressure vessel.

Pump operation controlled by an electronic card type MP 1000 with microprocessor with 3 different pump operating modes: standard, emergency and timed.

Dry-running protection with float switch.

Arranged for SRL 3 level control application for probes connection against dry-running on request.

Electric control boards

QTL 1 ST FTE Control panel for 1 pump with three-phase motor, Y/Δ starting



Type	Motor 400V - 3~		Dimensions HxBxP mm
	Power kW	Current A	
QTL 1 ST 5,5 FTE	5,5	11 - 15	500x350x200
QTL 1 ST 7,5 FTE	7,5	12 - 17	500x350x200
QTL 1 ST 11 FTE	9,2 - 11	16 - 24	500x350x200
QTL 1 ST 15 FTE	15	23 - 31	500x350x200
QTL 1 ST 18,5 FTE	18,5	30 - 39	500x350x200
QTL 1 ST 22 FTE	22	35 - 43	600x400x200
QTL 1 ST 30B FTE	30	42 - 55	600x400x200
QTL 1 ST 30A FTE	30	55 - 65	600x400x200
QTL 1 ST 37 FTE	37	61 - 84	700x500x200
QTL 1 ST 45 FTE	45	80 - 105	700x500x200
QTL 1 ST 55 FTE	55	100 - 125	700x500x200
QTL 1 ST 75 FTE	75	120 - 160	800x600x250
QTL 1 ST 92 FTE	92	140 - 198	800x600x250
QTL 1 ST 110 FTE	110	180 - 250	800x600x250

Construction

Electromechanical control panel for 1 pump with three-phase motor, Y/Δ starting.
 Operating signals by E 1000 led board.
 Dry-running protection with float switch.
 Construction with SRLE level control for probes connection against dry-running on request .

QTL 1 SS E Control panel for 1 pump with three-phase motor, start/stop with soft starter



Type	Motor 400V - 3~ kW	Max current output max A	Dimensions HxBxP mm
QTL 1 SS 9,2 E	9,2	22	700x500x250
QTL 1 SS 15 E	11 - 15	34	700x500x250
QTL 1 SS 22 E	18,5 - 22	48	700x500x250
QTL 1 SS 26 E	26	58	900x600x300
QTL 1 SS 30 E	30	68	900x600x300
QTL 1 SS 37 E	37	82	900x600x300
QTL 1 SS 45 E	45	92	900x600x300
QTL 1 SS 55 E	55	114	900x600x300
QTL 1 SS 63 E	63	126	1100x700x300
QTL 1 SS 75 E	75	150	1100x700x300
QTL 1 SS 92 E	92	196	1200x800x400
QTL 1 SS 110 E	110	231	1200x800x400
QTL 1 SS 132 E	132	245	1200x800x400

Construction

Control panel for 1 pump with three-phase motor, start/stop with soft starter.
 Operating signals on E 1000 led board.
 Application: control of submersible motor with great cable length and surface motors.
 Dry-running protection with float switch.
 Construction with SRLE level control for probes connection against dry-running on request .

QTL 1 IS FTE Control panel for 1 pump with three-phase motor, with Stator Impedance starter



Type	Motor 400V - 3~		Dimensions HxBxP mm
	Power kW	Current A	
QTL 1 IS 5,5 FTE-2RL	5,5	11 - 15	
QTL 1 IS 7,5 FTE-2RL	7,5	12 - 17	
QTL 1 IS 11 FTE-2RL	9,2 - 11	16 - 24	
QTL 1 IS 15 FTE-2RL	15	23 - 31	
QTL 1 IS 18,5 FTE-2RL	18,5	30 - 39	
QTL 1 IS 22 FTE-2RL	22	35 - 43	
QTL 1 IS 30 FTE-2RL	30	42 - 65	
QTL 1 IS 37 FTE-2RL	37	61 - 84	
QTL 1 IS 45 FTE-2RL	45	80 - 105	
QTL 1 IS 55 FTE-2RL	55	100 - 125	
QTL 1 IS 75 FTE-2RL	75	120 - 160	
QTL 1 IS 92 FTE-2RL	92	140 - 198	
QTL 1 IS 110 FTE-2RL	110	180 - 250	

Construction

Electromechanical control panel for 1 submersible pump with three-phase motor, with Stator Impedance starter.
 Operating signals on led board type E 1000.
 Application : submersible motors control with great cable length.
 Construction with SRLE level control for probes connection against dry-running .

Electric control boards

QML 1 VFT Control panel for 1 pump with variable speed three-phase motor

	Type	Motor 230V - 3~ kW	Max current output max A	Dimensions HxBxP mm
	QML 1 VFT 0,4	0,37 - 0,45	2,6	500x350x200
	QML 1 VFT 0,75	0,55 - 0,75	4	500x350x200
	QML 1 VFT 1,5	1,1 - 1,5	7,1	500x350x200
	QML 1 VFT 2,2	2,2	10	500x350x200
	QML 1 VFT 3,7	3,7	17,5	500x350x200

Construction

Single-phase mains supply control panel with frequency converter for 1 pump with three-phase variable speed motor, for constant pressure booster sets.

Arranged for SRL 3 level control application for probes connection against dry-running.

Pump operation controlled by an electronic board type MPS 4000 with microprocessor.

QTL 1 VFT Control panel for 1 pump with variable speed three-phase motor

	Type	Motor 400V - 3~ kW	Max current output max A	Dimensions HxBxP mm
	QTL 1 VFT 0,4	0,4	1,5	500x350x200
	QTL 1 VFT 0,75	0,55 - 0,75	2,5	500x350x200
	QTL 1 VFT 1,5	1,1 - 1,5	3,8	500x350x200
	QTL 1 VFT 2,2	2,2	5,5	500x350x200
	QTL 1 VFT 4	3 - 4	8,6	500x350x200
	QTL 1 VFT 5,5	5,5	13	600x400x200
	QTL 1 VFT 7,5	7,5	16	600x400x200
	QTL 1 VFT 11	9,2 - 11	22	700x500x200
	QTL 1 VFT 15	15	29	700x500x200
	QTL 1 VFT 22	18,5 - 22	43	800x600x250
	QTL 1 VFT 30	30	57	800x600x250
	QTL 1 VFT 37	37	70	1100x700x300
	QTL 1 VFT 45	45	85	1200x800x300
	QTL 1 VFT 55	55	105	1200x800x300
QTL 1 VFT 75	75	135	1200x800x300	

Construction

Control panel with frequency converter for 1 pump with three-phase variable speed motor, for constant pressure booster sets.

Arranged for SRL 3 level control application for probes connection against dry-running.

Pump operation controlled by an electronic board type MPS 4000 with microprocessor.

ELECTRONIC PROTECTION DEVICE FOR PUMP



Construction

Electronic device for pumps protection, the device stops the pump in case of dry running and motor overcurrent.

Electrical connection

- To pump motor cable (Schuko plug built-in)
- To electric line socket (Schuko plug built-in)

Applications

For protection of the pump:

- The device protect the pump:**
- against dry running;
 - against overcurrent.

Operating conditions

Maximum ambient temperature max 55 °C.

Single-phase mains voltage: 230 V ±10%.

Frequency: 50 - 60 Hz.

Protection IP 65.

Pump motor current Minimum 3 A - Maximum 8 A.

Control Panel

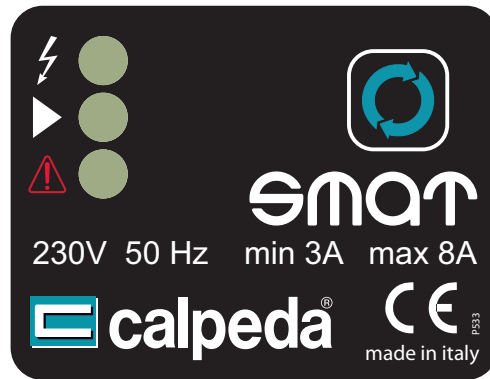

Operation



Green Led on = Device energised



Yellow Led on = Pump running



Blinking red Led = Water shortage
Red Led on = Power surge



RESTART button =
- Acquisition motor data
- Reset after fault

ELECTRONIC PROTECTION DEVICE FOR PUMP

Dimensions and weights

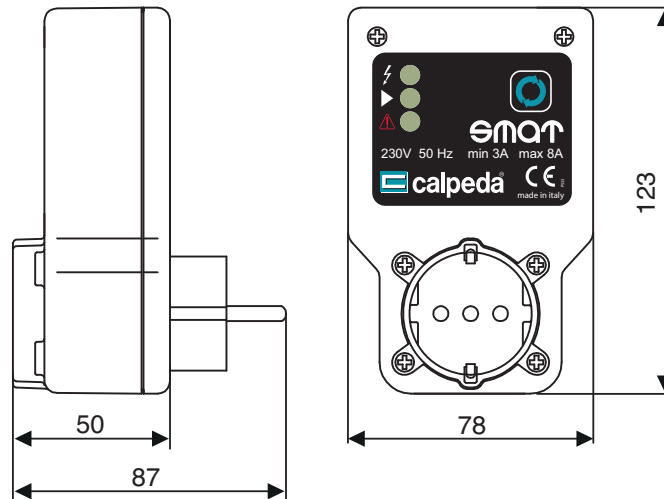

Example of installation

In order to operate, the electrical power supply of the pump must be connected to the mains.

For this reason the power supply plug of the pump must be inserted in the socket of the device which is in turn connected to the power point (see Figure).

In case of a water shortage on suction, the device will stop the pump and protect it against dry running.

This malfunctioning is indicated with the red "Failure" Led lit up.

In case of the current absorption exceeding 8 amperes, the device will stop the pump motor and protect it against over-current.

This malfunctioning is indicated with the red "Failure" Led lit up.

To restore normal operation to the device and the system simply press the red "Restart" button.

In case of a blackout, it will automatically rearm again several seconds after the electricity returns.

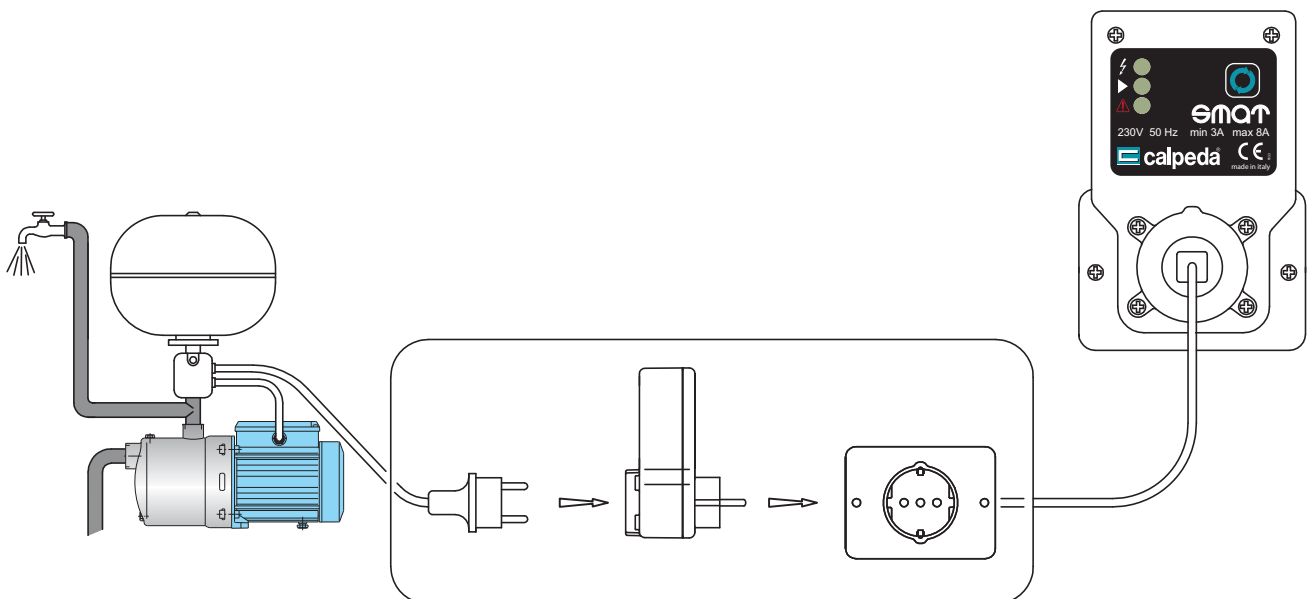

PRESSURE SWITCHES FOR WATER SYSTEM APPLICATIONS



Construction

- Pressure switches for use with water in autoclave systems
- The switch ensures automatically the starting and stopping of the electric pump according to the set pressure values
- Electric contacts: normally closed and made of brass alloy with Ag-Ni surfacing
- Terminals with M4 screws and 8x8 mm pressure dice
- NBR rubber membrane with textile insert (food grade for PMAT 5M-10, PMAT 5M/T-16, PMAT 5.5M/T-16)
- 1/4" hydraulic connection made of galvanized steel
- Standard protection degree IP 44
- Max ambient temperature: 55°C
- Tear resistant cable clamps

Adjustment key included

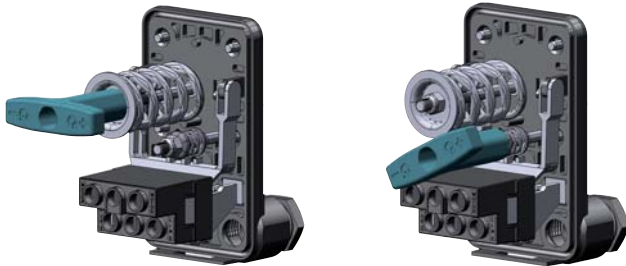

Technical data

2-pins	max A	Pressure range bar	Differential		Factory setting bar
			min bar	max bar	
PMAT 5M-10	10	1 - 5	0,6	2,3	1,4 - 2,8

Maximum rated voltage 250V

2-pins	max A	Pressure range bar	Differential		Factory setting bar
			min bar	max bar	
PMAT 5M/T-16	16	1 - 5	0,6	2,3	1,4 - 2,8
PMAT 5,5M/T-16	16	1,5 - 5,5	0,8	2,2	1,8 - 3
PMAT 12M/T-16	16	3 - 12	1,5	5	5 - 7

Maximum rated voltage 500V

Dimensions

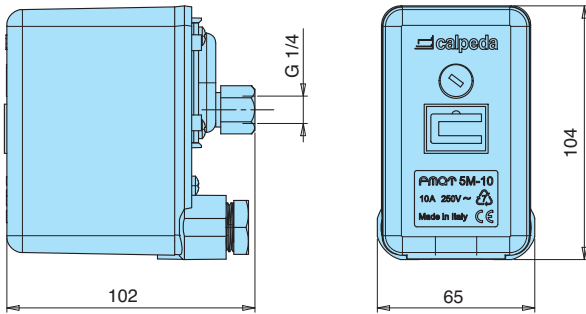

Connection diagram

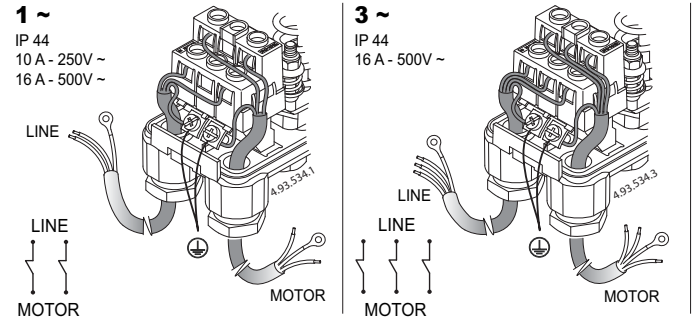
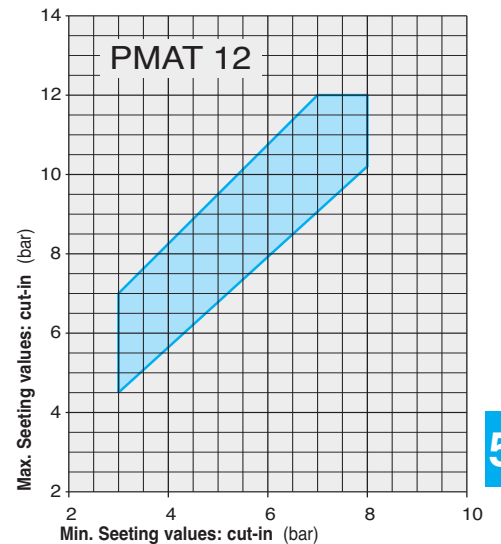
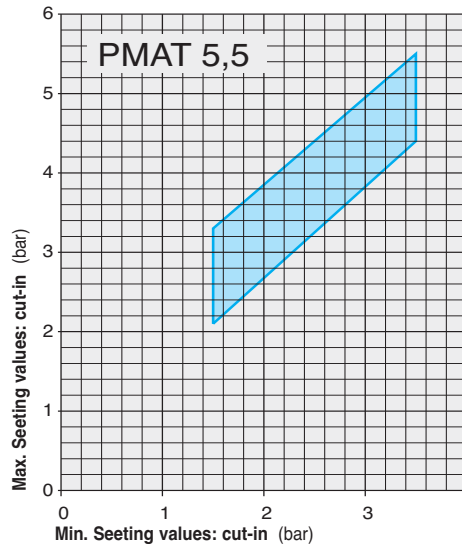
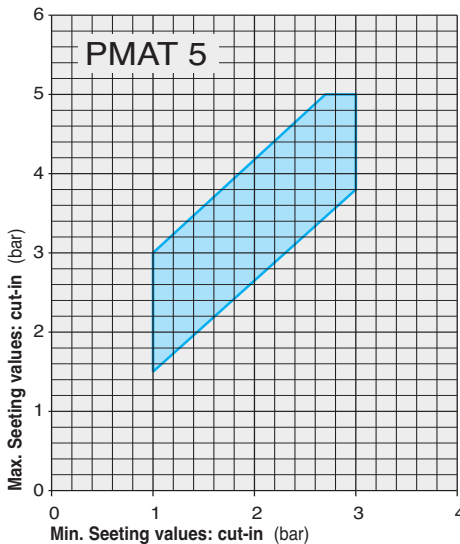

Diagram setting



ALIMENTATEUR D'AIR



ARIAMAT

type

AR 300E

AR 1000E

AR 2000E

Complete avec raccords et
1 m de tuyau en polyéthylène

Matériaux

Composant	Matériau
Raccord supérieur	Laiton
Valve	Laiton
Corps	Polycarbonate
Obturateur sphérique	Caoutchouc
Raccord conique	Laiton
Tube de liaison	Polyéthylène

Exécution

L'alimentateur d'air ARIAMAT régule automatiquement le matelas d'air dans les réservoirs galvanisés, en remplaçant l'air dissous dans l'eau à chaque démarrage de la pompe.

Cet appareil évite les nombreux démarrages de la pompe, permet une meilleure utilisation de la réserve d'eau dans les réservoirs galvanisés, améliore le rendement hydraulique de l'utilisation..

Fonctionnement

Le fonctionnement de l'alimentateur d'air ARIAMAT est illustré par les figures 1.2.3.4.

Le volume d'air injecté dans le ballon à chaque fin de cycle est respectivement de 300, 1000, 2000 cm³ pour les appareils AR 300E, AR 1000E et AR 2000E.

Pour un bon fonctionnement de l'ARIAMAT, il faut que la dépression à l'aspiration soit appropriée lorsque la pompe travaille.

Au cas où la pompe travaille avec hauteur de charge et l'eau arrive à la pompe par chute, dans le tuyau d'aspiration il n'y aurait pas une dépression suffisante à assurer le bon fonctionnement de l'ARIAMAT; dans ce cas-là, il faut créer artificiellement une perte de charge sur le tuyau d'aspiration en fermant graduellement la vanne, pendant le fonctionnement de la pompe, jusqu'à ce que le niveau d'eau dans l'ARIAMAT commence à descendre.

Dans le cas où il est impossible d'atteindre une dépression suffisante à garantir le bon fonctionnement de l'ARIAMAT, il faut utiliser un système d'alimentation d'air avec compresseur et sondes de niveau.

Fourniture

L'ARIAMAT est livré normalement déjà installé sur les réservoirs galvanisés de notre fourniture.

Une fourniture éventuelle avec installation à charge du client est composée par:

n° 1 ARIAMAT complet avec raccord supérieur et valve.
m 1 Tube en polyéthylène avec collier et raccord pour le raccorder à l'aspiration de la pompe.

Pression en m	Capacité de réservoir en litres											
	100	200	300	400	500	750	1000	1500	2000	3000	4000	5000
14/28	AR 300E						AR 1000E					AR 2000E
20/30	AR 300E				AR 1000E							AR 2000E
30/40	AR 300E			AR 1000E						AR 2000E		
35/55	AR 300E			AR 1000E						AR 2000E		
55/70	AR 300E		AR 1000E						AR 2000E			
75/95	AR 300E	AR 1000E				On conseille d'utiliser un compresseur d'air						

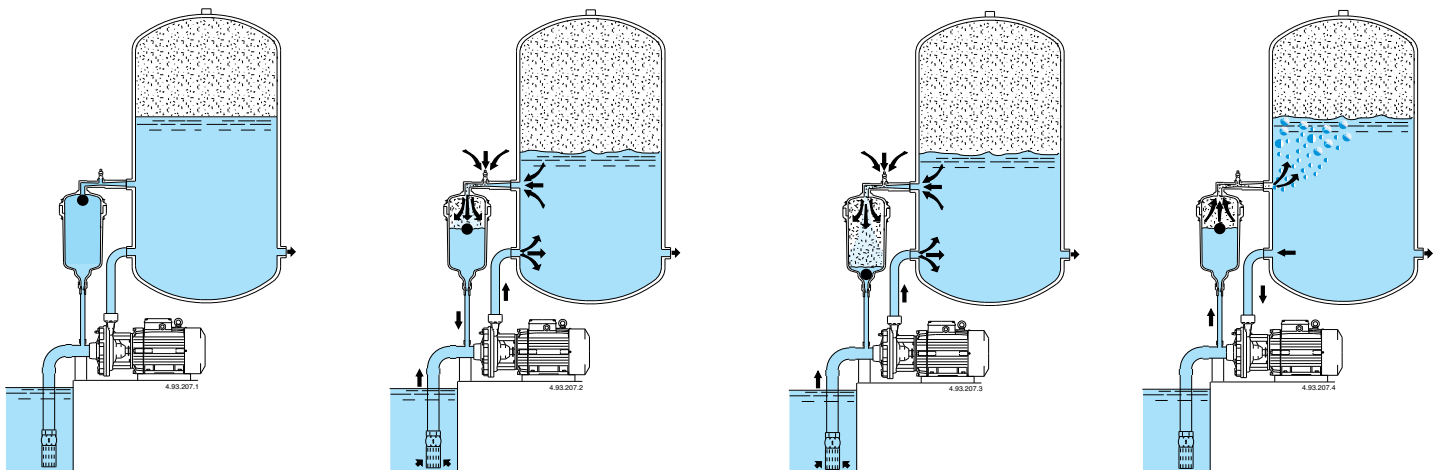

1) Lorsque la pompe est à l'arrêt, le réservoir de l'ARIAMAT est plein d'eau.

2) Au démarrage, la pompe crée une dépression qui aspire l'eau du réservoir de l'ARIAMAT aussi que l'eau du réservoir galvanisé. Le passage d'eau par le venturi provoque une dépression qui aspire l'air extérieur par la valve supérieure.

3) Le niveau d'eau, dans le réservoir de l'ARIAMAT descend jusqu'à ce que l'obturateur flottant vienne fermer l'orifice entre l'ARIAMAT et la pompe. Maintenant l'ARIAMAT est plein d'air.

4) A l'arrêt de la pompe, la pression d'eau du réservoir, chasse l'air de l'ARIAMAT vers le réservoir galvanisé.

CLAPETS



clapet de non-retour

VNR 1
VNR 1 1/4
VNR 1 1/2
VNR 2

clapet de pied

VDF 1
VDF 1 1/4
VDF 1 1/2
VDF 2

MANOMETRES



type avec connection axiale

MA 0-6
MA 0-6 ABS

type avec connection radiale

MR 0-10
MR 0-12
MR 0-16

RACCORD



type	connection
RA5 H 92	G 1
RA5 H 105	G 1

MOTOR COVER PROTECTION KIT



Type	Motor kW
Ø 157 cover	0,75 ÷ 2,2
Ø 180 cover	3 ÷ 4
Ø 223 cover	5,5 ÷ 7,5
Ø 263 cover	9,2 ÷ 18,5
Ø 314 cover	22 ÷ 30

The kit includes: 1 Plate
1 Cilinder
2 Screws
1 Washer

RESERVOIR SPHERIQUE



type	connect.	capacité
SS 24	G 1	24 l

Membrane en BUTYLE.

RESERVOIR



réservoir avec base et pieds

type	connect.	capacité
SC 20 BP	G 1	20 l

Membrane en BUTYLE.

RESERVOIR CYLINDRIQUE EN INOX



réservoir cylindrique vertical

type	connect.	capacité
SCX 20	G 1	20 l

Membrane en BUTYLE.

RESERVOIR CYLINDRIQUE EN INOX



réservoir avec base et pieds

type	connect.	capacité
SCX 20 BP	G 1	20 l

Membrane en BUTYLE.

ACCESSOIRES



KIT 1



Type	KIT 1A	KIT 1B	KIT 1CX	KIT 1DX
Composants				
Raccord	RA5 H 92	RA5 H 92	RA5 H 92	RA5 H 92
Pressostat	FSG 2	FYG 22	FSG 2	FYG 22
Manomètre	MA 0-6 ABS	MR 0-10	MA 0-6 ABS	MR 0-10
Réservoir	SS 24	SS 24	SCX 20	SCX 20

KIT 2



Type	KIT 2A	KIT 2B	KIT 2CX	KIT 2DX
Composants				
Raccord	RA5 H 92	RA5 H 92	RA5 H 92	RA5 H 92
Pressostat	FSG 2	FYG 22	FSG 2	FYG 22
Manomètre	MA 0-6 ABS	MR 0-10	MA 0-6 ABS	MR 0-10
Tuyau flexible	FP 1-680	FP 1-680	FP 1-680	FP 1-680
Coude	1" M.F.	1" M.F.	1" M.F.	1" M.F.
Coude	1" F.F.	1" F.F.	1" F.F.	1" F.F.
Réservoir	SC 20 BP	SC 20 BP	SCX 20 BP	SCX 20 BP

SONDES DE NIVEAU



type

SL 2 sondes
SLA Sondes de niveau connectées
 Câble 2x0,75 mm²
 (longueur du câble sur demande)

exemple: **SLA 30**
 Sondes de niveau connectées
 30 m câble

FLOTTEUR



type

INTGALL
 (2,5 m de câble)

TUYAU FLEXIBLE

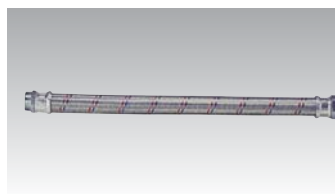

type

d x longueur

FP 1-630 G 1 x 630
FP 1-680 G 1 x 680

motralec

4 rue Lavoisier . ZA Lavoisier . 95223 HERBLAY CEDEX

Tel. : 01.39.97.65.10 / Fax. : 01.39.97.68.48

Demande de prix / e-mail : service-commercial@motralec.com

www.motralec.com