

PLAGES D'UTILISATION

Débits jusqu'à :	600 m ³ /h
Hauteurs mano. jusqu'à :	100 m
Pression de service maxi :	13 bar jusqu'à +140°C
	16 bar jusqu'à +120°C
Température :	-20° à +140°C
DN orifices :	32 à 200

DIL

POMPES IN-LINE DOUBLES Chauffage - Climatisation 50 Hz

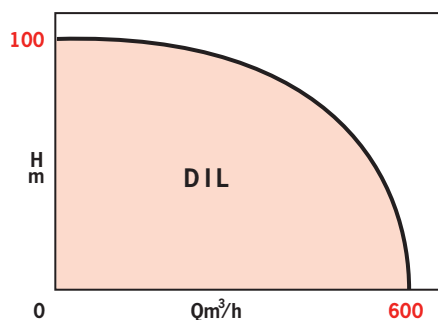

APPLICATIONS

- Circuits d'eau de chauffage suivant VDI2035
- Circuits d'eau glacée, d'eau glycolée (de 20 à 40% de glycol) et T° maxi 40°C
- Circuits d'eau de refroidissement
- Pour toutes industries où il s'agit de pomper des liquides clairs, sans particules abrasives, chimiquement neutres et non explosifs.

AVANTAGES



6 6 4 8 1 6 5

Accédez aux vidéos thématiques autour de ce produit depuis votre téléphone portable



- Hauts rendements hydrauliques
- Faibles consommations électriques
- Montage direct sur tuyauterie (horizontale ou verticale) ou sur massif
- Faibles niveaux sonores
- Interchangeabilité complète entre pompes simples et pompes doubles
- Entretien pratiquement nul.



CONCEPTION

• Partie hydraulique

- Centrifuge monocellulaire
- Corps à brides, orifices IN-LINE
- Brides équipées d'orifices de prise de pression
- Roues équilibrées hydrauliquement et dynamiquement
- Etanchéité par garniture mécanique normalisée
- Lanterne

Equipée de trous de récupération des condensats, en position verticale et horizontale

• Moteur

Normalisé à brides. Accouplé à la pompe par accouplement rigide

Vitesse : 1450 et 2900 tr/mn

Bobinage tri ≤ 3 kW : 230 V Δ 50 Hz

400 V Y 50 Hz

tri ≥ 4 kW : 400 V Δ 50 Hz

Classe d'Isolation : 155 (F)

Indice de protection : IP55

Conformité CE : EN 809

Options : protection ipsothermique, 60 Hz...
(nous consulter)

CONSTRUCTION DE BASE

Pièces principales	Matériau
Corps de pompe	Fonte EN GJL 250
Roue	Fonte EN GJL 200 Bronze*
Lanterne	Fonte EN GJL 250
Arbre	Acier X39 Cr Mo 17.1
Garniture mécanique**	Graphite/Carbure Si/EP

* Options

** Autres garnitures mécaniques, nous consulter

IDENTIFICATION

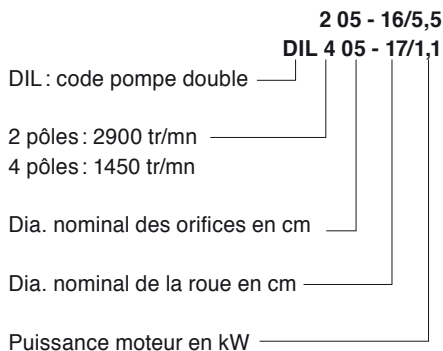

PLAN-COUPÉ DE PRINCIPE

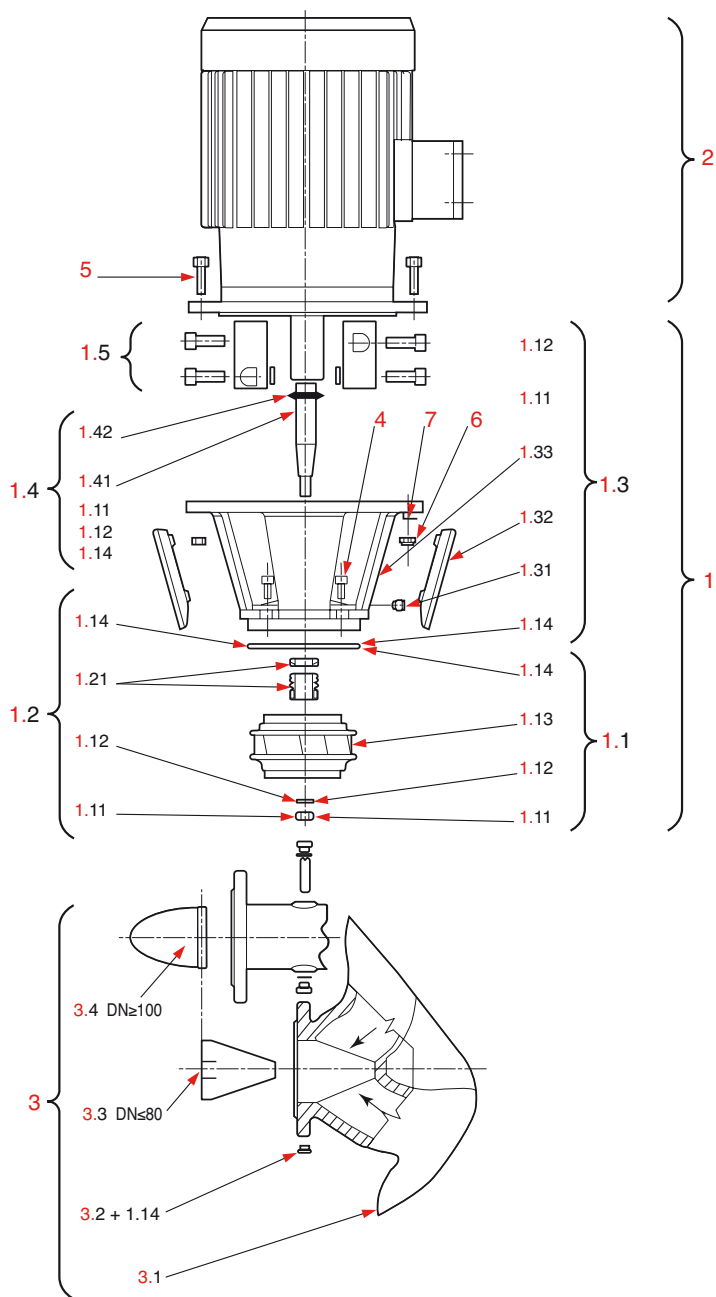

1. Lot complet

- 1.1 Jeu de pièces détachées avec
 - 1.11 Ecrou
 - 1.12 Rondelle
 - 1.13 Roue
 - 1.14 Joint torique
- 1.2 Jeu de pièces détachées garniture mécanique avec
 - 1.21 Garniture mécanique complète
- 1.3 Jeu de pièces détachées lanterne avec
 - 1.31 Vis de purgeur
 - 1.32 Protecteur d'accouplement
 - 1.33 Lanterne

1.4 Jeu de pièces détachées arbre avec

- 1.41 Arbre
- 1.42 Bague d'arrêt ressort
- 1.5 Accouplement complet

2. Moteur

3. Corps de pompe complet avec

- 3.1 Corps de pompe
- 3.2 Bouchon pour les orifices de pression
- 3.3 Volet directionnel ≤ DN 80
- 3.4 Volet directionnel ≥ DN 100

4. Vis de fixation pour lanterne/pompe

- 5. Vis de fixation pour moteur/lanterne
- 6. Ecrou pour fixation moteur/lanterne
- 7. Rondelle pour fixation moteur/lanterne

ABAQUES GÉNÉRAUX DE PRÉSELÉCTION

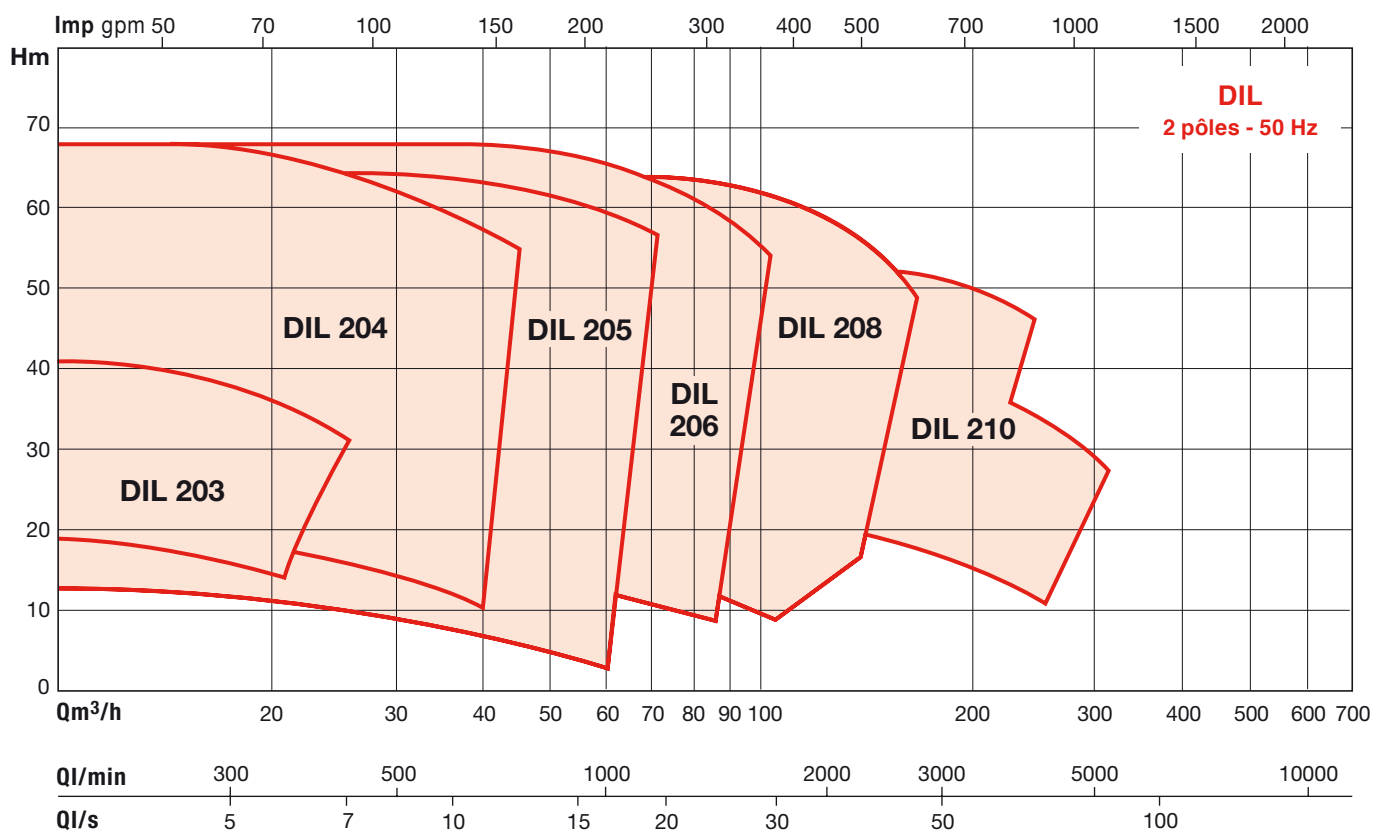
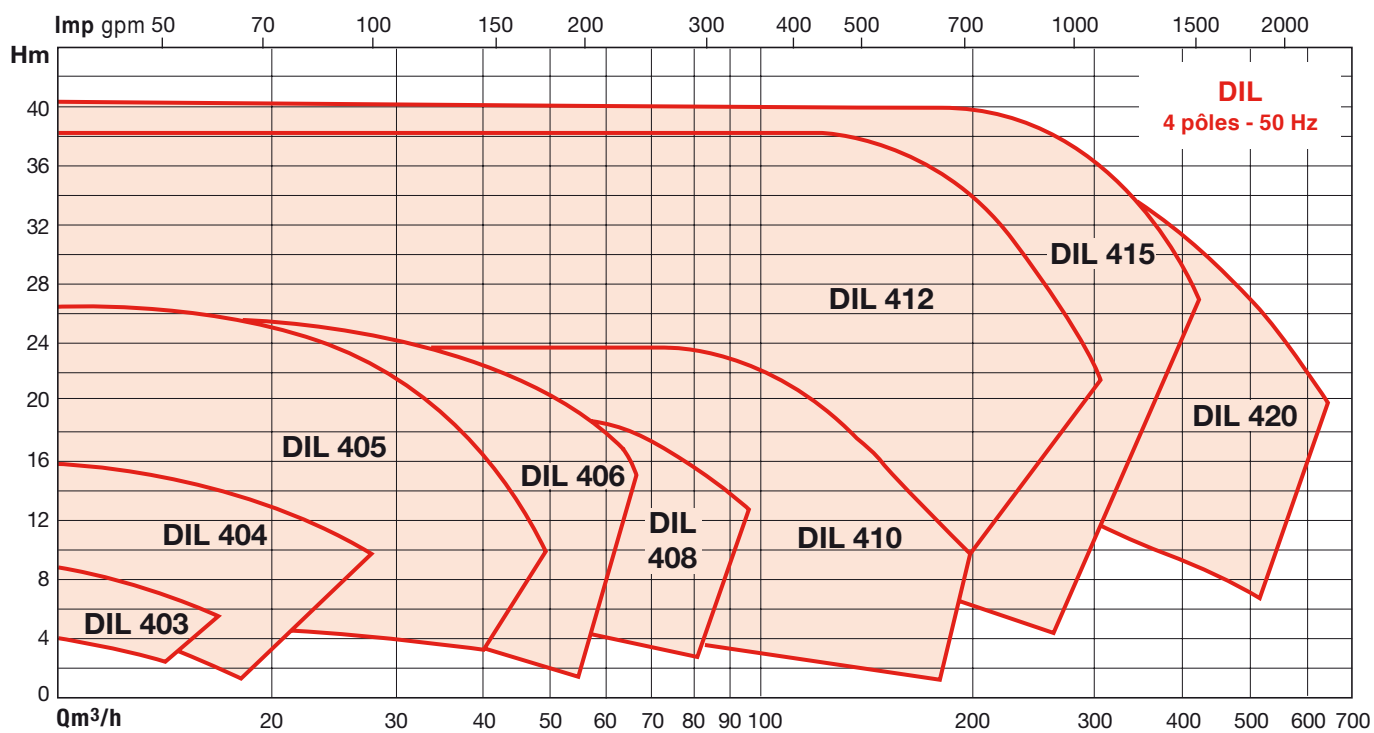

PERFORMANCES HYDRAULIQUES DIL 4 PÔLES

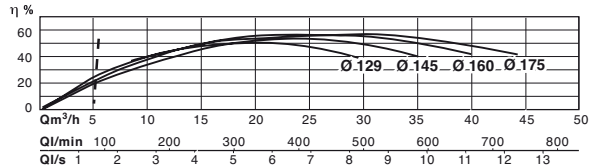
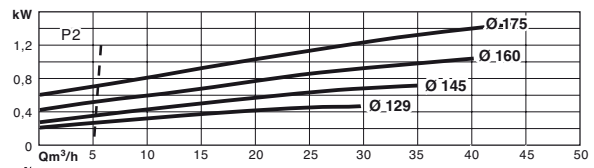
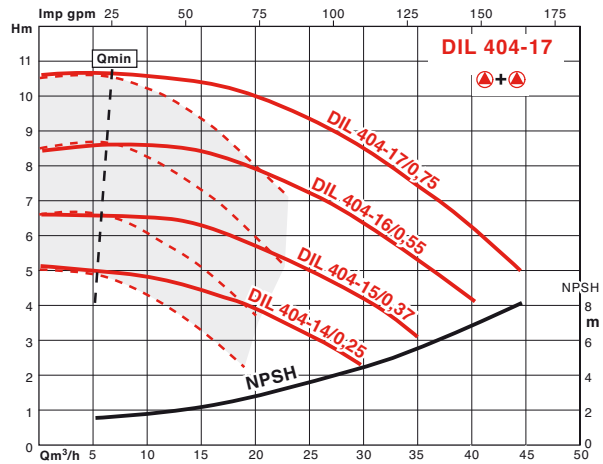
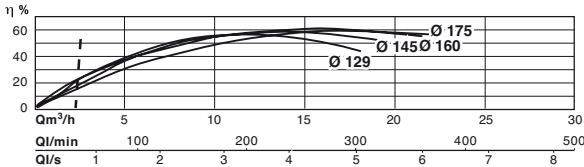
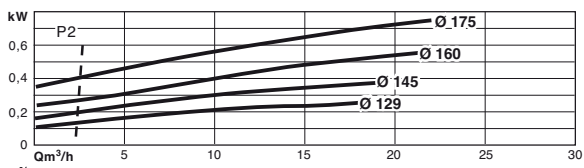
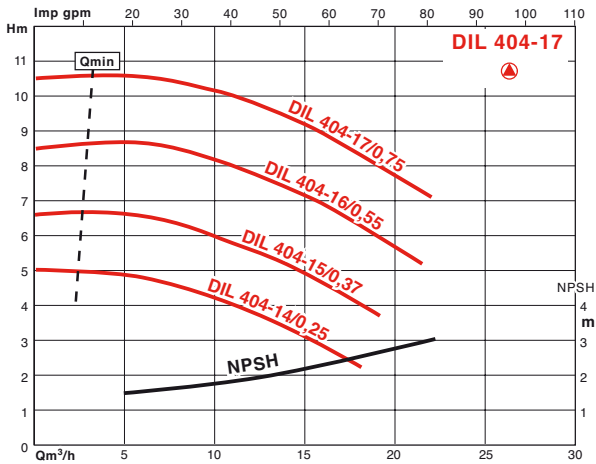
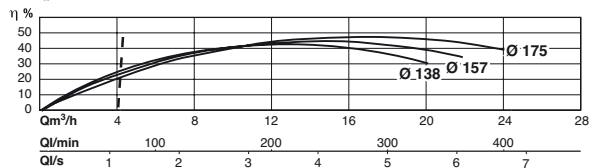
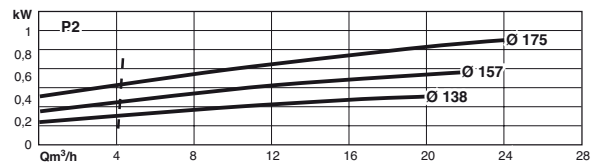
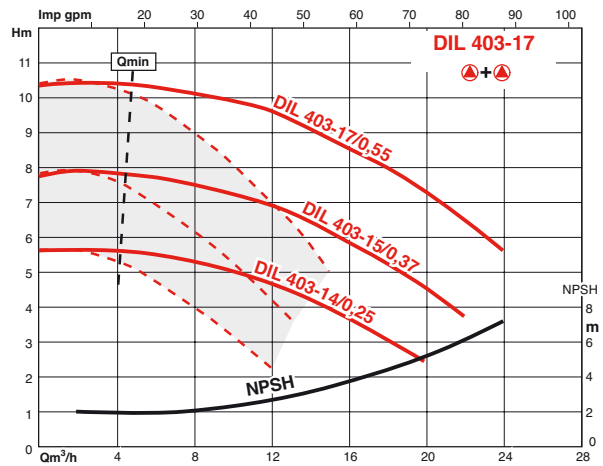
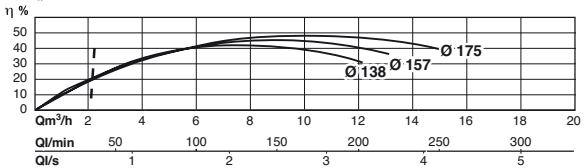
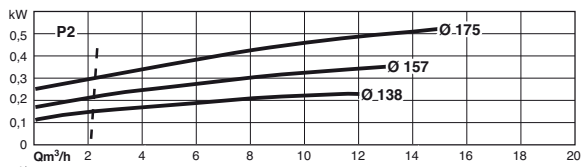
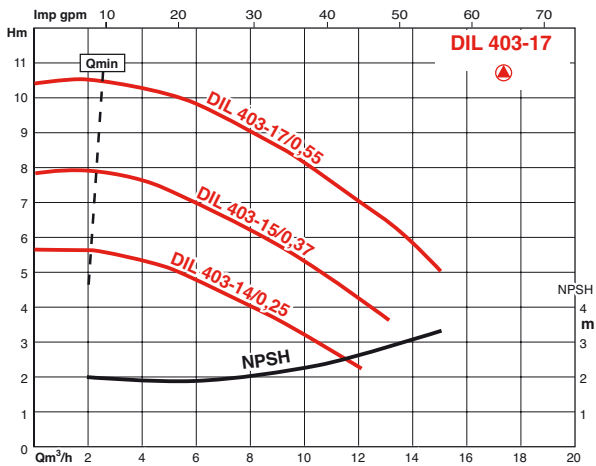

PERFORMANCES HYDRAULIQUES DIL 4 PÔLES

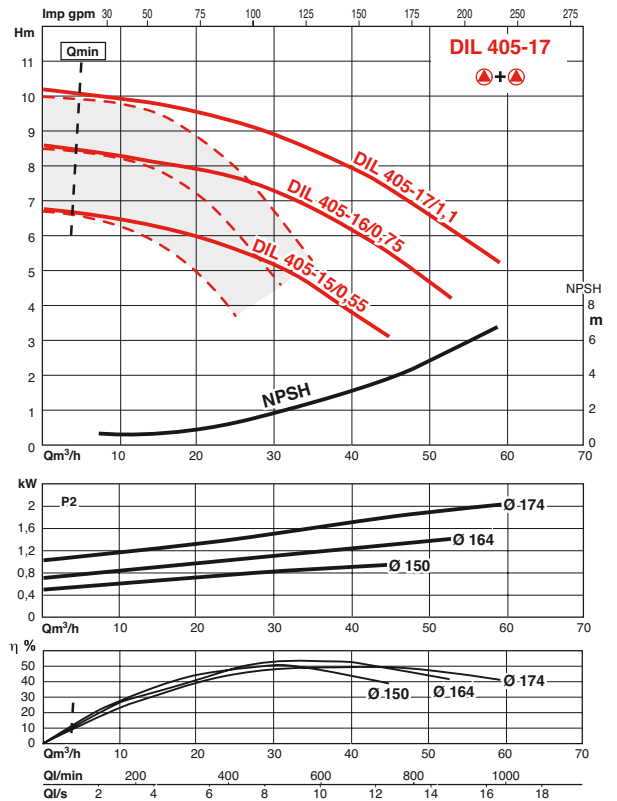
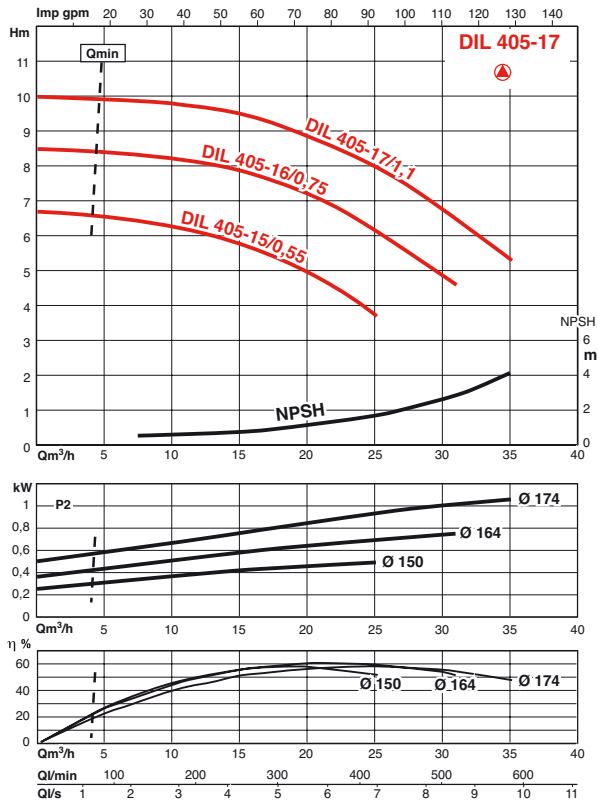
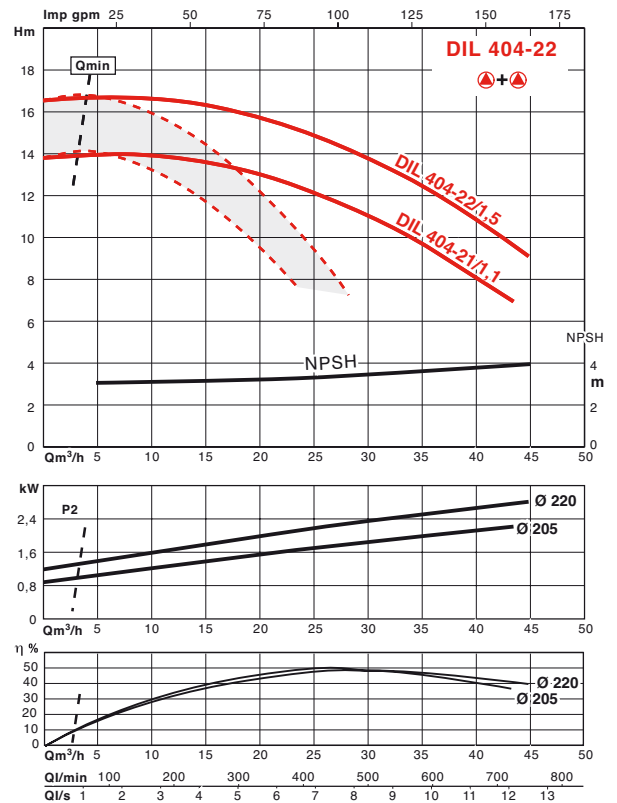
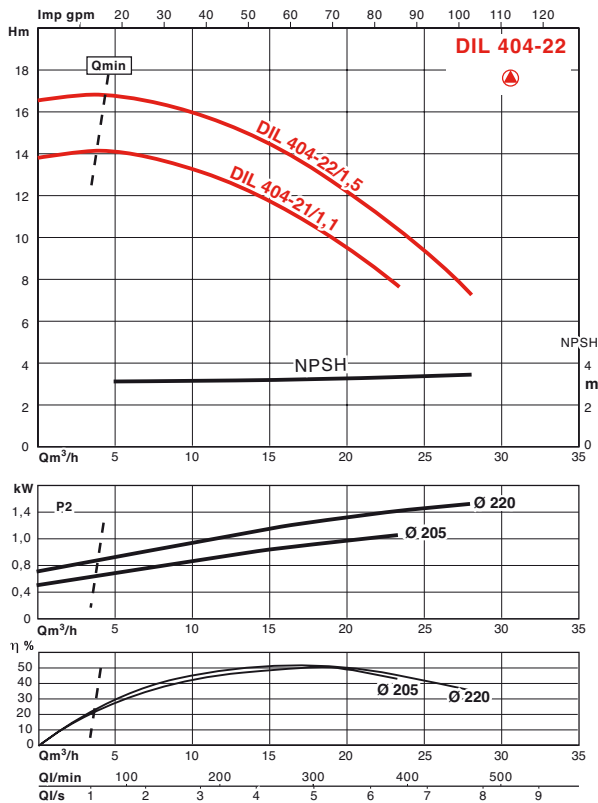

PERFORMANCES HYDRAULIQUES DIL 4 PÔLES

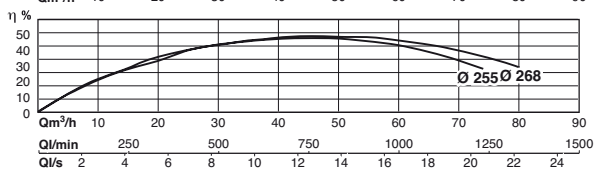
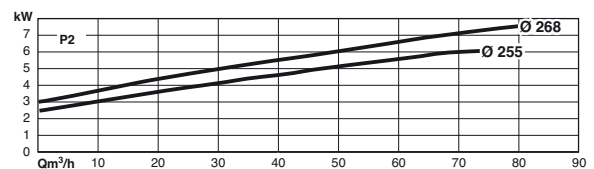
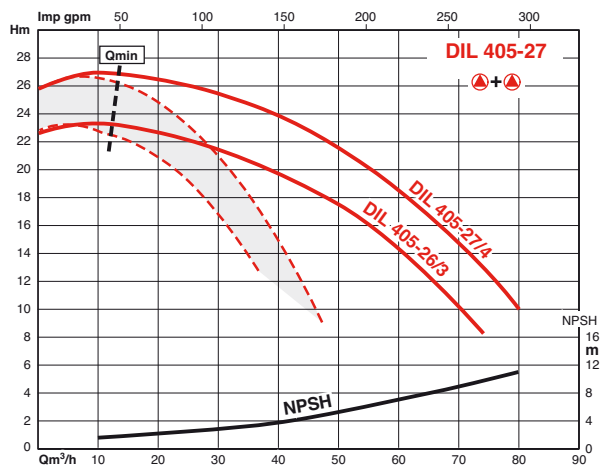
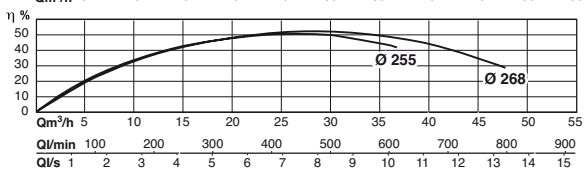
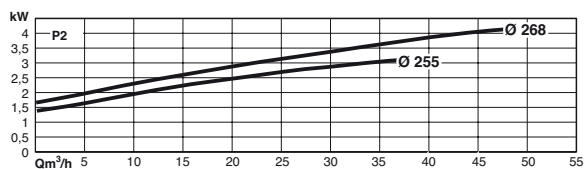
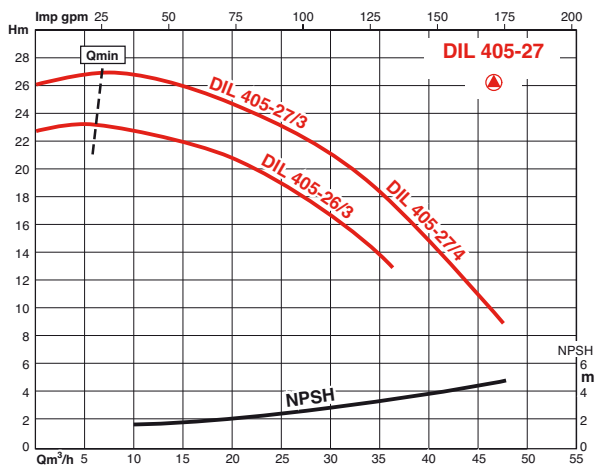
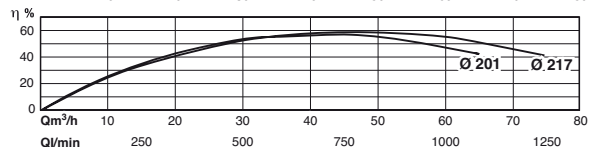
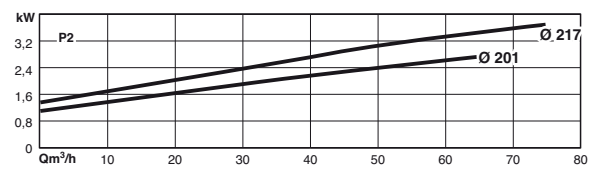
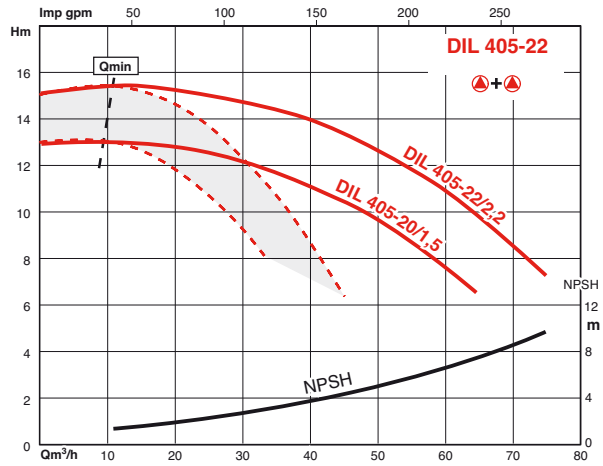
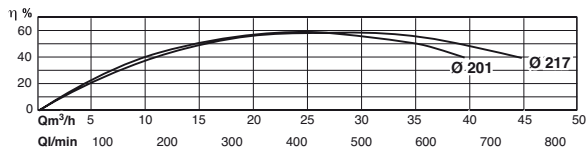
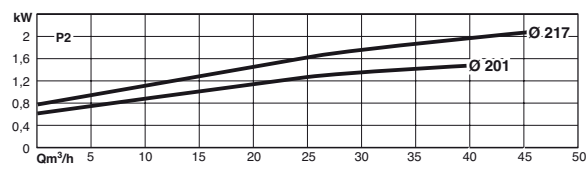
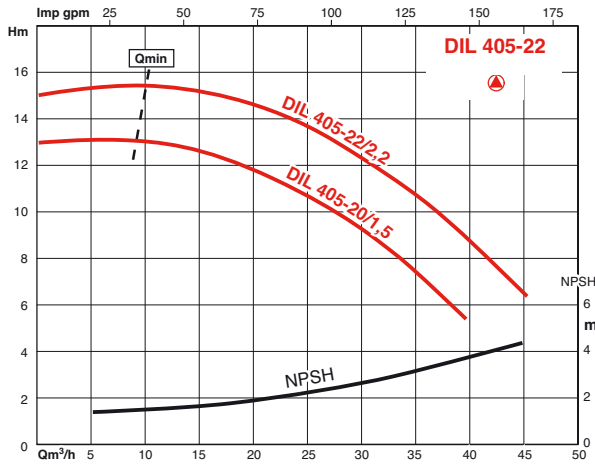

PERFORMANCES HYDRAULIQUES DIL 4 PÔLES

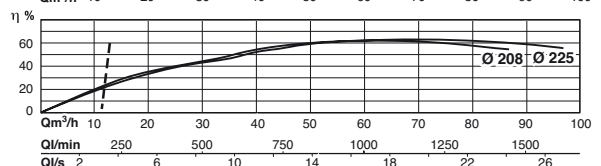
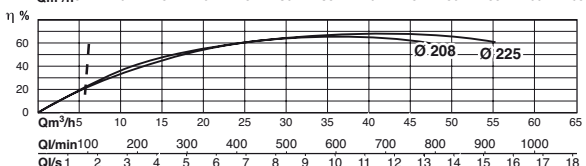
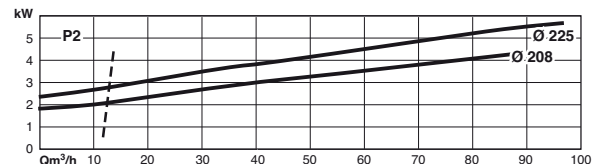
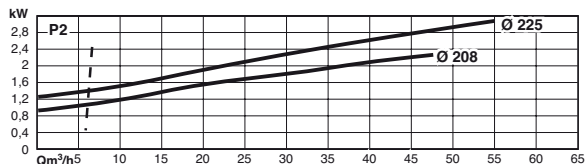
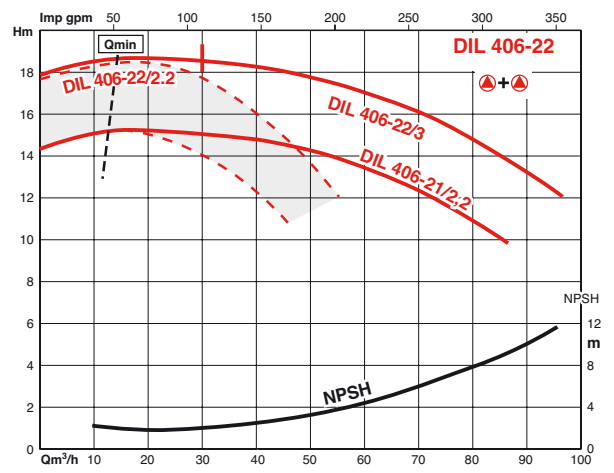
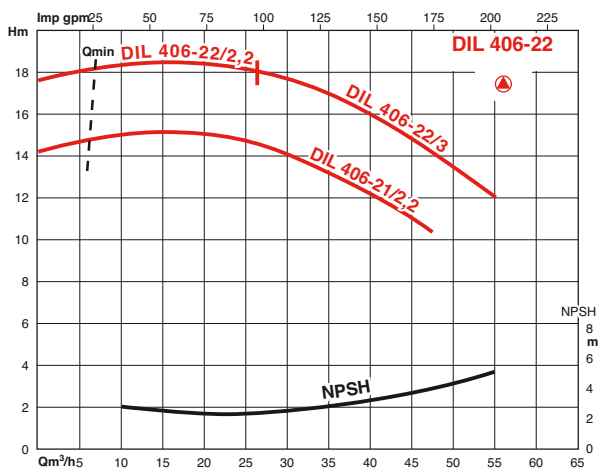
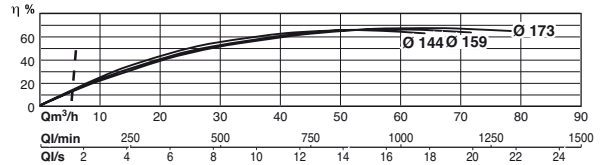
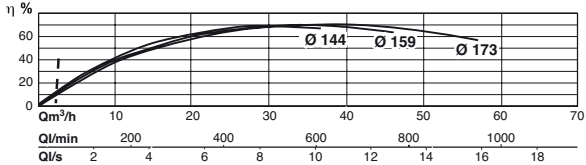
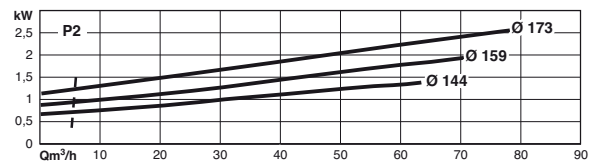
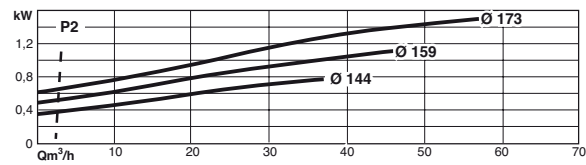
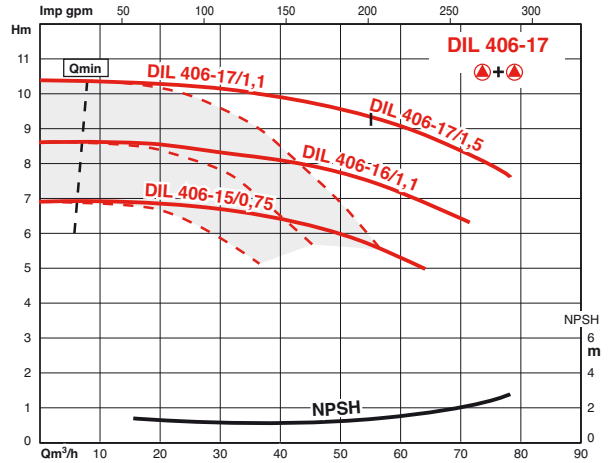
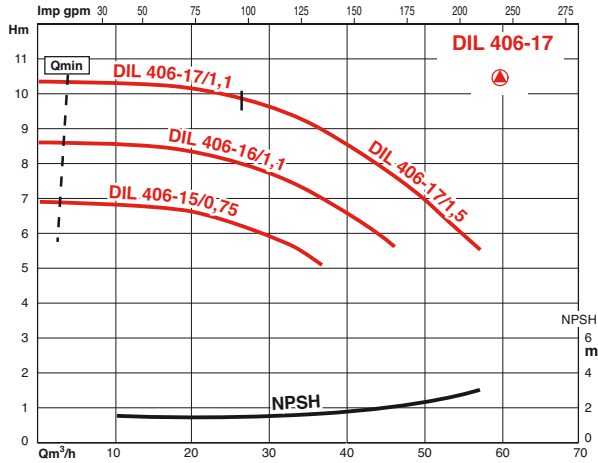

PERFORMANCES HYDRAULIQUES DIL 4 PÔLES

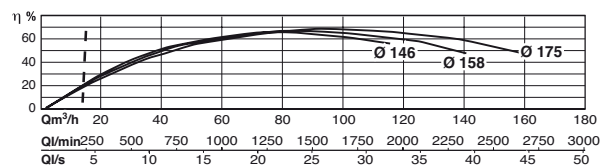
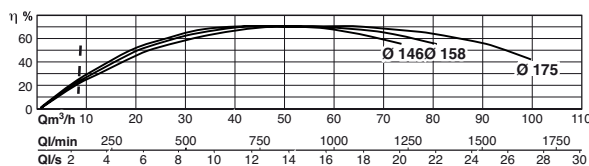
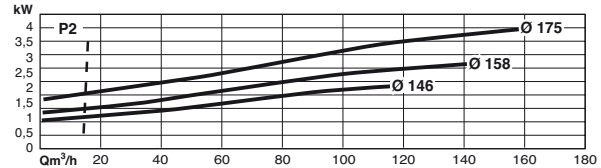
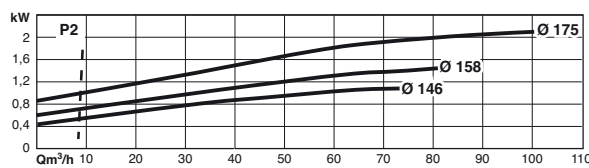
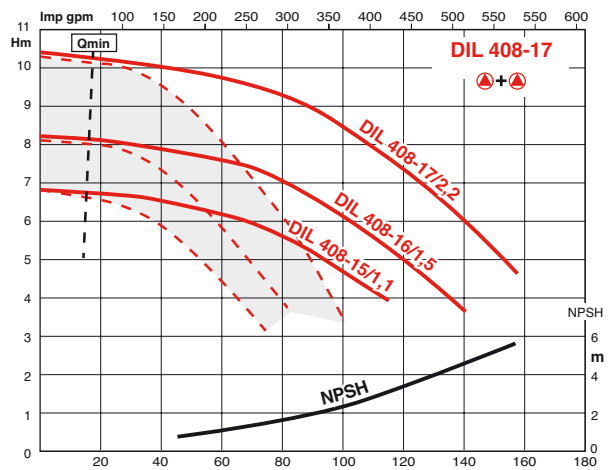
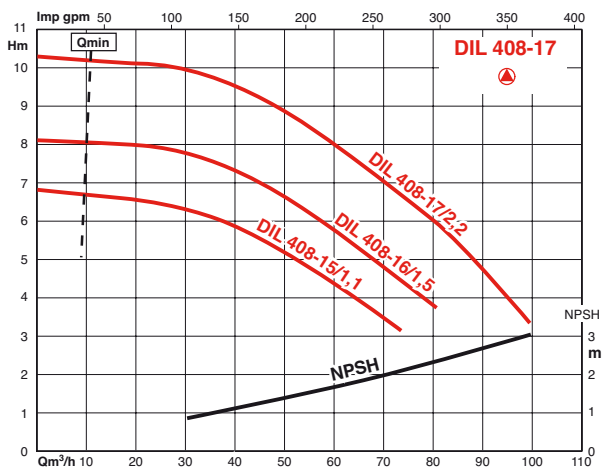
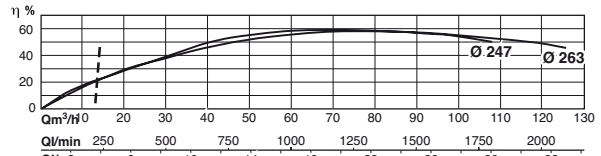
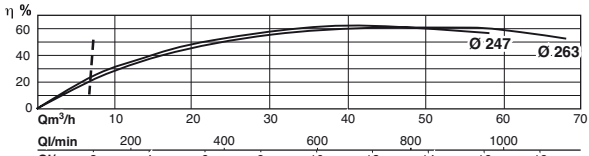
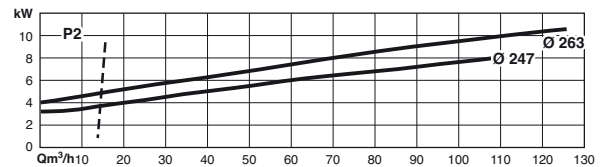
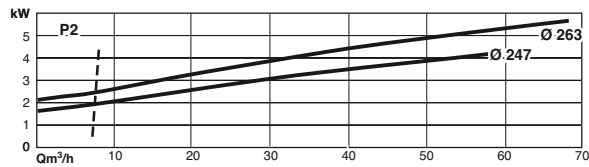
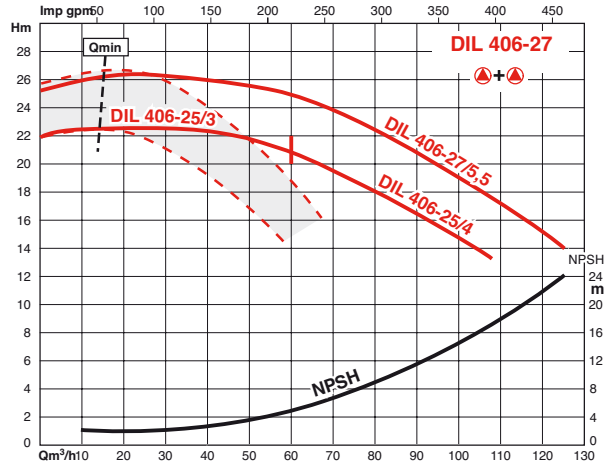
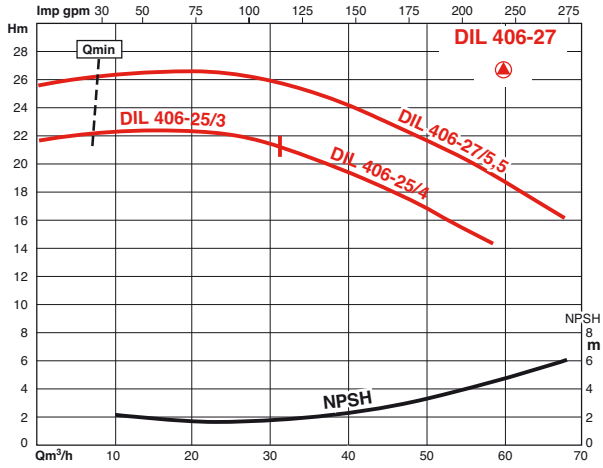

PERFORMANCES HYDRAULIQUES DIL 4 PÔLES

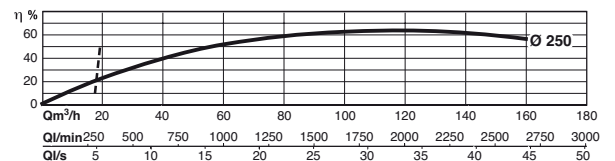
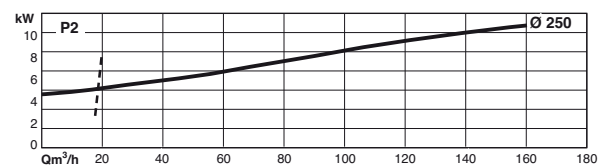
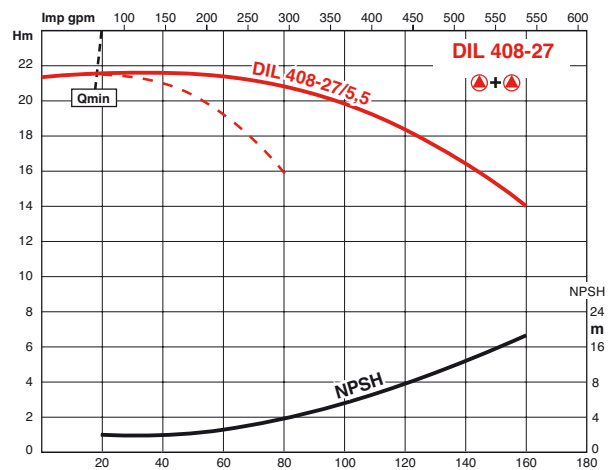
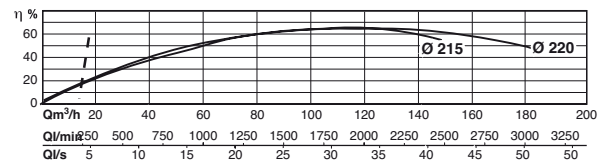
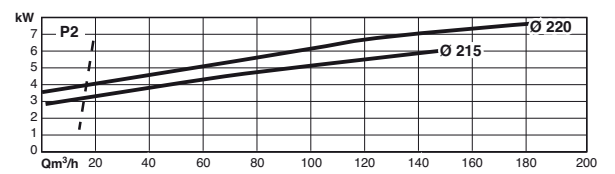
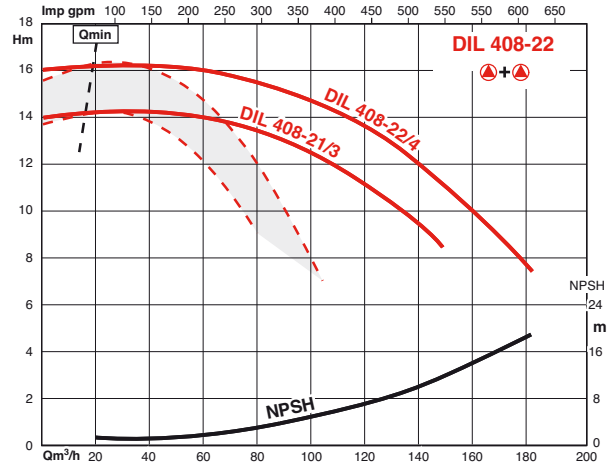
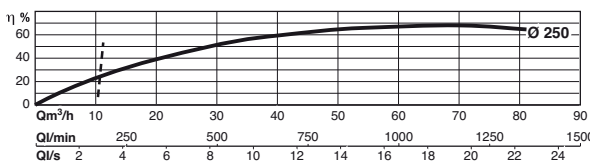
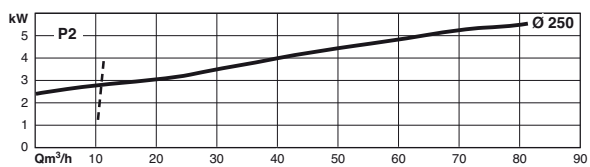
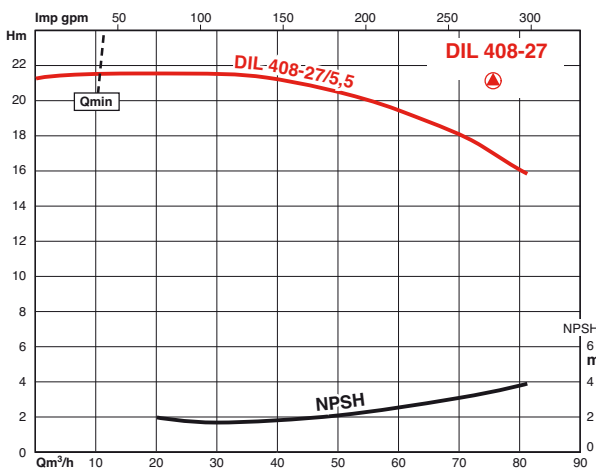
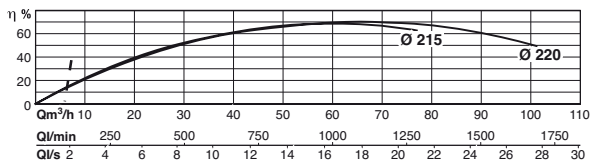
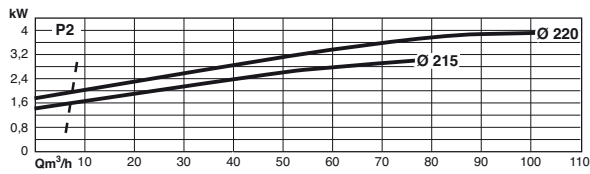
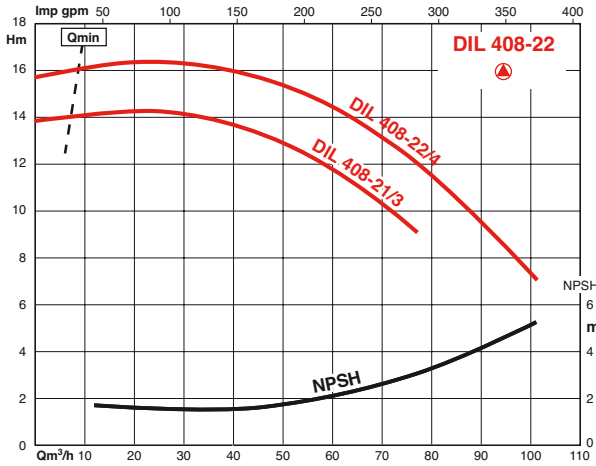

PERFORMANCES HYDRAULIQUES DIL 4 PÔLES

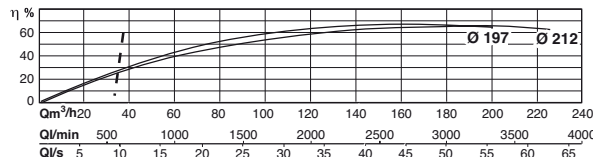
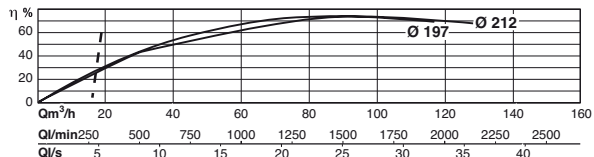
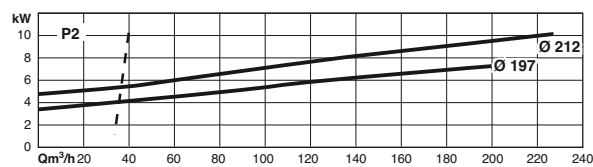
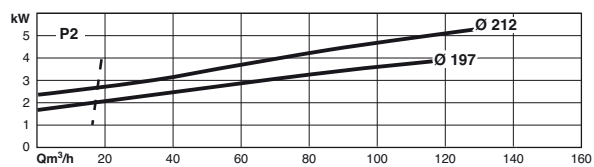
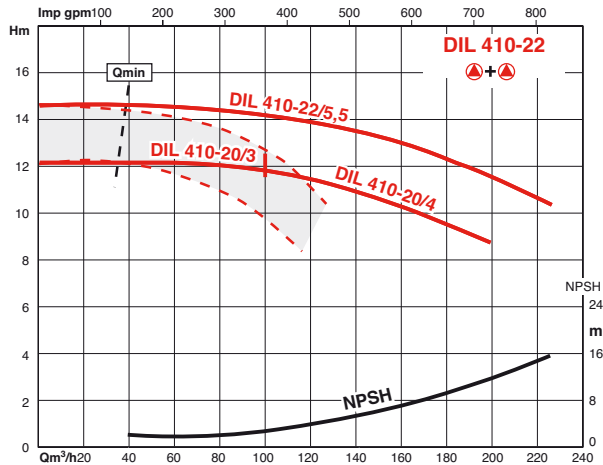
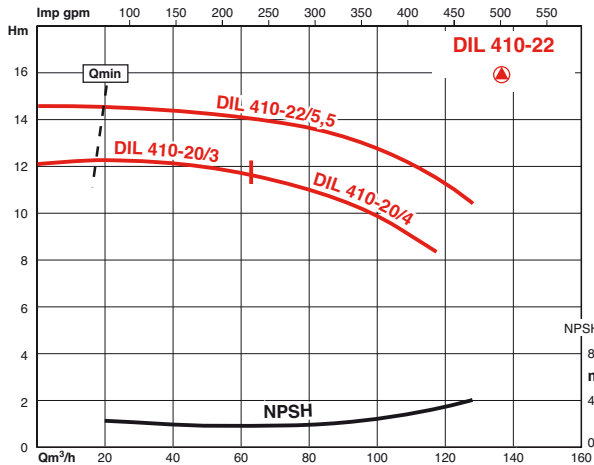
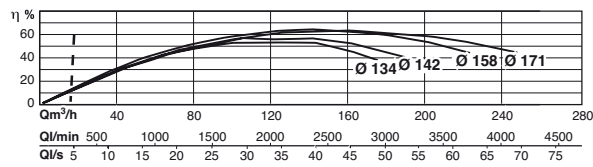
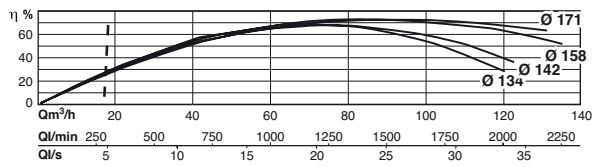
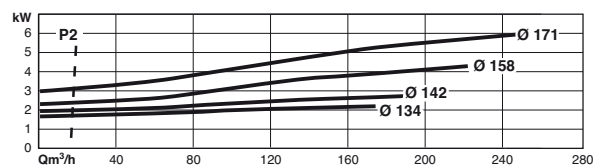
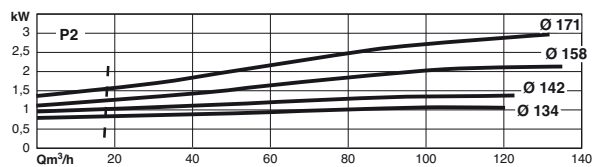
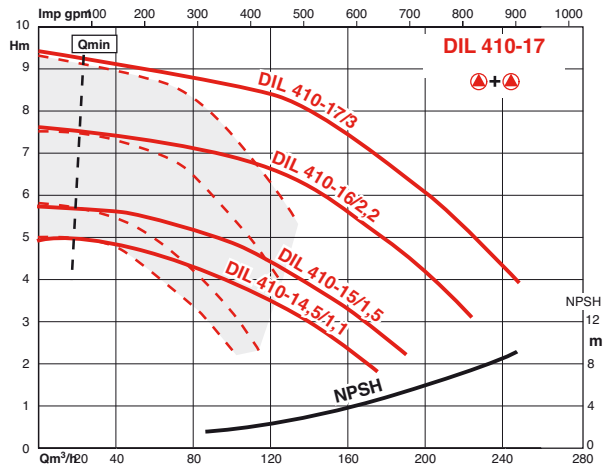
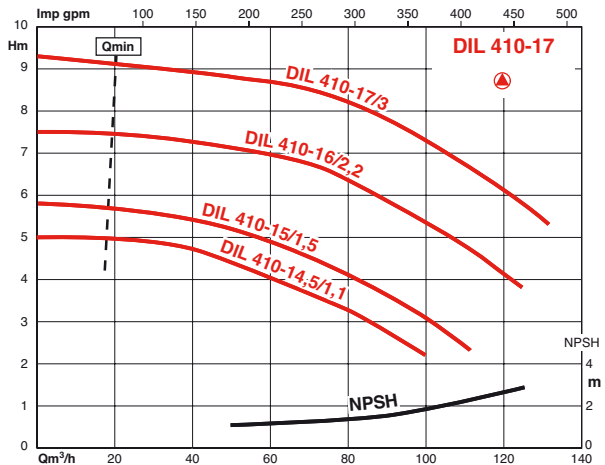

PERFORMANCES HYDRAULIQUES DIL 4 PÔLES

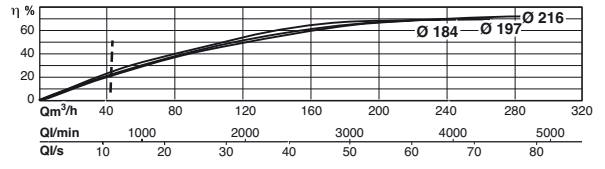
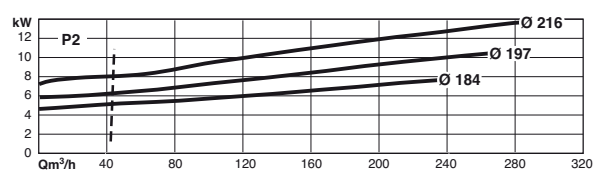
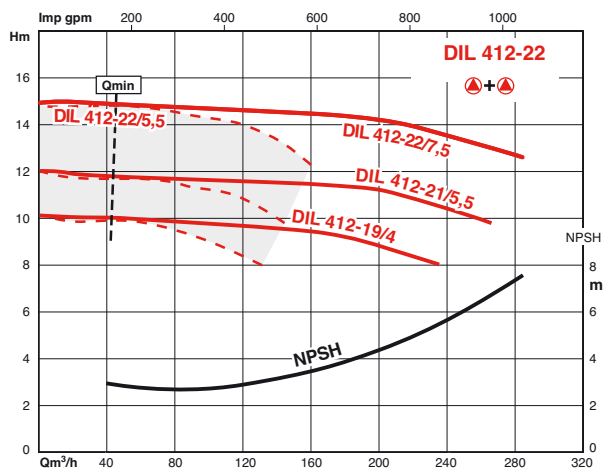
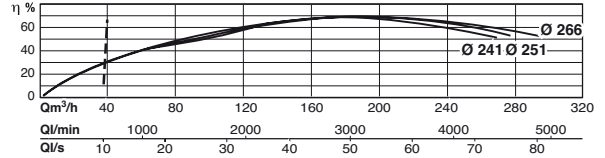
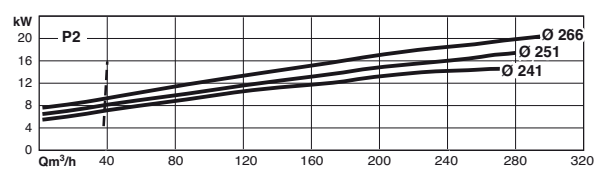
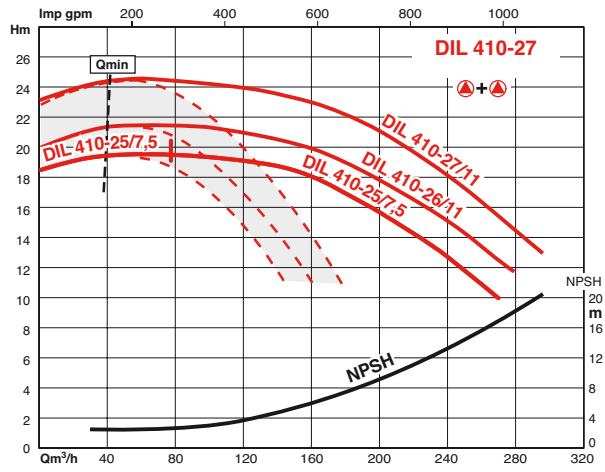
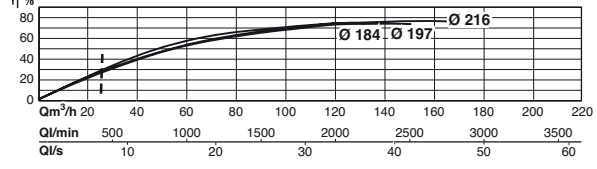
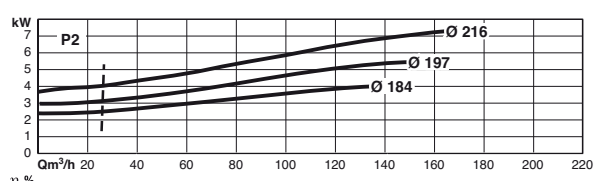
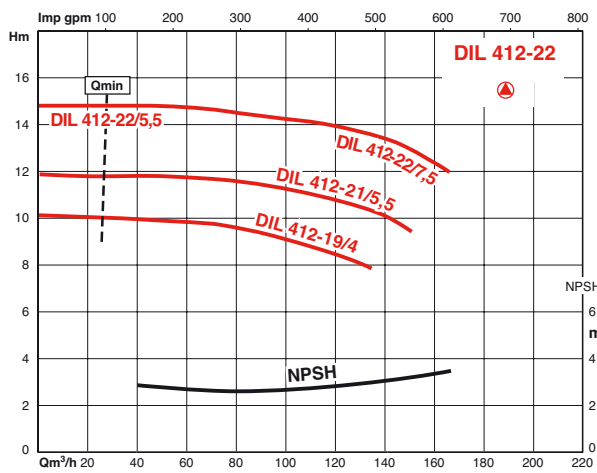
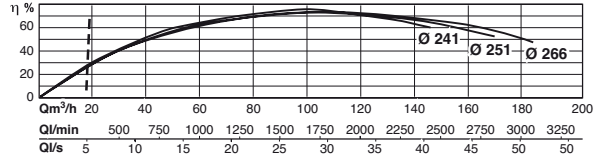
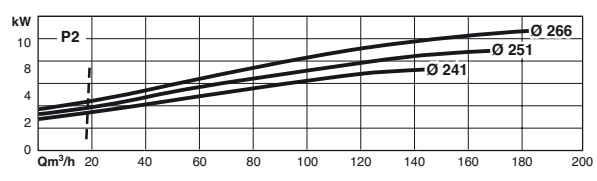
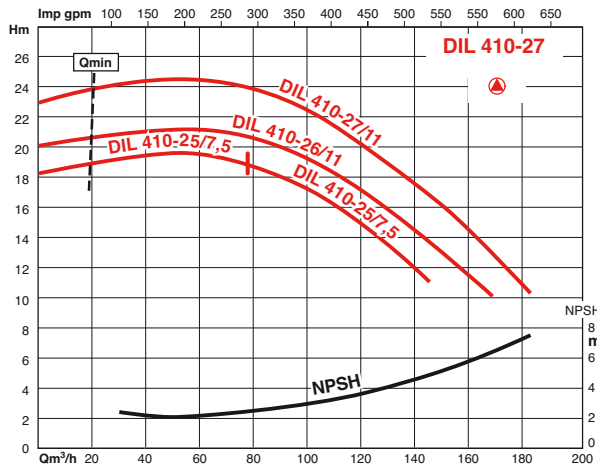

PERFORMANCES HYDRAULIQUES DIL 4 PÔLES

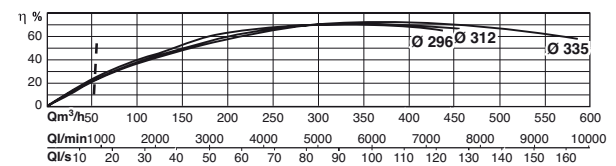
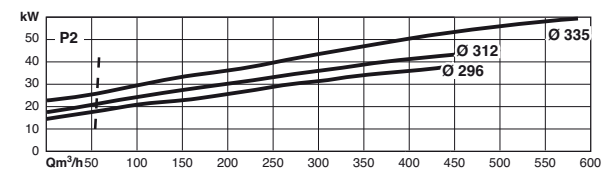
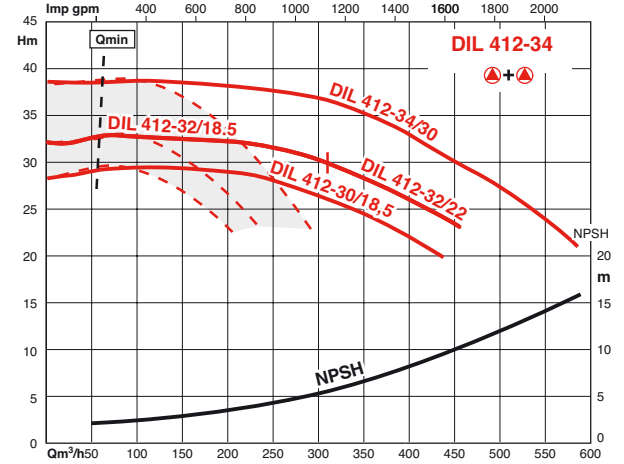
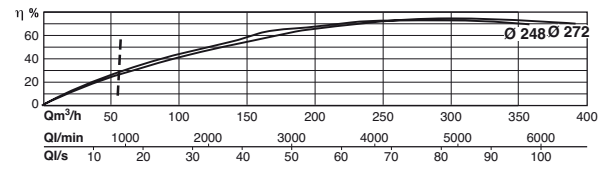
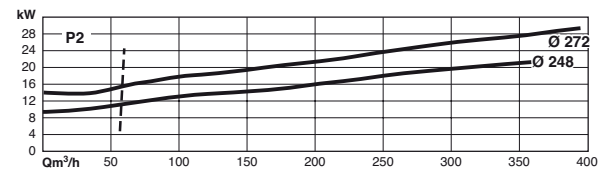
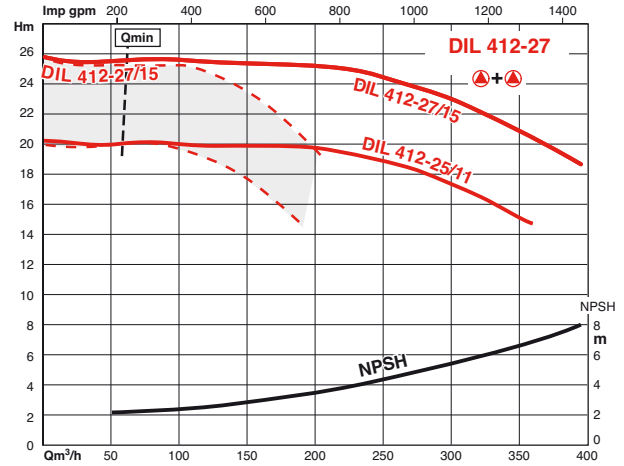
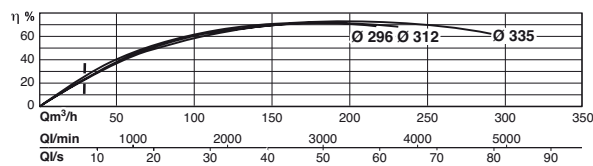
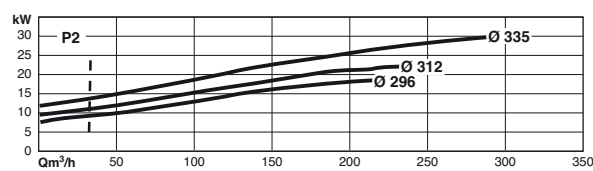
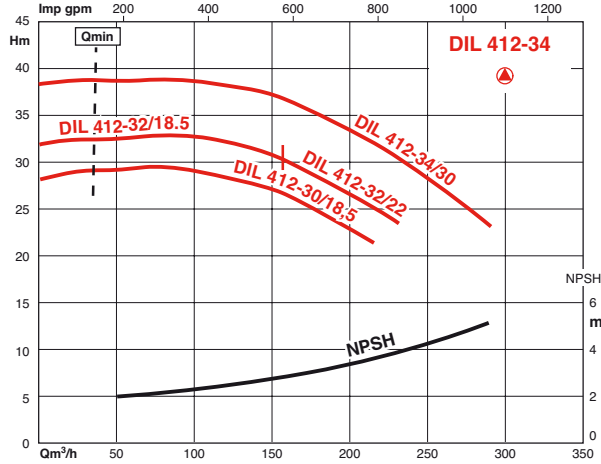
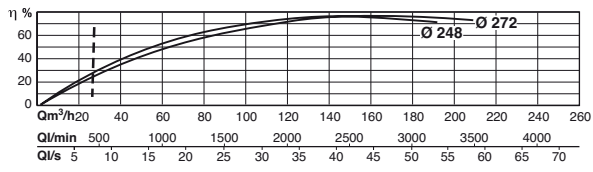
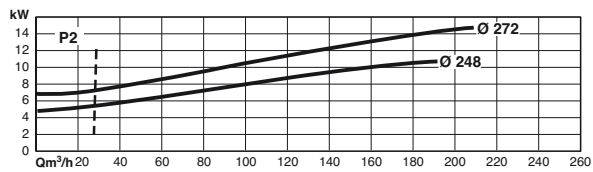
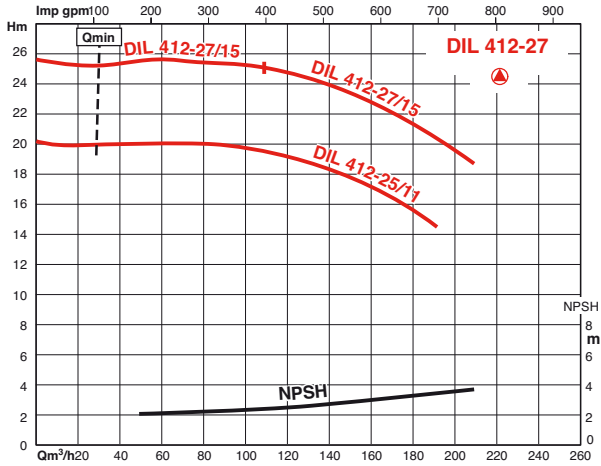

PERFORMANCES HYDRAULIQUES DIL 4 PÔLES

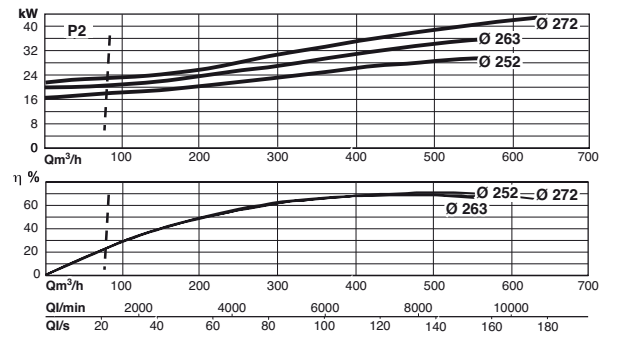
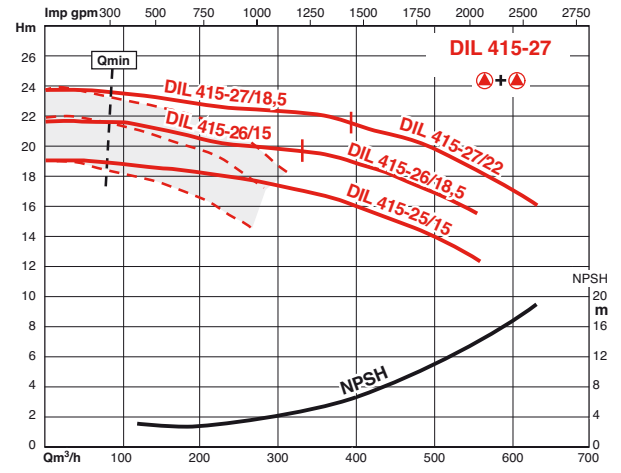
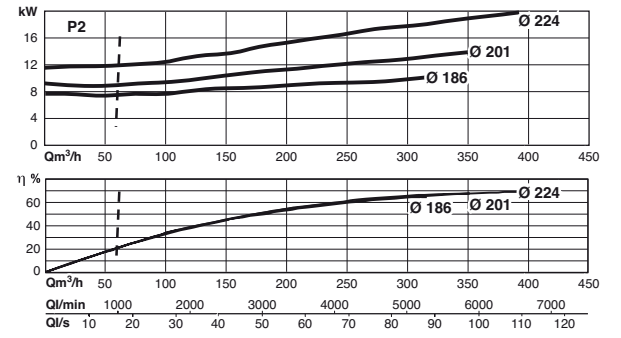
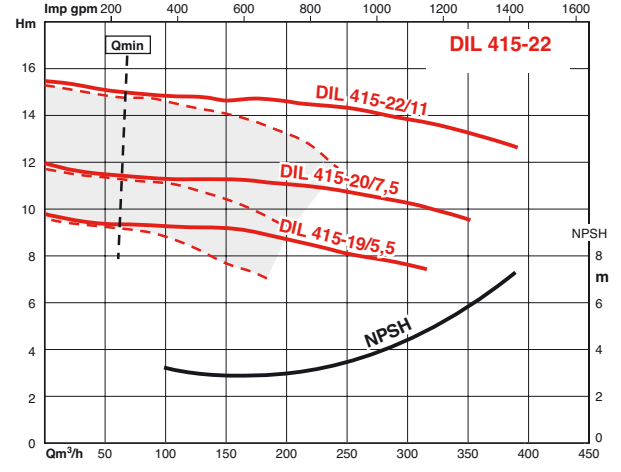
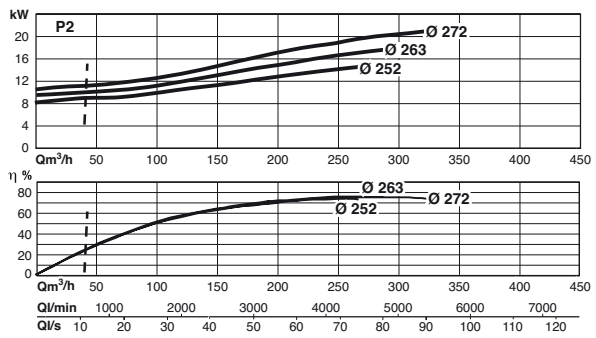
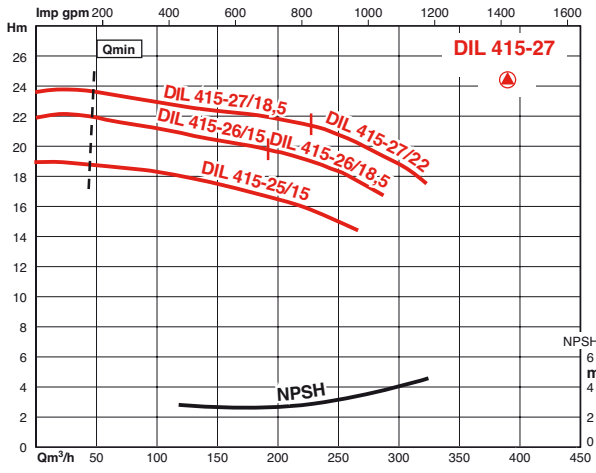
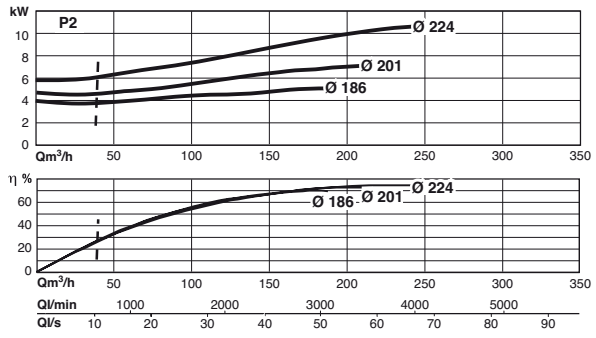
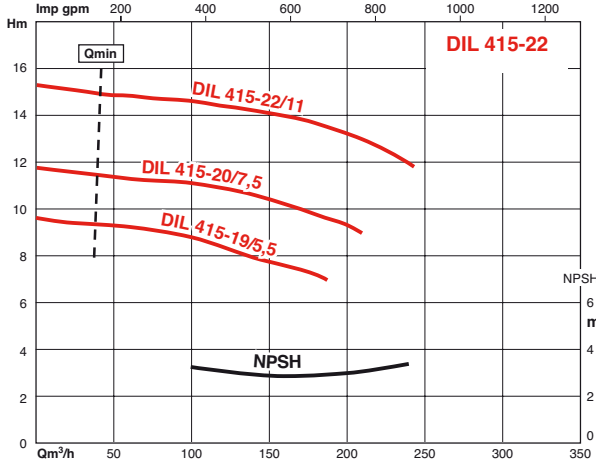

PERFORMANCES HYDRAULIQUES DIL 4 PÔLES

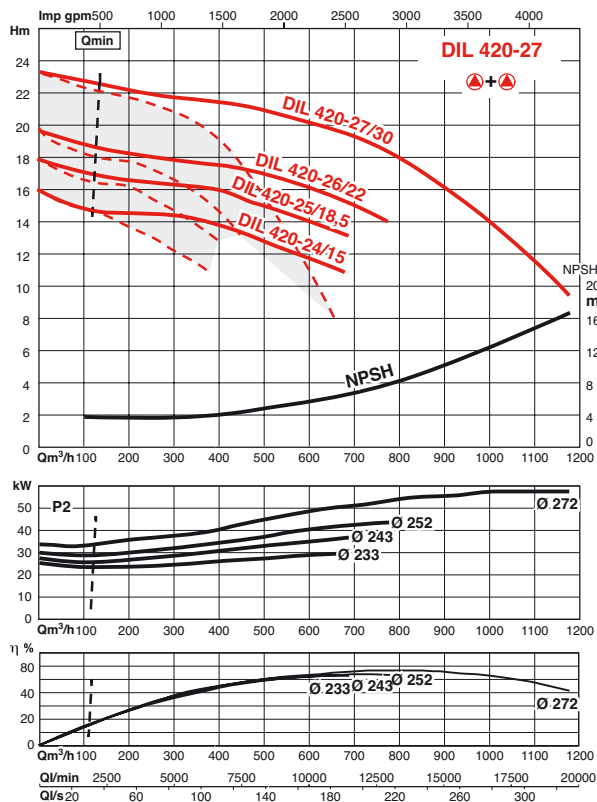
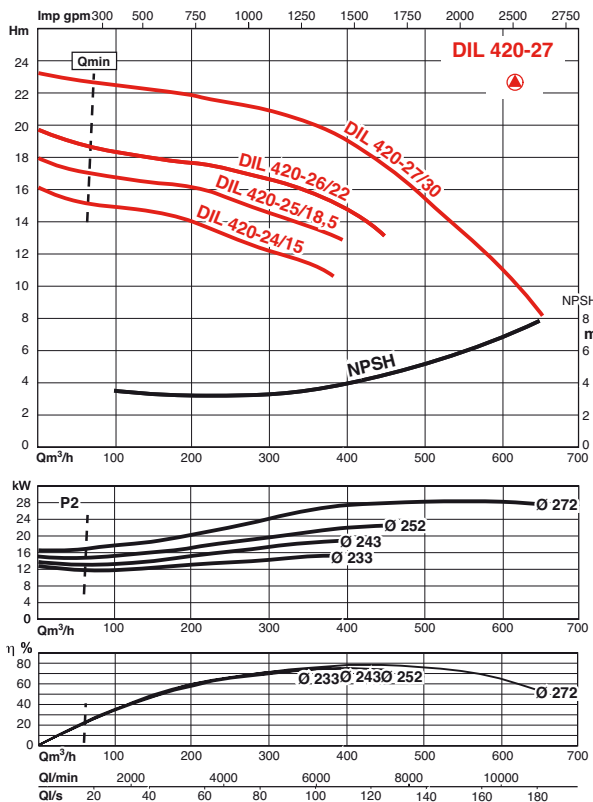
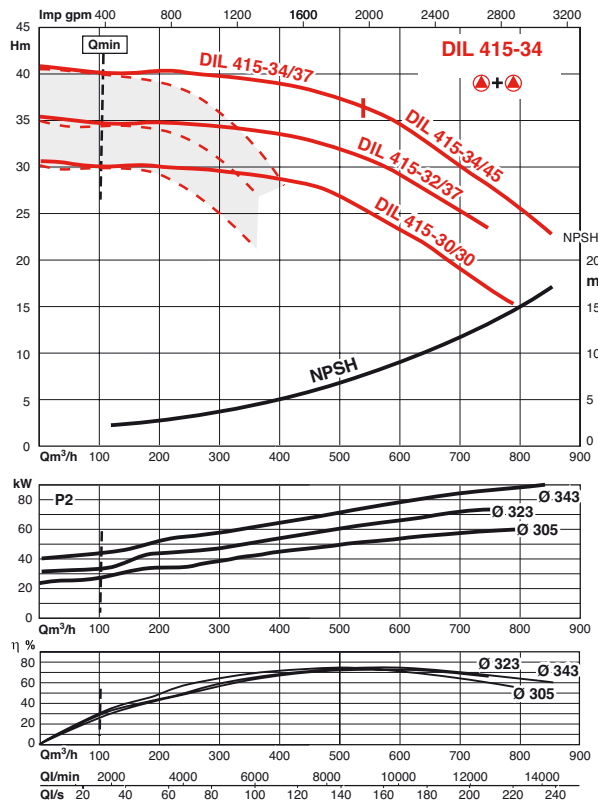
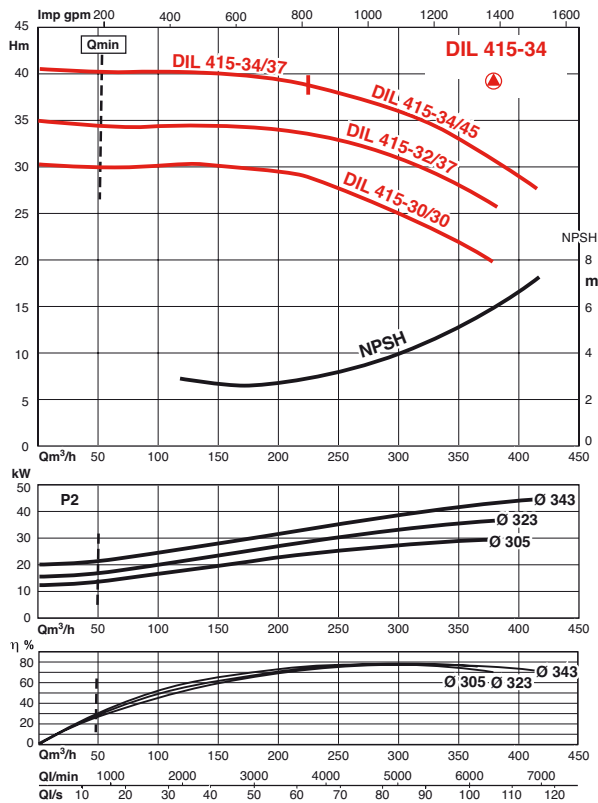

PERFORMANCES HYDRAULIQUES DIL 4 PÔLES

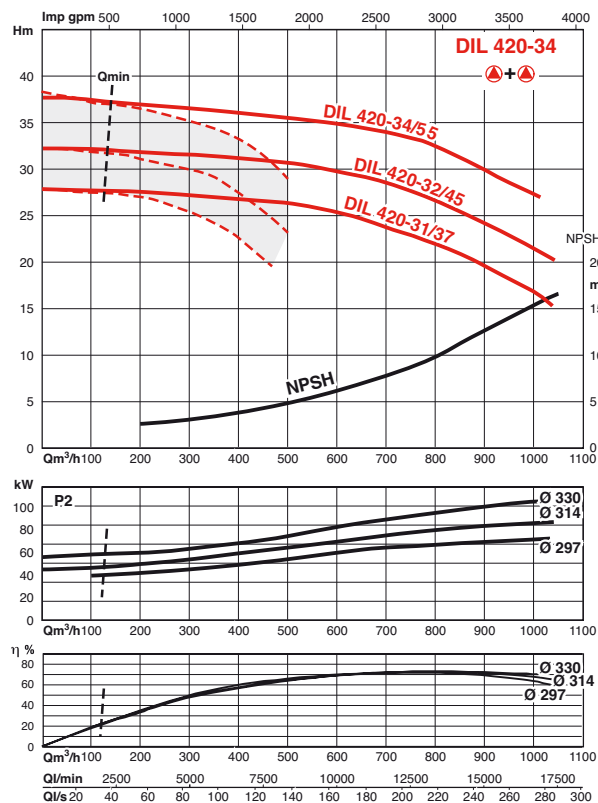
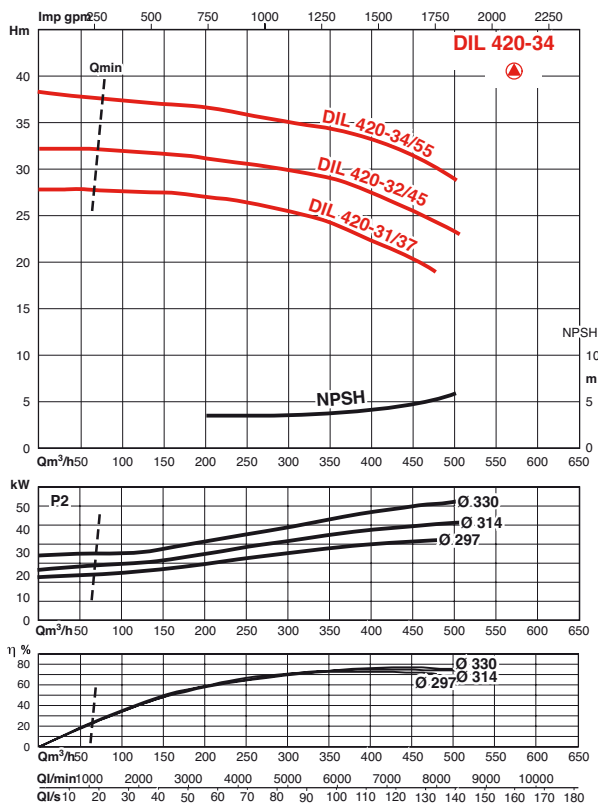

POSITIONS DE MONTAGE

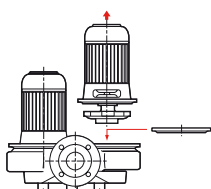

La position de montage avec l'arbre du moteur horizontal est autorisée jusqu'à une puissance nominale de 15 kW.

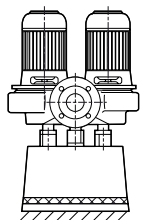

La position de montage "moteur vers le bas" est proscrite.
*Ne pas monter de vanne papillon directement sur la bride de refoulement pour ne pas gêner le fonctionnement du clapet.



SCHÉMA DE BRANCHEMENT



PARTICULARITÉS

a) Alimentation

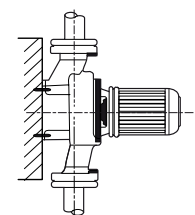
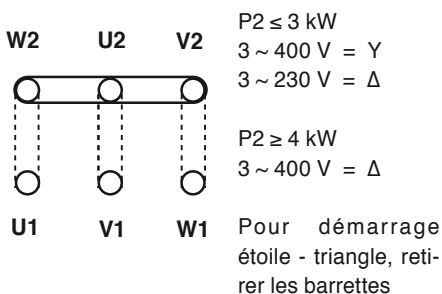
$P2 \leq 3 \text{ kW}$: triphasé 400 V Y 50 Hz
 triphasé 230 V Δ 50 Hz
 $P2 \geq 4 \text{ kW}$: triphasé 400 V Δ 50 Hz.

b) Installation

Montage direct sur tuyauterie horizontale ou verticale ou sur massif. L'installation doit permettre une protection de la pompe contre les intempéries et le gel (pas d'exposition directe à la pluie ou au soleil).

c) Conditionnement

Pompe livrée avec joints de contre-brides.

d) Maintenance

- Réparation : voir pièces de rechange recommandées.

• Accessoires recommandés

- Contre-brides
- Kit de prise de pression
- Discontacteur de protection
- Vannes d'isolement
- Manchettes anti-vibratoires
- Clapets anti-retour
- Kit Pieds supports.

Garniture mécanique spéciale en option pour eau glycolée de 20 - 40% si température supérieure à 40°C (nous consulter).

PERFORMANCES HYDRAULIQUES DIL 2 PÔLES

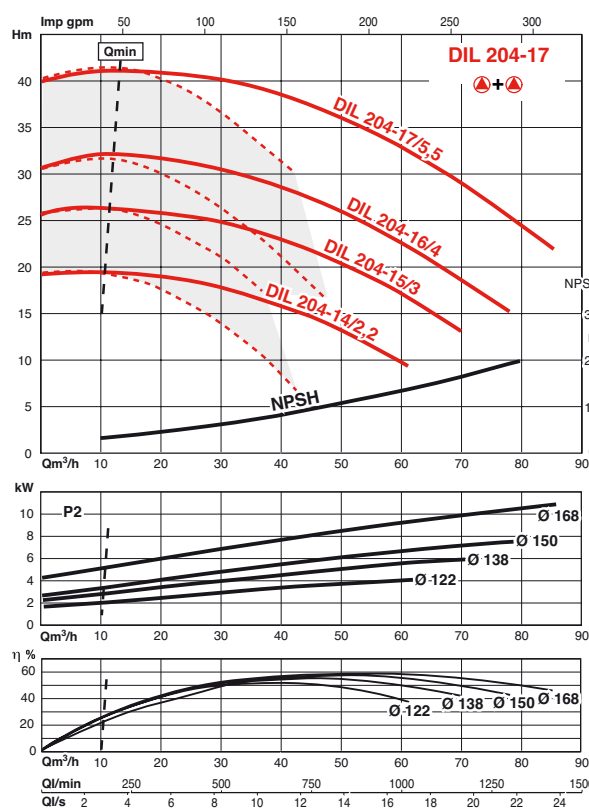
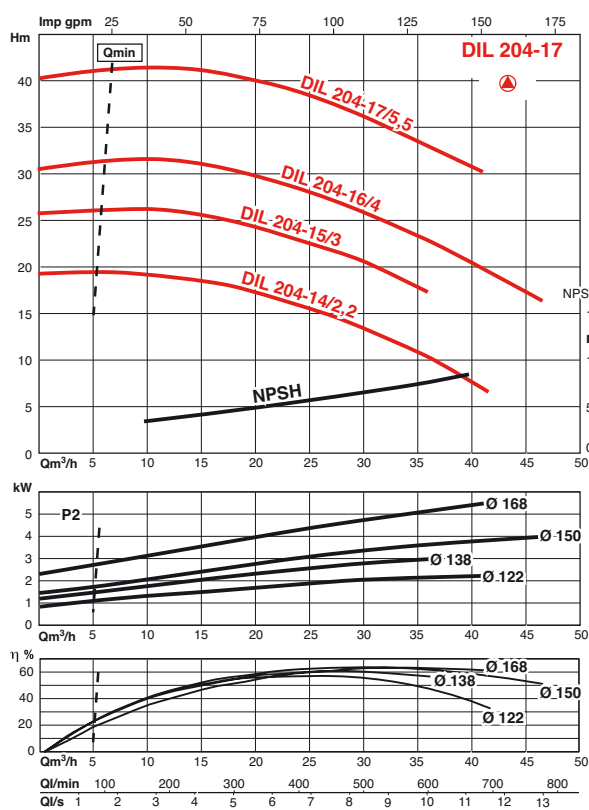
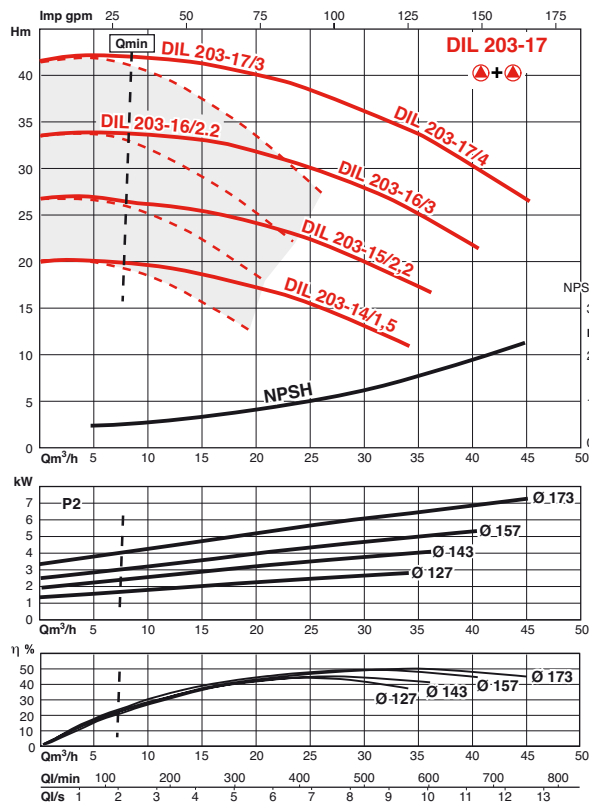
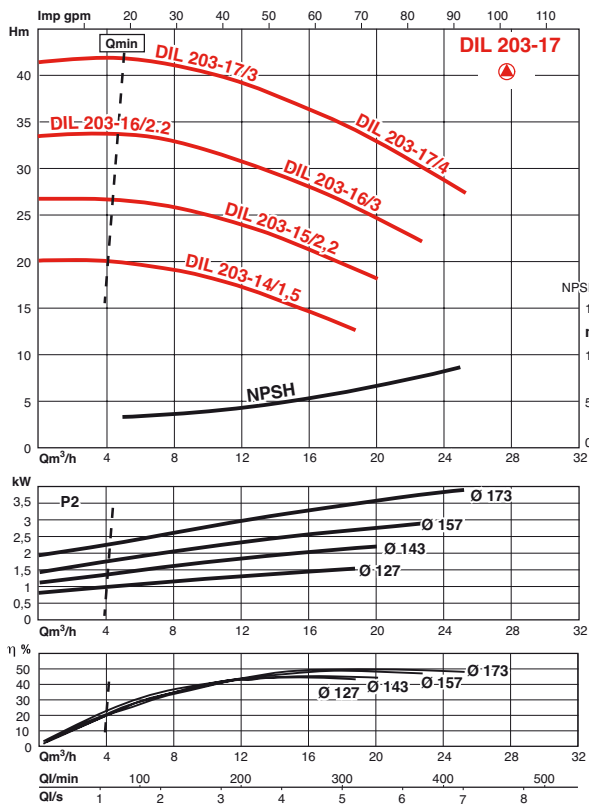

PERFORMANCES HYDRAULIQUES DIL 2 PÔLES

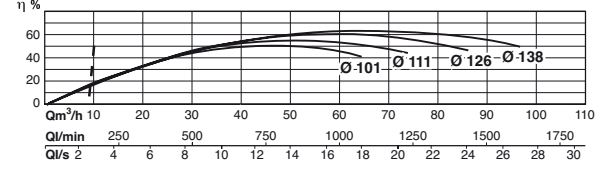
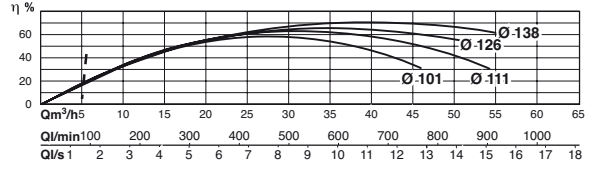
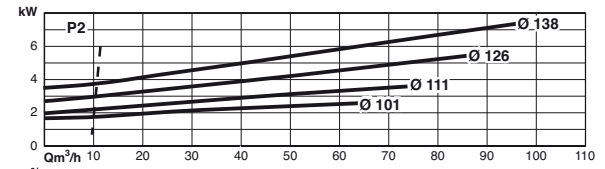
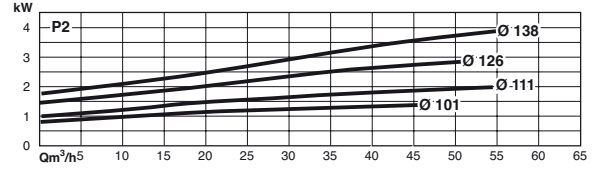
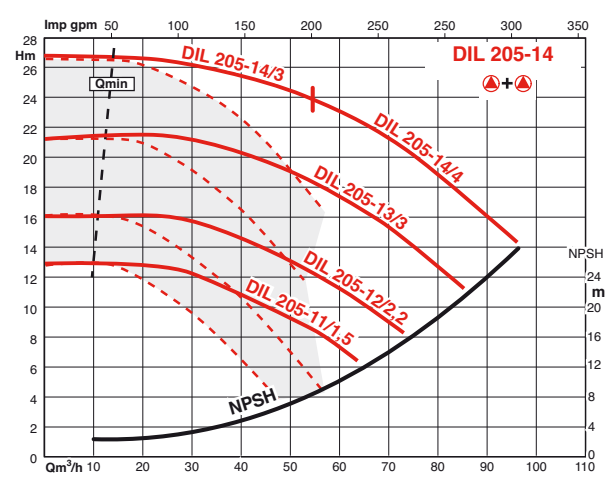
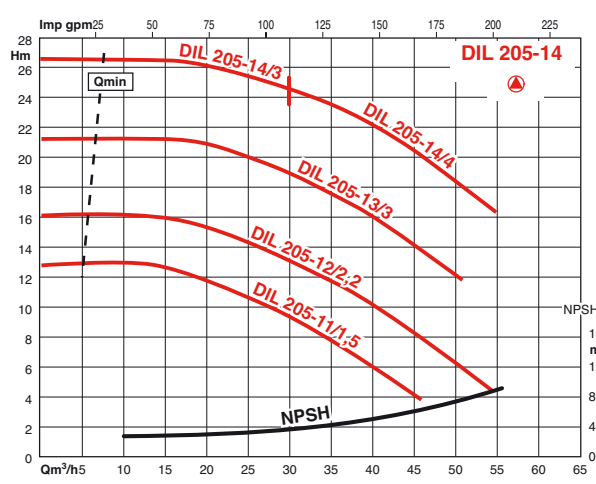
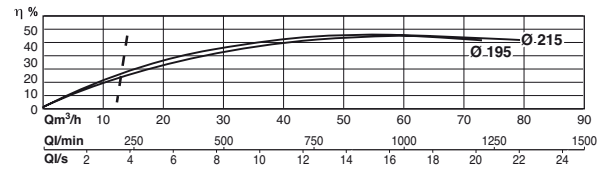
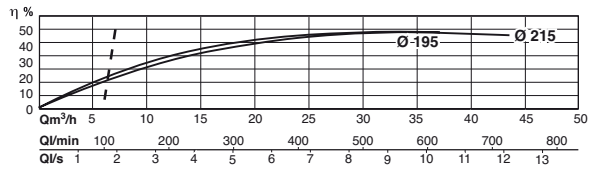
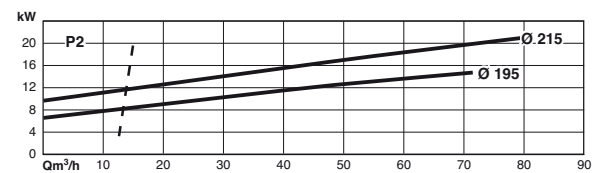
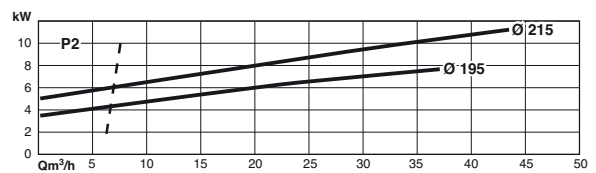
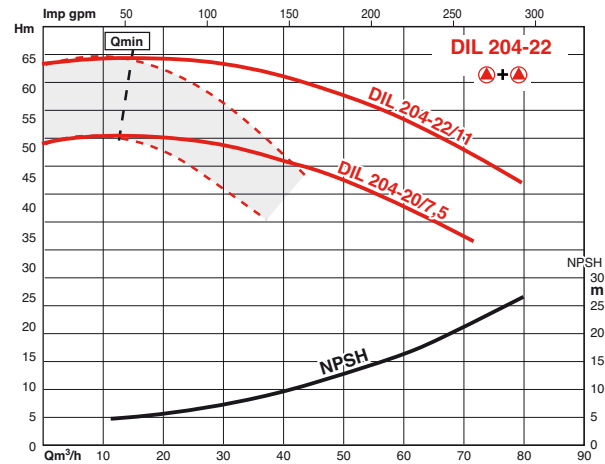
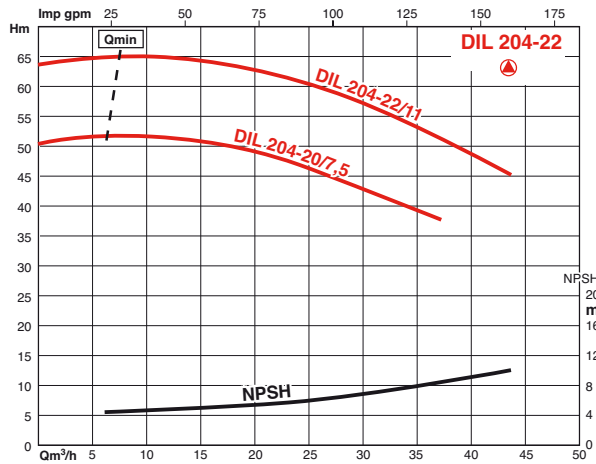

PERFORMANCES HYDRAULIQUES DIL 2 PÔLES

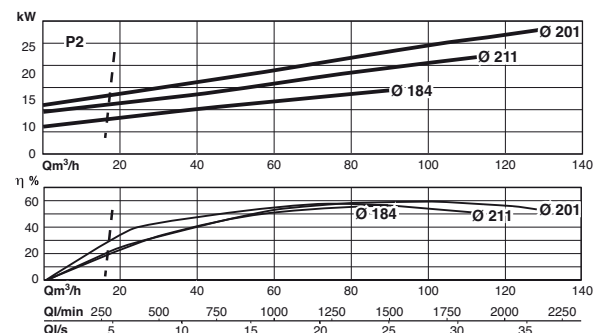
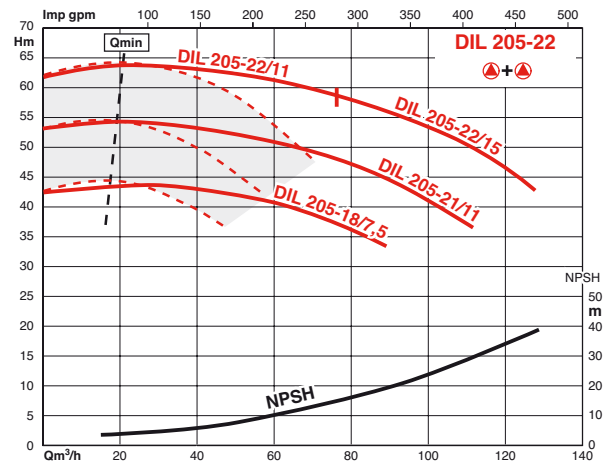
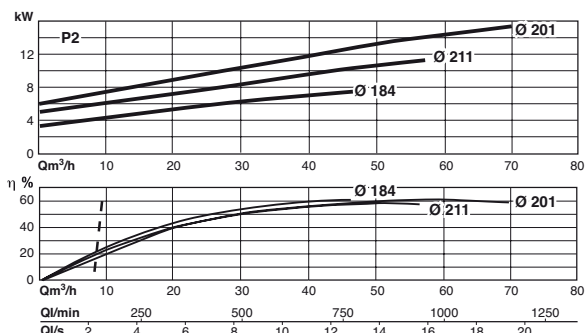
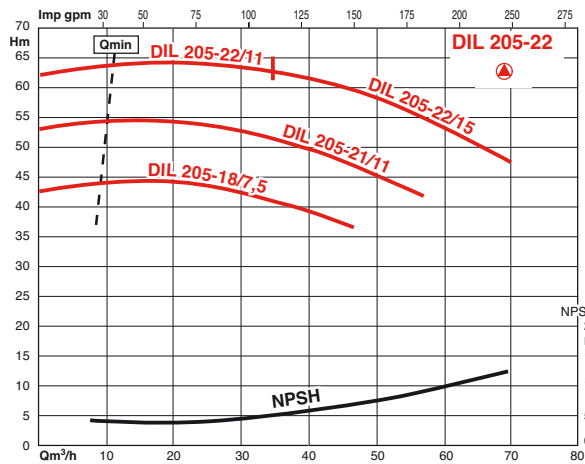
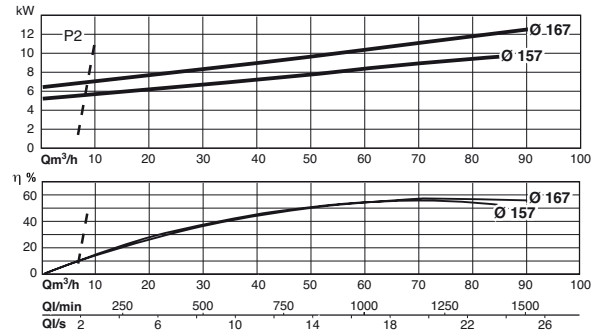
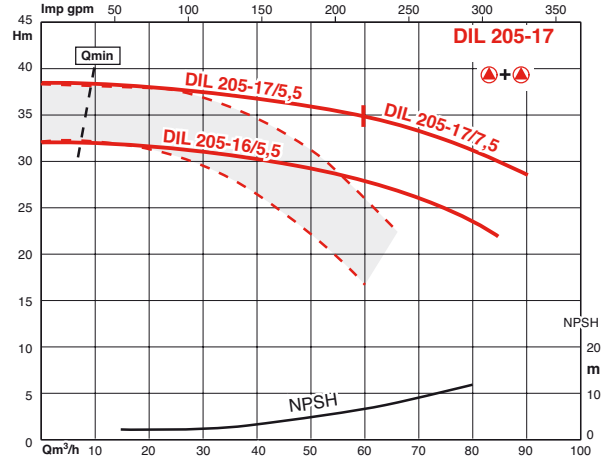
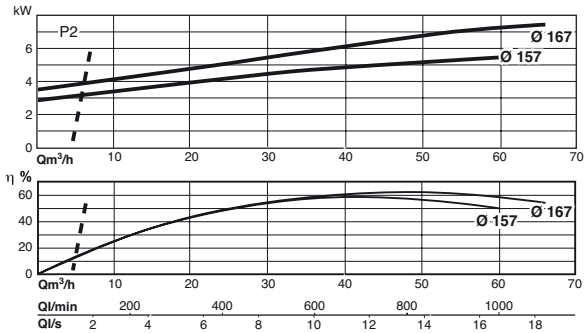
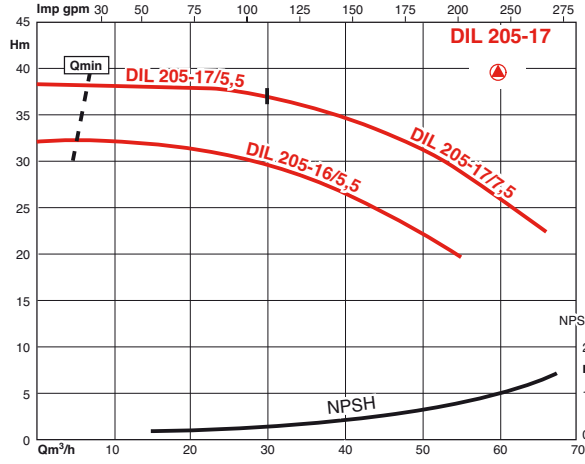

PERFORMANCES HYDRAULIQUES DIL 2 PÔLES

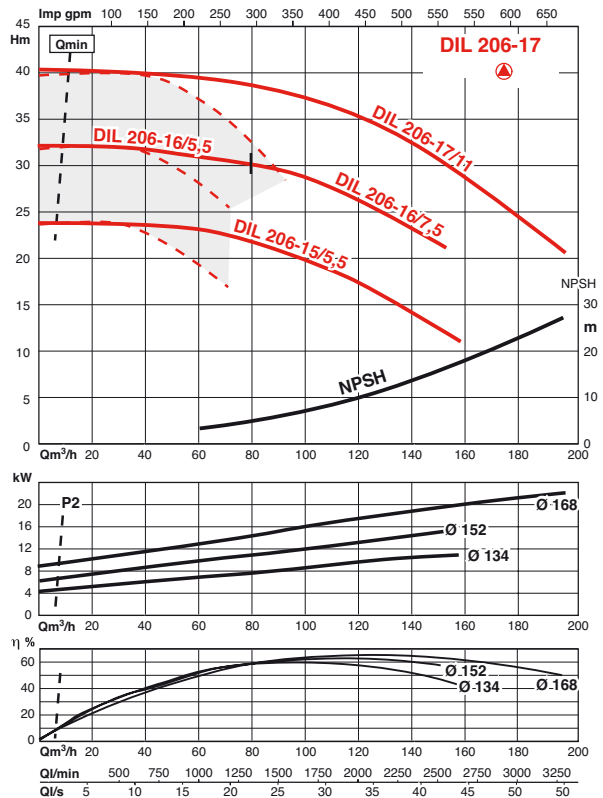
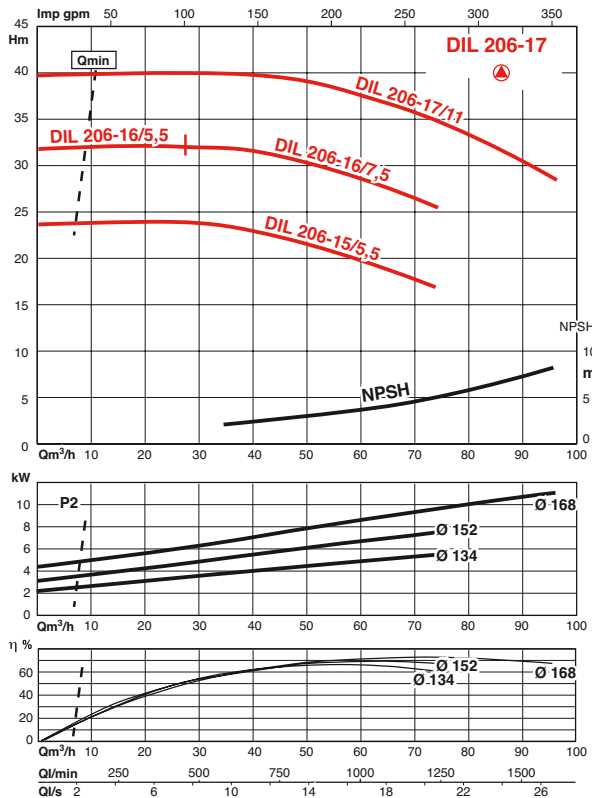
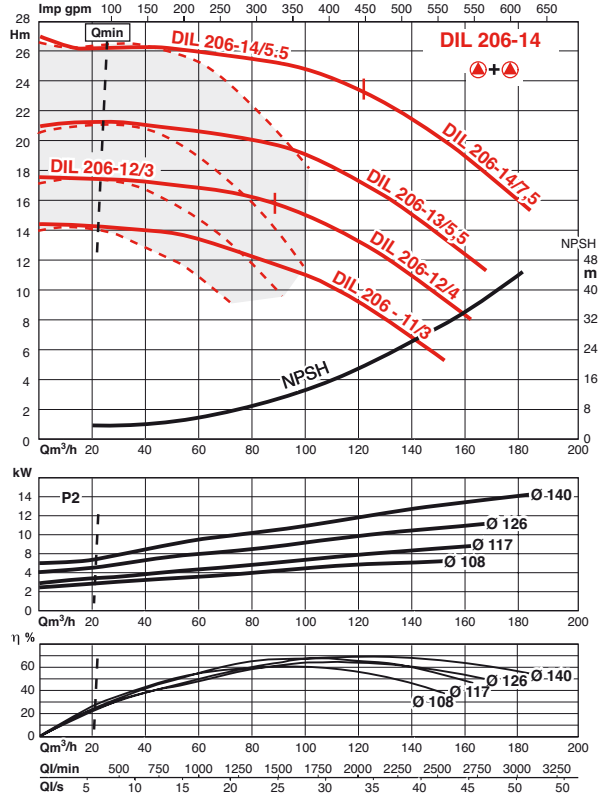
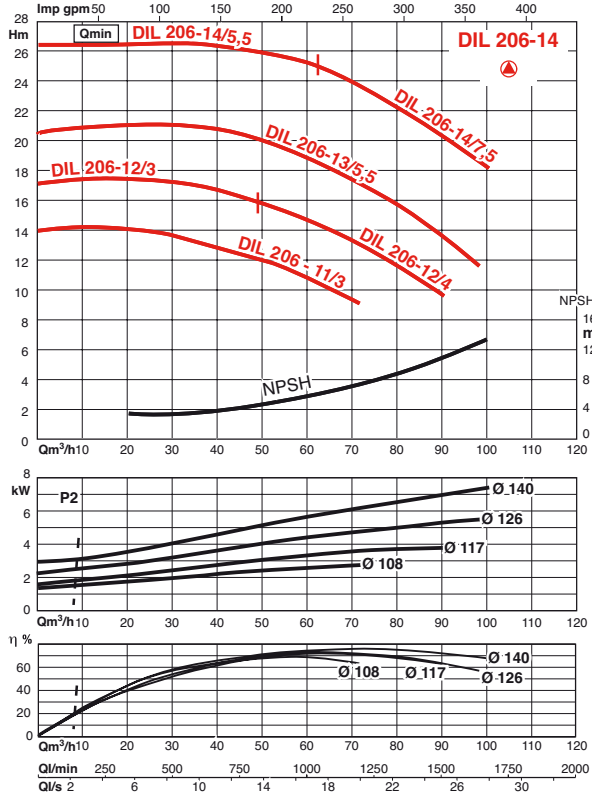

PERFORMANCES HYDRAULIQUES DIL 2 PÔLES

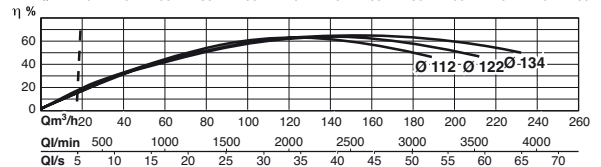
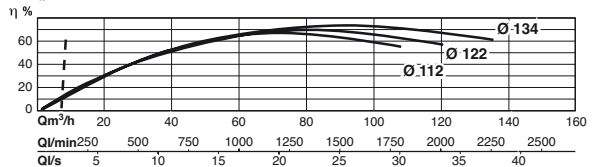
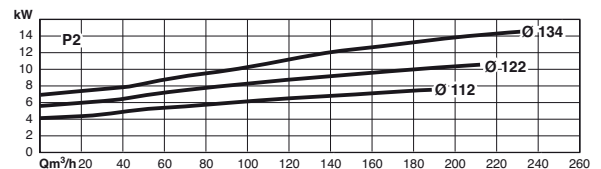
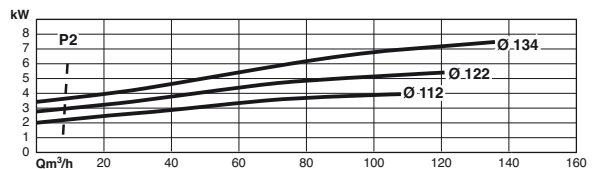
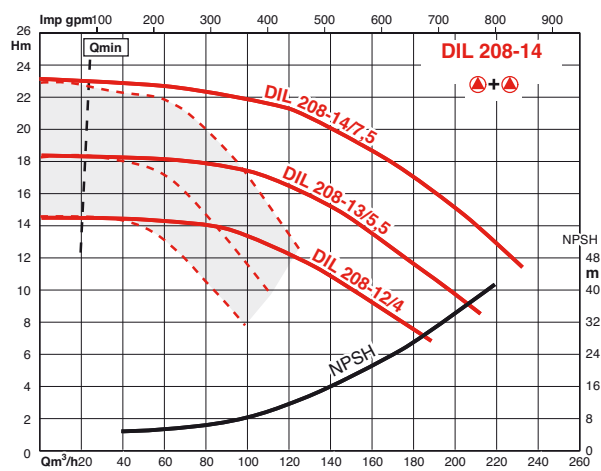
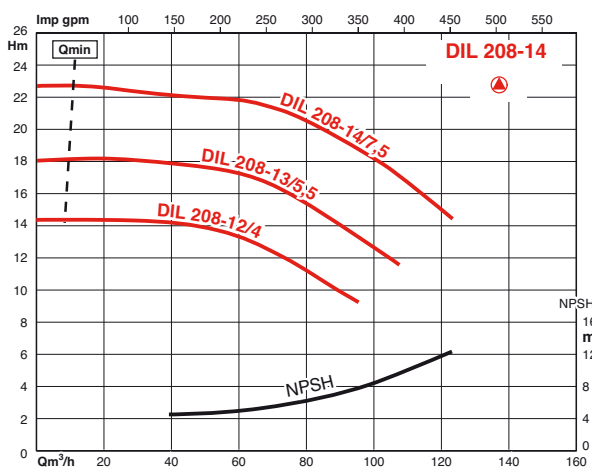
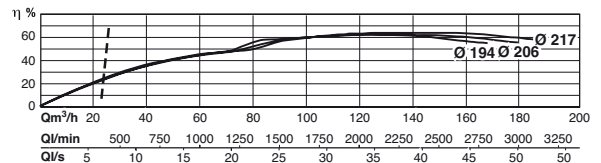
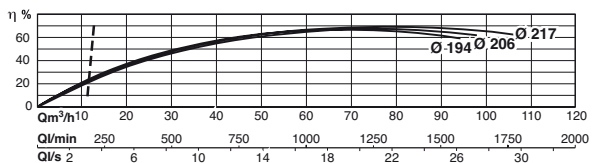
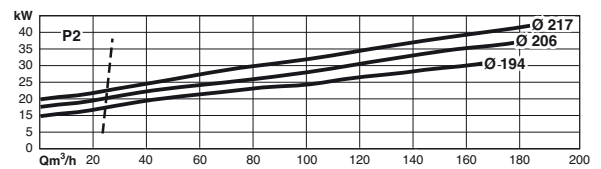
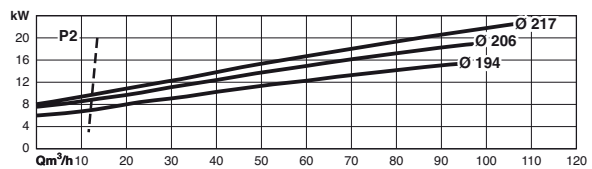
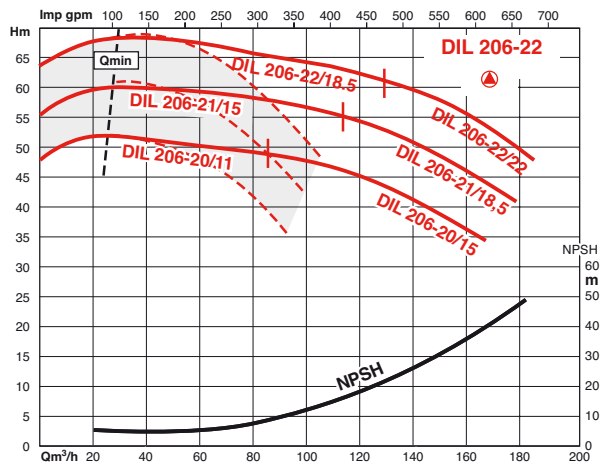
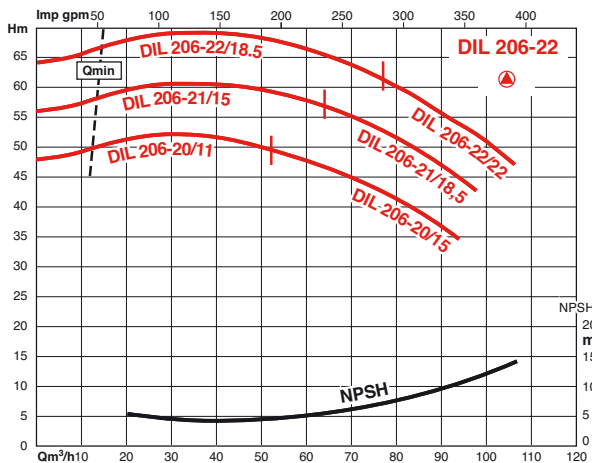

PERFORMANCES HYDRAULIQUES DIL 2 PÔLES

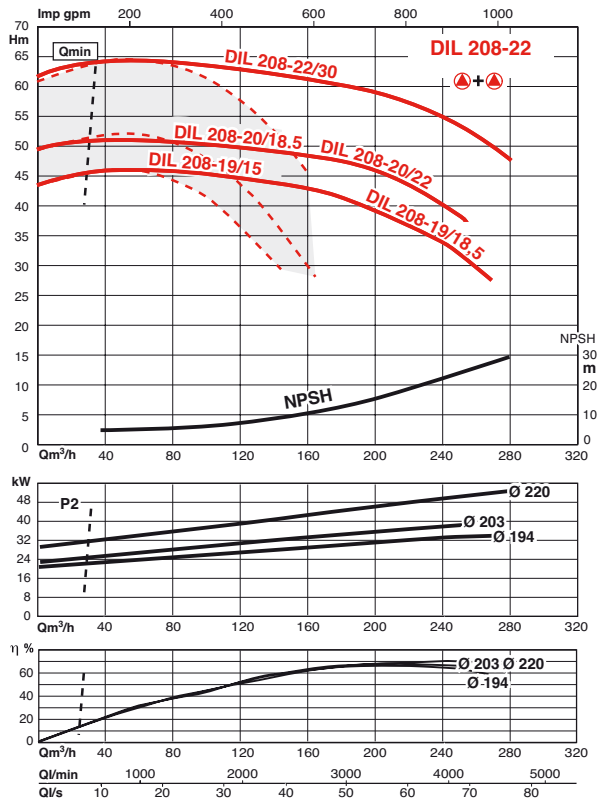
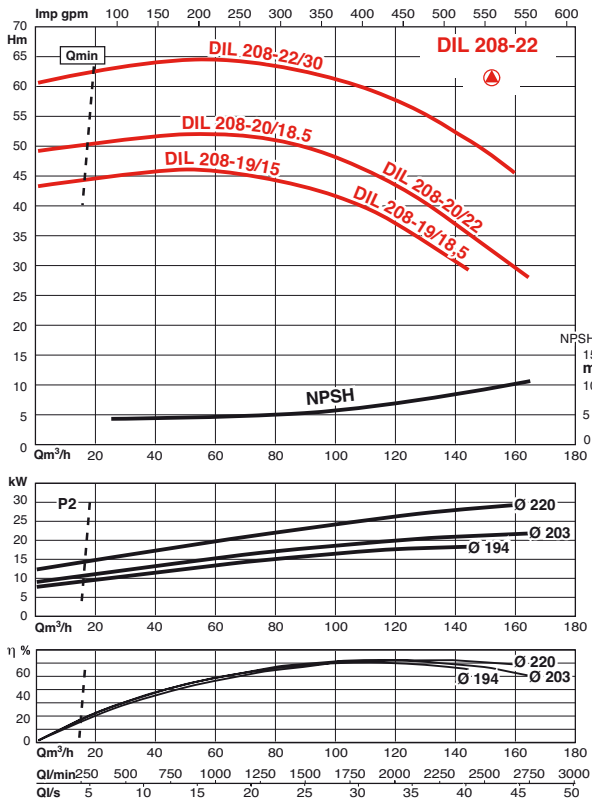
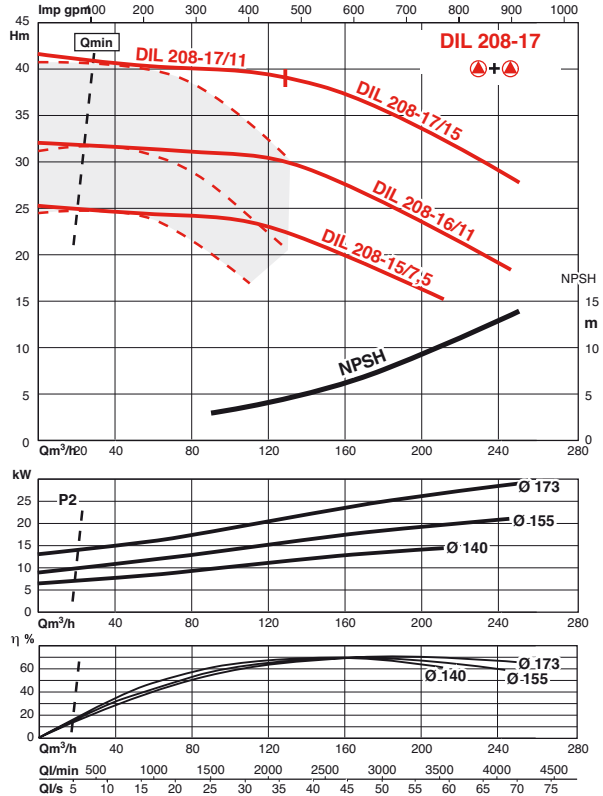
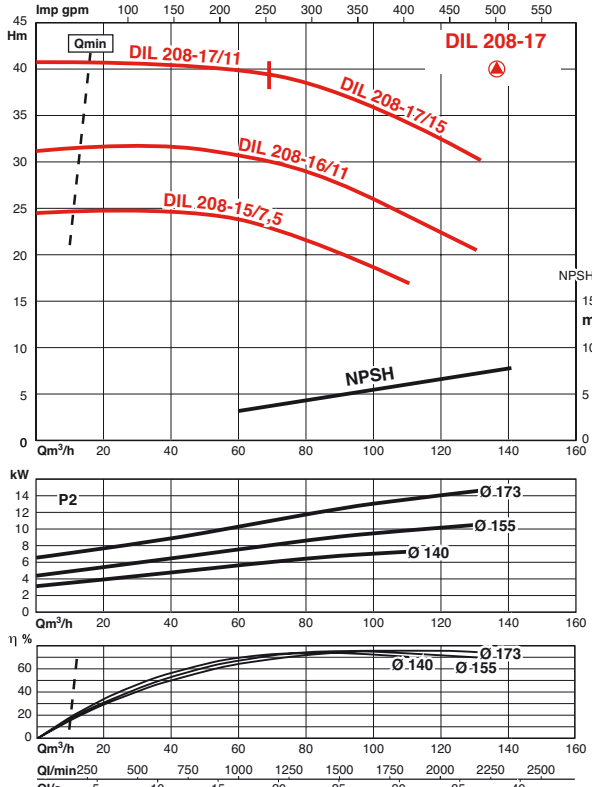

PERFORMANCES HYDRAULIQUES DIL 2 PÔLES

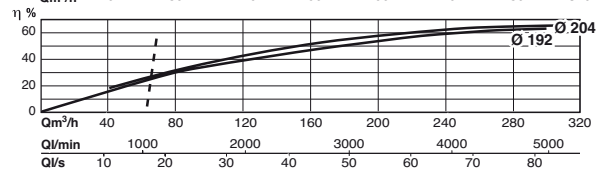
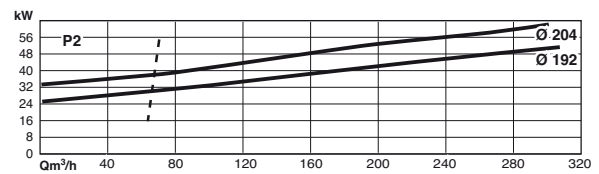
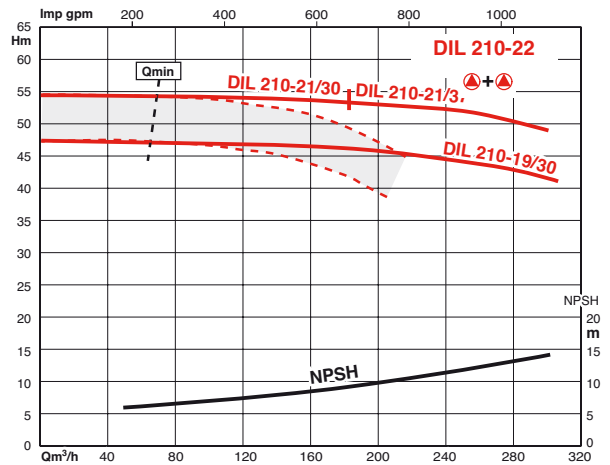
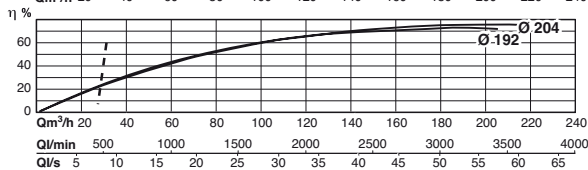
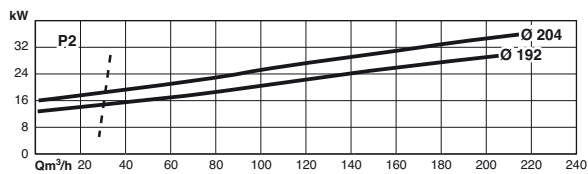
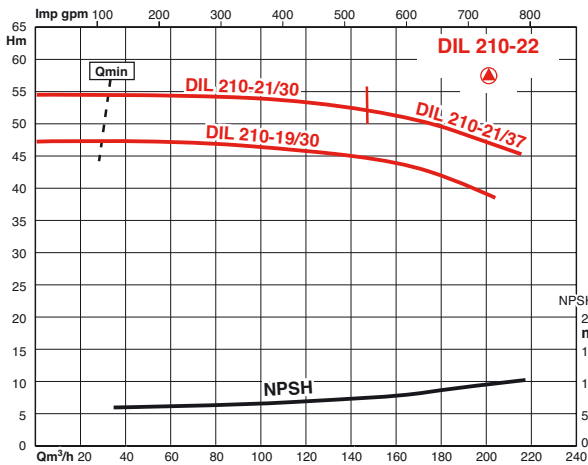
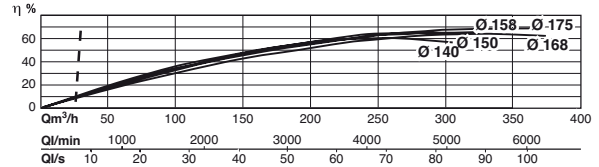
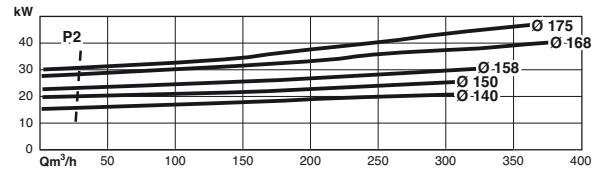
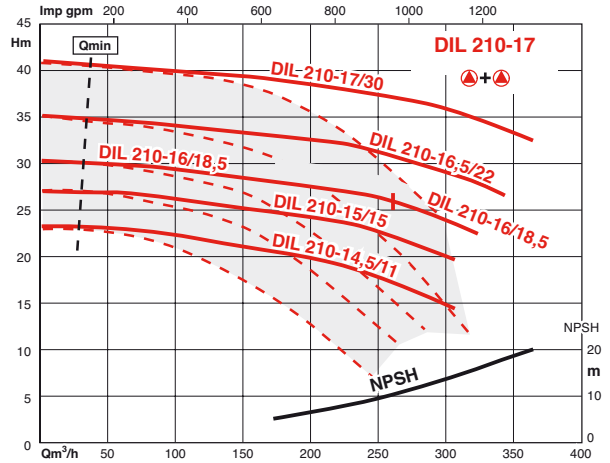
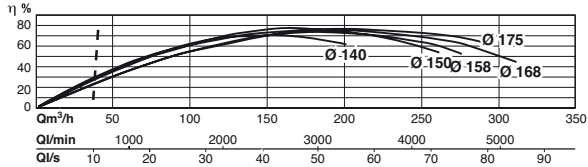
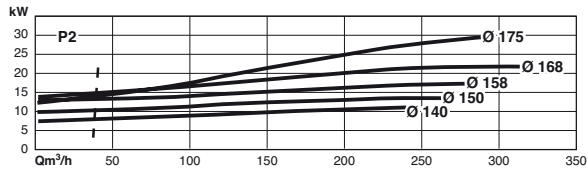
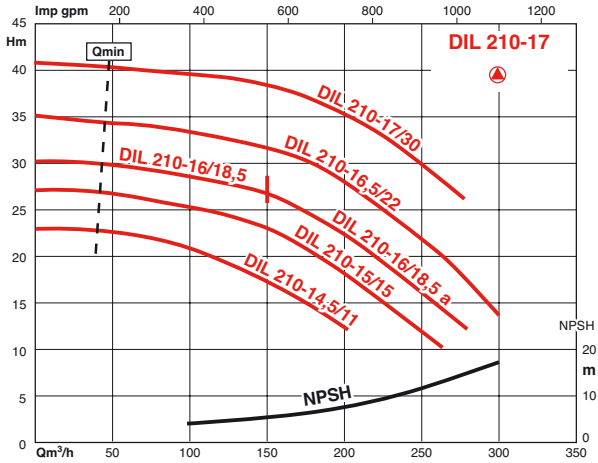

CARACTÉRISTIQUES ÉLECTRIQUES ET DIMENSIONNELLES A 1450 TR/MN

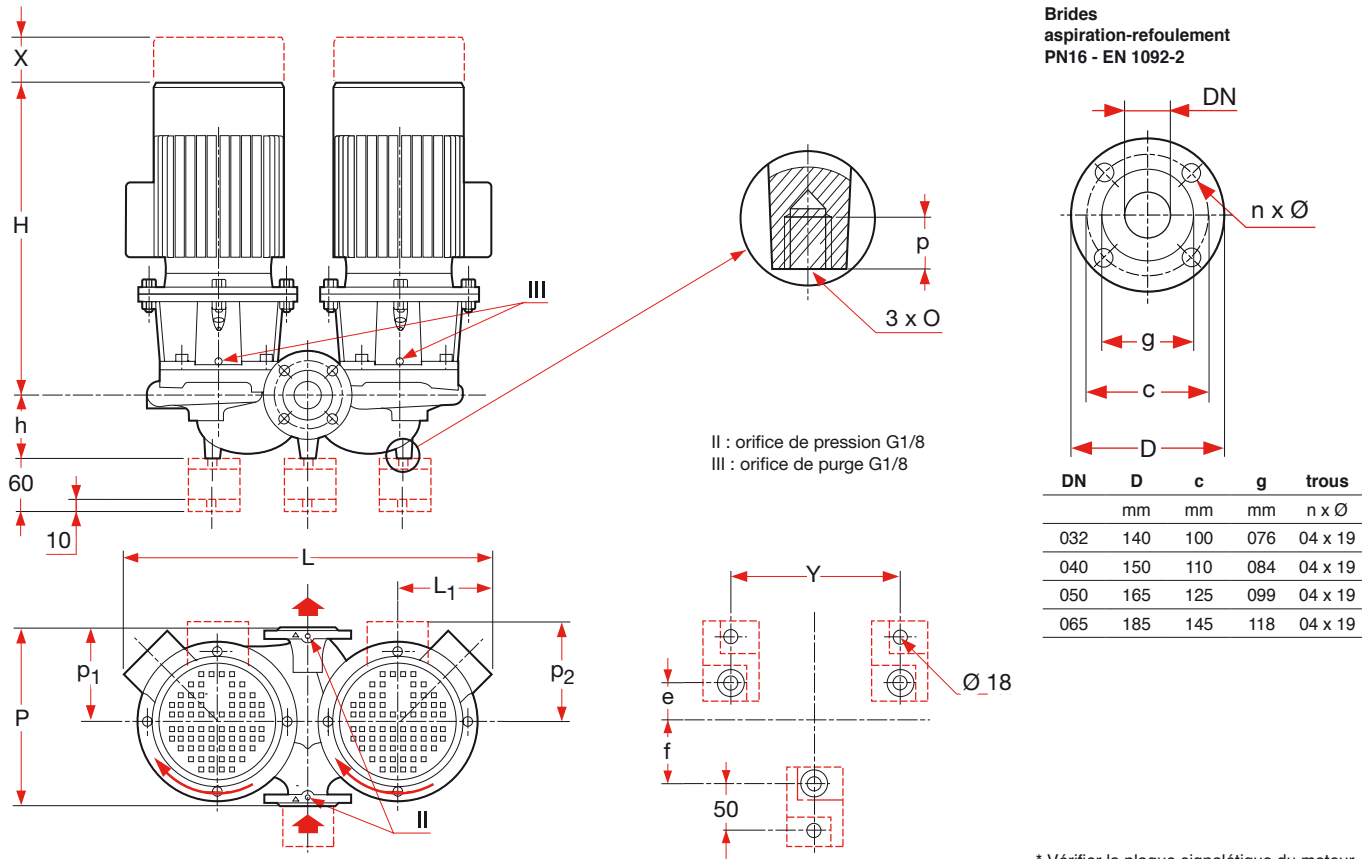

* Vérifier la plaque signalétique du moteur pour le réglage du thermique de protection

RÉFÉRENCE COMMANDE	MOTEUR			POMPE														
	P2 kW	intensité en A	Cos φ	DN orifices	h mm	L1 mm	L mm	Y mm	e mm	f mm	P mm	H mm	P1 mm	O mm	p mm	P2 mm	X mm	masse kg
DIL403-14/0.25	0.25	0.76	0.79	32	100	105	539	360	43	137	320	385	155	M10	20	-	90	77
DIL403-15/0.37	0.37	1.03	0.80	32	100	105	539	360	43	137	320	385	155	M10	20	-	90	80
DIL403-17/0.55	0.55	1.45	0.82	32	100	111	539	360	43	137	320	405	155	M10	20	-	90	84
DIL404-14/0.25	0.25	0.76	0.79	40	100	105	587	400	52	145	340	389	170	M10	20	-	95	82
DIL404-15/0.37	0.37	1.03	0.80	40	100	105	587	400	52	145	340	389	170	M10	20	-	95	84
DIL404-16/0.55	0.55	1.45	0.82	40	100	111	587	400	52	145	340	409	170	M10	20	-	95	88
DIL404-17/0.75	0.75	1.86	0.81	40	100	111	587	400	52	145	340	409	170	M10	20	-	95	90
DIL404-21/1.1	1.1	2.55	0.81	40	110	-	692	500	38	192	440	451	220	M10	20	128	100	111
DIL404-22/1.5	1.5	3.4	0.81	40	110	-	692	500	38	192	440	451	220	M10	20	128	100	118
DIL405-15/0.55	0.55	1.45	0.82	50	120	111	602	360	50	130	340	405	180	M10	20	-	100	92
DIL405-16/0.75	0.75	1.86	0.81	50	120	111	602	360	50	130	340	405	180	M10	20	-	100	95
DIL405-17/1.1	1.1	2.55	0.81	50	120	117	602	360	50	130	340	447	180	M10	20	-	100	102
DIL405-20/1.5	1.5	3.4	0.81	50	120	-	693	500	50	200	440	457	220	M10	20	128	100	115
DIL405-22/2.2	2.2	4.7	0.82	50	120	-	693	500	50	200	440	514	220	M10	20	135	100	134
DIL405-26/3	3	6.4	0.82	50	122	-	751	480	50	200	440	540	220	M10	20	135	120	158
DIL405-27/3	3	6.4	0.82	50	122	-	751	480	50	200	440	540	220	M10	20	135	120	158
DIL405-27/4	4	8.2	0.83	50	122	-	751	480	50	200	440	620	220	M10	20	148	120	172
DIL406-15/0.75	0.75	1.86	0.81	65	153	111	678	440	55	185	430	423	215	M12	20	-	120	114
DIL406-16/1.1	1.1	2.55	0.81	65	153	117	678	440	55	185	430	465	215	M12	20	-	120	121
DIL406-17/1.1	1.1	2.55	0.81	65	153	117	678	440	55	185	430	465	215	M12	20	-	120	122
DIL406-17/1.5	1.5	3.4	0.81	65	153	117	678	440	55	185	430	465	215	M12	20	-	120	128
DIL406-21/2.2	2.2	4.7	0.82	65	140	-	723	520	45	210	475	523	245	M12	20	135	110	145
DIL406-22/2.2	2.2	4.7	0.82	65	140	-	723	520	45	210	475	523	245	M12	20	135	110	145
DIL406-22/3	3	6.4	0.82	65	140	-	723	520	45	210	475	523	245	M12	20	135	110	151
DIL406-25/3	3	6.4	0.82	65	140	-	760	500	50	220	475	543	235	M12	20	135	120	168
DIL406-25/4	4	8.2	0.83	65	140	-	760	500	50	220	475	623	235	M12	20	148	120	180
DIL406-27/5.5	5.5	11.4	0.81	65	140	-	760	500	50	220	475	694	235	M12	20	167	120	204

CARACTÉRISTIQUES ÉLECTRIQUES ET DIMENSIONNELLES A 1450 TR/MN

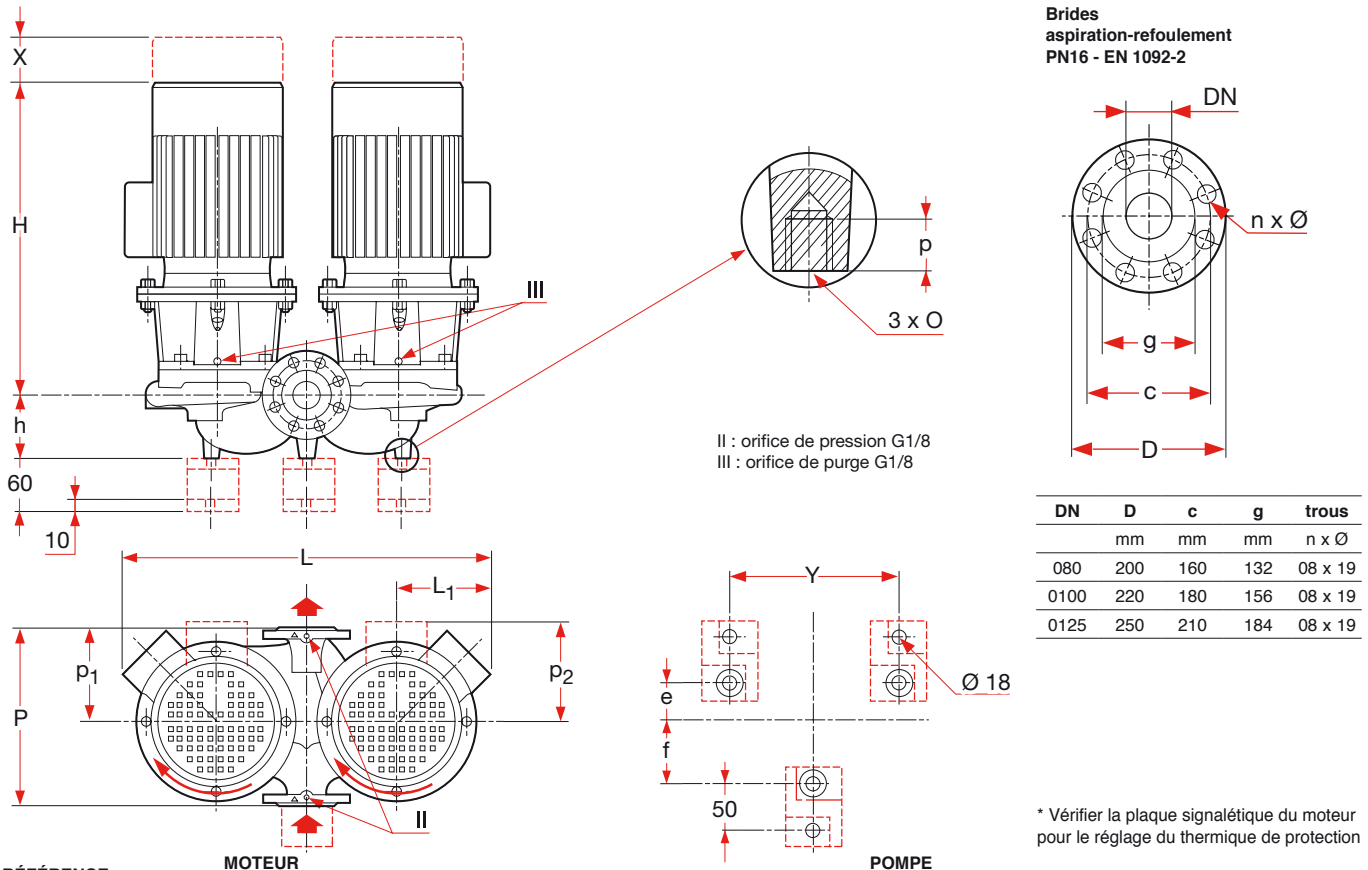

DN	D	c	g	trous
	mm	mm	mm	n x Ø
080	200	160	132	08 x 19
0100	220	180	156	08 x 19
0125	250	210	184	08 x 19

RÉFÉRENCE COMMANDE	MOTEUR			DN	h	L1	L	Y	e	f	P	H	P1	O	p	P2	X	masse
	P2	intensité nominale	Cos φ															
DIL408-15/1.1	1.1	2.55	0.81	80	155	117	704	440	62	188	440	470	220	M12	20	-	120	133
DIL408-16/1.5	1.5	3.4	0.81	80	155	117	704	440	62	188	440	470	220	M12	20	-	120	140
DIL408-17/2.2	2.2	4.7	0.82	80	155	138	704	440	62	188	440	525	220	M12	20	-	120	162
DIL408-21/3	3	6.4	0.82	80	145	-	792	550	72	228	500	528	250	M12	20	135	120	169
DIL408-22/4	4	8.2	0.83	80	145	-	792	550	72	228	500	608	250	M12	20	148	120	181
DIL408-27/5.5	5.5	11.4	0.81	80	125	168	836	560	62	233	500	682	245	M12	20	167	115	234
DIL410-14.5/1.1	1.1	2.55	0.81	100	180	117	801	580	80	250	500	484	226	M12	20	-	135	154
DIL410-15/1.5	1.5	3.4	0.81	100	180	117	801	580	80	250	500	484	226	M12	20	-	135	161
DIL410-16/2.2	2.2	4.7	0.82	100	180	138	801	580	80	250	500	538	226	M12	20	-	135	183
DIL410-17/3	3	6.4	0.82	100	180	138	801	580	80	250	500	538	226	M12	20	-	135	188
DIL410-20/3	3	6.4	0.82	100	155	-	830	560	79	251	550	536	275	M12	20	135	120	188
DIL410-20/4	4	8.2	0.83	100	155	-	830	560	79	251	550	616	275	M12	20	148	120	200
DIL410-22/5.5	5.5	11.4	0.81	100	155	-	830	560	79	251	550	687	275	M12	20	167	120	228
DIL410-25/5.5	5.5	11.4	0.81	100	180	-	888	560	62	233	550	692	260	M12	20	167	120	263
DIL410-25/7.5	7.5	15.2	0.82	100	180	-	888	600	54	266	550	692	260	M12	20	167	120	275
DIL410-26/11	11	21.5	0.84	100	180	-	888	600	54	266	550	843	260	M12	20	197	120	346
DIL410-27/11	11	21.5	0.84	100	180	-	888	600	54	266	550	843	260	M12	20	197	120	346
DIL412-19/4	4	8.2	0.83	125	179,5	-	894	640	67,5	282,5	620	635	311,5	M16	25	148	120	225
DIL412-21/5.5	5.5	11.4	0.81	125	179,5	-	894	640	67,5	282,5	620	706	311,5	M16	25	167	120	257
DIL412-22/5.5	5.5	11.4	0.81	125	179,5	-	894	640	67,5	282,5	620	706	311,5	M16	25	167	120	257
DIL412-22/7.5	7.5	15.2	0.82	125	179,5	-	894	640	67,5	282,5	620	706	311,5	M16	25	167	120	273
DIL412-25/11	11	21.5	0.84	125	200	-	1042	591	86	314	620	856	280	M16	25	197	130	397
DIL412-27/11	11	21.5	0.84	125	200	-	1042	591	86	314	620	856	280	M16	25	197	130	397
DIL412-27/15	15	28.5	0.84	125	200	-	1042	591	86	314	620	856	280	M16	25	197	130	421
DIL412-30/18.5	18.5	35	0.83	125	200	-	1119	800	51	334	700	924	340	M16	25	259	140	615
DIL412-32/18.5	18.5	35	0.83	125	200	-	1119	800	51	334	700	924	340	M16	25	259	140	615
DIL412-32/22	22	41	0.84	125	200	-	1119	800	51	334	700	952	340	M16	25	259	140	635
DIL412-34/30	30	55	0.86	125	200	-	1119	800	51	334	700	1012	340	M16	25	306	140	729

* Vérifier la plaque signalétique du moteur pour le réglage du thermique de protection

CARACTÉRISTIQUES ÉLECTRIQUES ET DIMENSIONNELLES A 1450 TR/MN

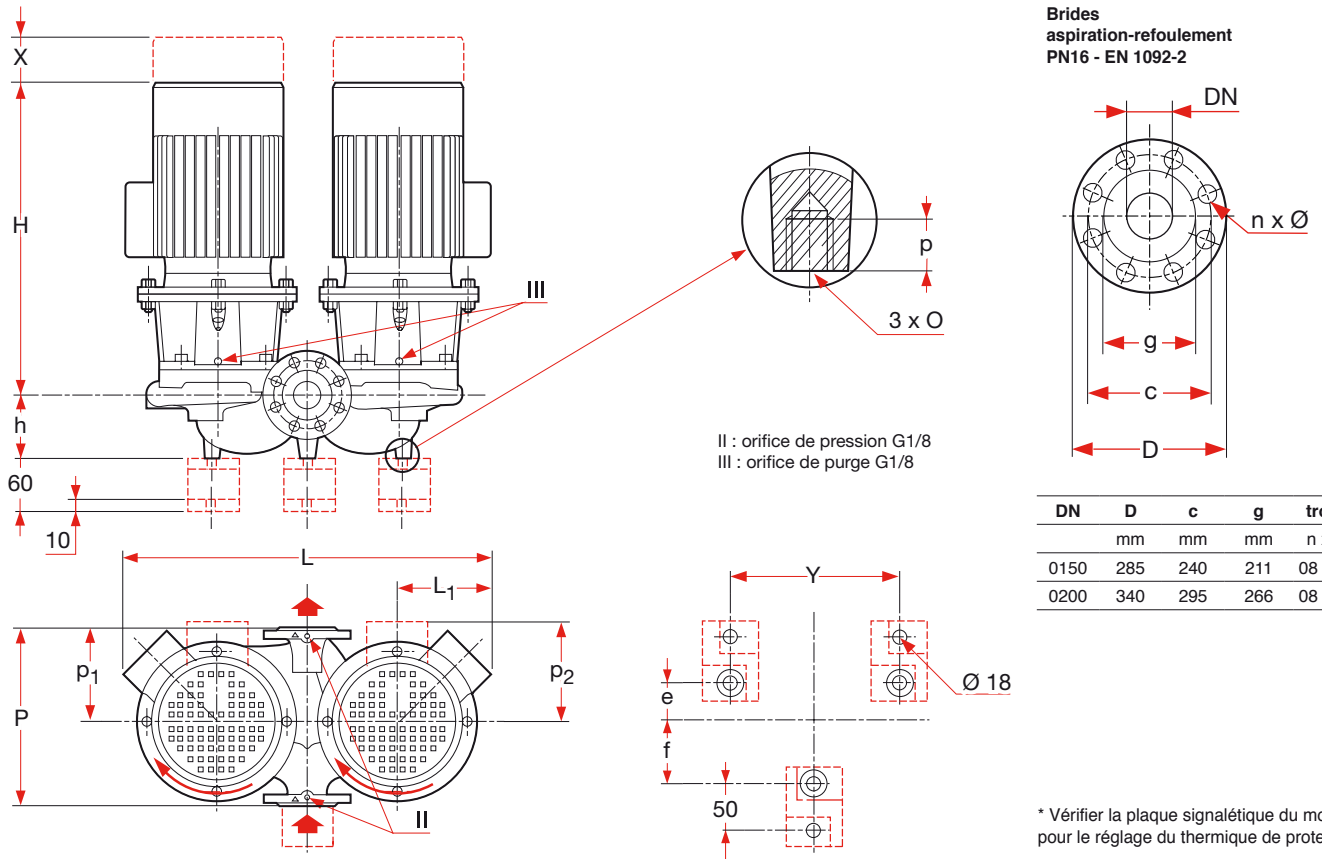

RÉFÉRENCE COMMANDE	MOTEUR			POMPE														
	P2	intensité nominale		DN	h	L1	L	Y	e	f	P	H	P1	O	p	P2	X	masse
	kW	en A	Cos φ	orifices	mm	mm	mm	mm	mm	mm	mm	mm	mm	mm	mm	mm	mm	kg
DIL415-19/5.5	5.5	11.4	0.81	150	210	-	1006	640	91	309	700	710	365	M16	25	167	130	324
DIL415-20/7.5	7.5	15.2	0.82	150	210	-	1006	640	91	309	700	710	365	M16	25	167	130	340
DIL415-22/11	11	21.5	0.84	150	210	-	1006	640	91	309	700	861	365	M16	25	197	130	409
DIL415-25/15	15	28.5	0.84	150	230	-	1203	696	116	344	700	887	330	M16	25	197	135	548
DIL415-26/15	15	28.5	0.84	150	230	-	1203	696	116	344	700	887	330	M16	25	197	135	548
DIL415-26/18.5	18.5	35	0.83	150	230	-	1203	696	116	344	700	929	330	M16	25	259	135	604
DIL415-27/18.5	18.5	35	0.83	150	230	-	1203	696	116	344	700	929	330	M16	25	259	135	604
DIL415-27/22	22	41	0.84	150	230	-	1203	696	116	344	700	957	330	M16	25	259	135	624
DIL415-30/30	30	55	0.86	150	230	-	1293	758	130	374	770	1025	370	M16	25	306	145	639
DIL415-32/37	37	66	0.87	150	230	-	1293	758	130	374	770	1130	370	M16	25	306	145	748
DIL415-34/37	37	66	0.87	150	230	-	1293	758	130	374	770	1130	370	M16	25	306	145	748
DIL415-34/45	45	80	0.87	150	230	-	1293	758	130	374	770	1130	370	M16	25	306	145	800
DIL420-24/15	15	28.5	0.84	200	250	-	1369	1000	62	400	800	912	370	M16	25	197	140	688
DIL420-25/18.5	18.5	35	0.83	200	250	-	1369	1000	62	400	800	954	370	M16	25	259	140	745
DIL420-26/22	22	41	0.84	200	250	-	1369	1000	62	400	800	982	370	M16	25	259	140	765
DIL420-27/30	30	55	0.86	200	250	-	1369	1000	62	400	800	1042	370	M16	25	306	140	856
DIL420-31/37	37	66	0.87	200	245	-	1400	808	129	391	820	1155	400	M16	25	306	155	1000
DIL420-32/45	45	80	0.87	200	245	-	1400	808	129	391	820	1155	400	M16	25	306	155	1051
DIL420-34/55	55	100	0.85	200	245	-	1400	808	129	391	820	1250	400	M16	25	430	155	1359

CARACTÉRISTIQUES ÉLECTRIQUES ET DIMENSIONNELLES A 2900 TR/MN

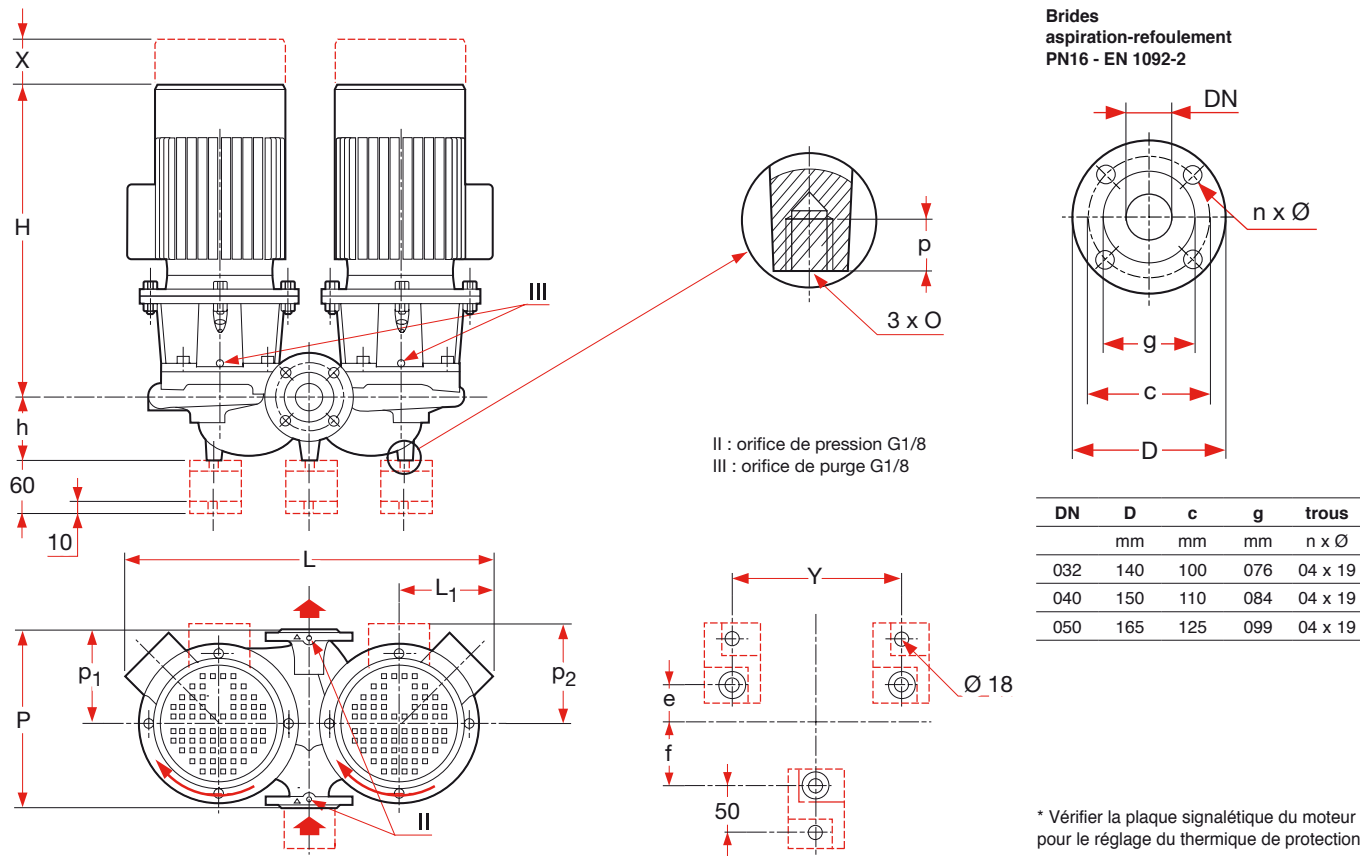

RÉFÉRENCE COMMANDE	MOTEUR			POMPE														
	P2	intensité nominale		DN	h	L1	L	Y	e	f	P	H	P1	O	p	P2	X	masse
	kW	en A	Cos φ	orifices	mm	mm	mm	mm	mm	mm	mm	mm	mm	mm	mm	mm	mm	kg
DIL203-14/1.5	1.5	3.3	0.85	32	100	117	539	360	43	137	320	445	155	M10	20	-	90	94
DIL203-15/2.2	2.2	4.6	0.85	32	100	117	539	360	43	137	320	445	155	M10	20	-	90	99
DIL203-16/2.2	2.2	4.6	0.85	32	100	117	539	360	43	137	320	445	155	M10	20	-	90	99
DIL203-16/3	3	6.1	0.85	32	100	138	576	360	43	137	320	501	155	M10	20	-	90	118
DIL203-17/3	3	6.1	0.85	32	100	138	576	360	43	137	320	501	155	M10	20	-	90	118
DIL203-17/4	4	7.8	0.86	32	100	147	594	360	43	137	320	581	155	M10	20	-	90	132
DIL204-14/2.2	2.2	4.6	0.85	40	100	117	587	400	52	145	340	449	170	M10	20	-	95	104
DIL204-15/3	3	6.1	0.85	40	100	138	616	400	52	145	340	505	170	M10	20	-	95	123
DIL204-16/4	4	7.8	0.86	40	100	147	634	400	52	145	340	585	170	M10	20	-	95	137
DIL204-17/5.5	5.5	10.3	0.89	40	100	168	676	400	52	145	340	646	170	M10	20	-	95	159
DIL204-20/7.5	7.5	13.8	0.89	40	110	-	700	500	38	192	440	659	220	M10	20	167	100	200
DIL204-22/11	11	20	0.88	40	110	-	750	500	38	192	440	810	220	M10	20	197	100	258
DIL205-11/1.5	1.5	3.3	0.85	50	105	117	534	360	52	148	340	448	170	M10	20	-	100	87
DIL205-12/2.2	2.2	4.6	0.85	50	105	117	534	360	52	148	340	448	170	M10	20	-	100	92
DIL205-13/3	3	6.1	0.85	50	105	138	576	360	52	148	340	508	170	M10	20	-	100	116
DIL205-14/3	3	6.1	0.85	50	105	138	576	360	52	148	340	508	170	M10	20	-	100	116
DIL205-14/4	4	7.8	0.86	50	105	147	594	360	52	148	340	588	170	M10	20	-	100	130
DIL205-16/5.5	5.5	10.3	0.89	50	120	168	676	360	50	130	340	643	180	M10	20	-	100	168
DIL205-17/5.5	5.5	10.3	0.89	50	120	168	676	360	50	130	340	643	180	M10	20	-	100	168
DIL205-17/7.5	7.5	13.8	0.89	50	120	168	676	360	50	130	340	643	180	M10	20	-	100	189
DIL205-18/7.5	7.5	13.8	0.89	50	120	-	700	500	50	200	440	665	220	M10	20	167	100	197
DIL205-21/11	11	20	0.88	50	120	-	750	500	50	200	440	816	220	M10	20	197	100	255
DIL205-22/11	11	20	0.88	50	120	-	750	500	50	200	440	816	220	M10	20	197	100	255
DIL205-22/15	15	26.5	0.90	50	120	-	750	500	50	200	440	816	220	M10	20	197	100	278

CARACTÉRISTIQUES ÉLECTRIQUES ET DIMENSIONNELLES A 2900 TR/MN

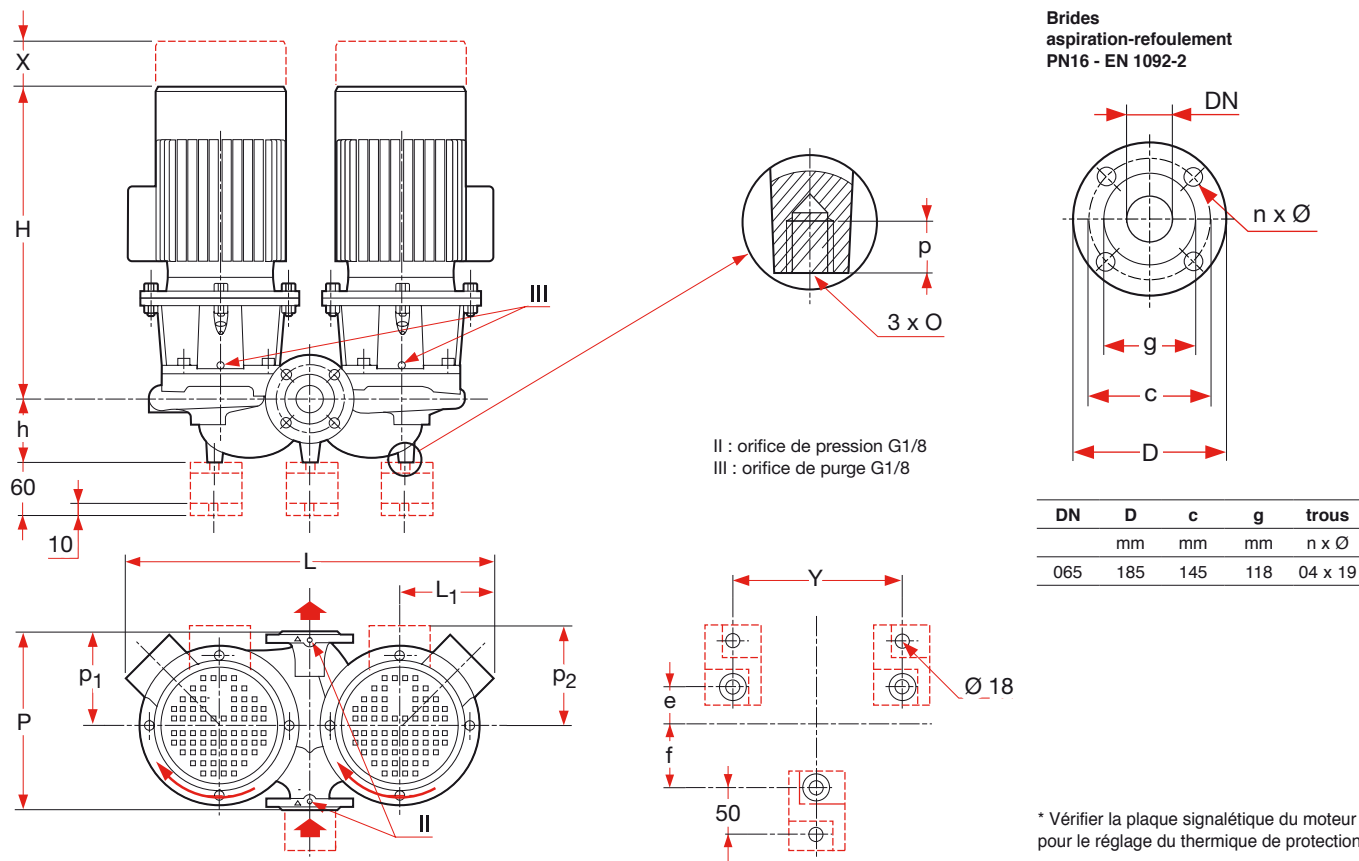

RÉFÉRENCE COMMANDE	MOTEUR			POMPE														
	P2 kW	intensité nominale en A	Cos φ	DN orifices	h mm	L1 mm	L mm	Y mm	e mm	f mm	P mm	H mm	P1 mm	O mm	p mm	P2 mm	X mm	masse kg
DIL206-11/3	3	6.1	0.85	65	120	138	616	400	50	150	340	512	170	M12	20	-	110	129
DIL206-12/3	3	6.1	0.85	65	120	138	616	400	50	150	340	512	170	M12	20	-	110	129
DIL206-12/4	4	7.8	0.86	65	120	147	634	400	50	150	340	592	170	M12	20	-	110	143
DIL206-13/5.5	5.5	10.3	0.89	65	120	-	640	400	50	150	340	659	170	M12	20	167	110	166
DIL206-14/5.5	5.5	10.3	0.89	65	120	-	640	400	50	150	340	659	170	M12	20	167	110	166
DIL206-14/7.5	7.5	13.8	0.89	65	120	-	640	400	50	150	340	659	170	M12	20	167	110	182
DIL206-15/5.5	5.5	10.3	0.89	65	153	168	736	440	55	185	430	662	215	M12	20	-	120	188
DIL206-16/5.5	5.5	10.3	0.89	65	153	168	736	440	55	185	430	662	215	M12	20	-	120	189
DIL206-16/7.5	7.5	13.8	0.89	65	153	168	736	440	55	185	430	662	215	M12	20	-	120	207
DIL206-17/11	11	20	0.88	65	153	-	750	440	55	185	430	821	215	M12	20	197	120	257
DIL206-20/11	11	20	0.88	65	140	-	750	520	45	210	475	826	245	M12	20	197	110	267
DIL206-20/15	15	26.5	0.90	65	140	-	750	520	45	210	475	826	245	M12	20	197	110	289
DIL206-21/15	15	26.5	0.90	65	140	-	750	520	45	210	475	826	245	M12	20	197	110	289
DIL206-21/18.5	18.5	32.5	0.91	65	140	-	750	520	45	210	475	826	245	M12	20	197	110	315
DIL206-22/18.5	18.5	32.5	0.91	65	140	-	750	520	45	210	475	826	245	M12	20	197	110	315
DIL206-22/22	22	39	0.88	65	140	-	758	520	45	210	475	866	245	M12	20	259	110	360

CARACTÉRISTIQUES ÉLECTRIQUES ET DIMENSIONNELLES A 2900 TR/MN

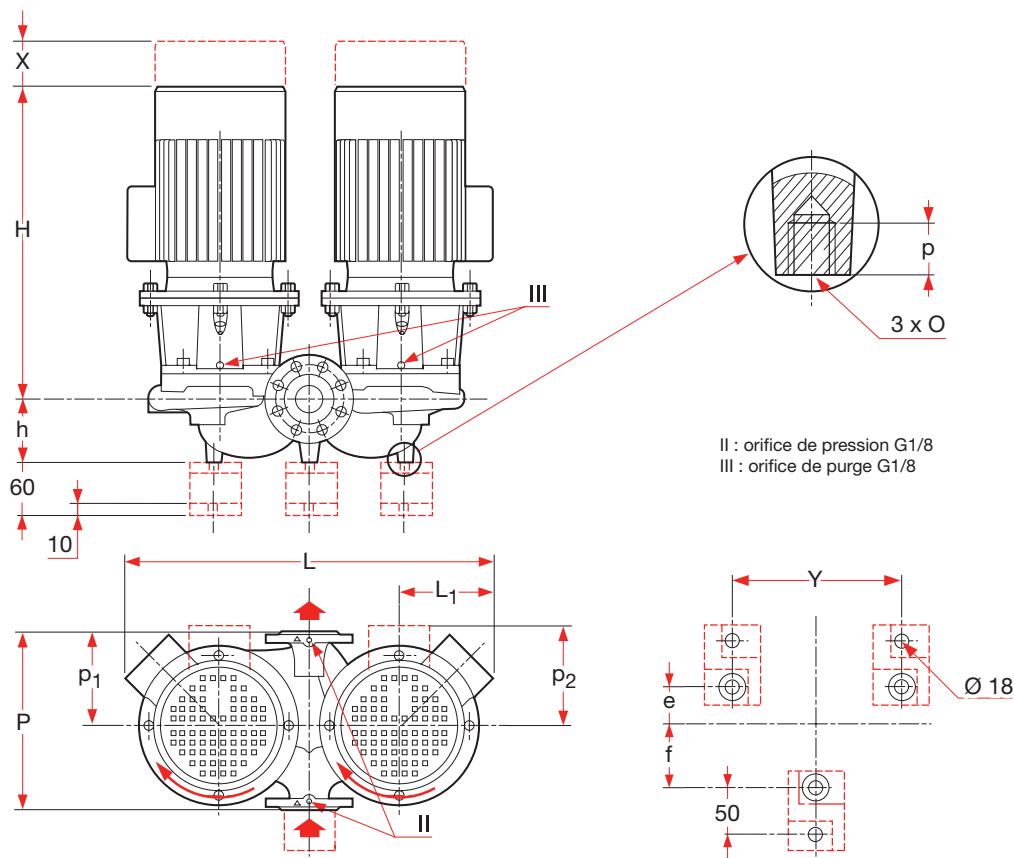

Brides
aspiration-refoulement
PN16 - EN 1092-2

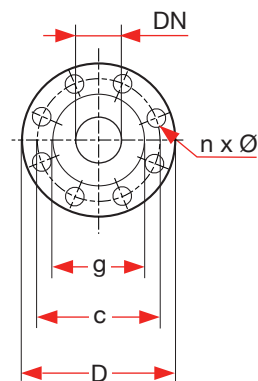

DN	D	c	g	trous
	mm	mm	mm	n x Ø
080	200	160	132	08 x 19
0100	220	180	156	08 x 19
0125	250	210	184	08 x 19

* Vérifier la plaque signalétique du moteur pour le réglage du thermique de protection

RÉFÉRENCE COMMANDE	MOTEUR			POMPE														
	P2 kW	intensité nominale en A	Cos φ	DN orifices	h mm	L1 mm	L mm	Y mm	e mm	f mm	P mm	H mm	P1 mm	O mm	p mm	P2 mm	X mm	masse kg
DIL208-12/4	4	7.8	0.86	80	155	147	644	400	62	178	400	600	200	M12	20	-	120	157
DIL208-13/5.5	5.5	10.3	0.89	80	155	-	650	400	62	178	400	667	200	M12	20	167	120	180
DIL208-14/7.5	7.5	13.8	0.89	80	155	-	650	400	62	178	400	667	200	M12	20	167	120	196
DIL208-15/7.5	7.5	13.8	0.89	80	155	168	736	440	62	188	440	666	220	M12	20	-	120	218
DIL208-16/11	11	20	0.88	80	155	-	750	440	62	188	440	826	220	M12	20	197	120	267
DIL208-17/11	11	20	0.88	80	155	-	750	440	62	188	440	826	220	M12	20	197	120	267
DIL208-17/15	15	26.5	0.90	80	155	-	750	440	62	188	440	826	220	M12	20	197	120	294
DIL208-19/15	15	26.5	0.90	80	145	-	801	550	72	228	500	830	250	M12	20	197	120	307
DIL208-19/18.5	18.5	32.5	0.91	80	145	-	801	550	72	228	500	830	250	M12	20	197	120	333
DIL208-20/18.5	18.5	32.5	0.91	80	145	-	801	550	72	228	500	830	250	M12	20	197	120	333
DIL208-20/22	22	39	0.88	80	145	-	808	550	72	228	500	870	250	M12	20	259	120	378
DIL208-22/30	30	53	0.89	80	145	-	850	550	72	228	500	960	250	M12	20	306	120	489
DIL210-14.5/11	11	20	0.88	100	180	-	803	580	80	250	500	839	226	M12	20	197	135	289
DIL210-15/15	15	26.5	0.90	100	180	-	803	580	80	250	500	839	226	M12	20	197	135	315
DIL210-16.5/22	22	39	0.88	100	180	-	807	580	80	250	500	881	226	M12	20	259	135	379
DIL210-16/15	15	26.5	0.90	100	180	-	803	580	80	250	500	839	226	M12	20	197	135	315
DIL210-16/18.5	18.5	32.5	0.91	100	180	-	803	580	80	250	500	839	226	M12	20	197	135	350
DIL210-17/30	30	53	0.89	100	180	-	840	580	80	250	500	969	226	M12	20	306	135	490
DIL210-19/30	30	53	0.89	100	155	-	850	560	79	251	550	969	275	M12	20	306	120	507
DIL210-21/30	30	53	0.89	100	155	-	850	560	79	251	550	969	275	M12	20	306	120	507
DIL210-21/37	37	65	0.89	100	155	-	850	560	79	251	550	969	275	M12	20	306	120	553