

motralec

4 rue Lavoisier . ZA Lavoisier . 95223 HERBLAY CEDEX

Tel. : 01.39.97.65.10 / Fax. : 01.39.97.68.48

Demande de prix / e-mail : service-commercial@motralec.com

www.motralec.com

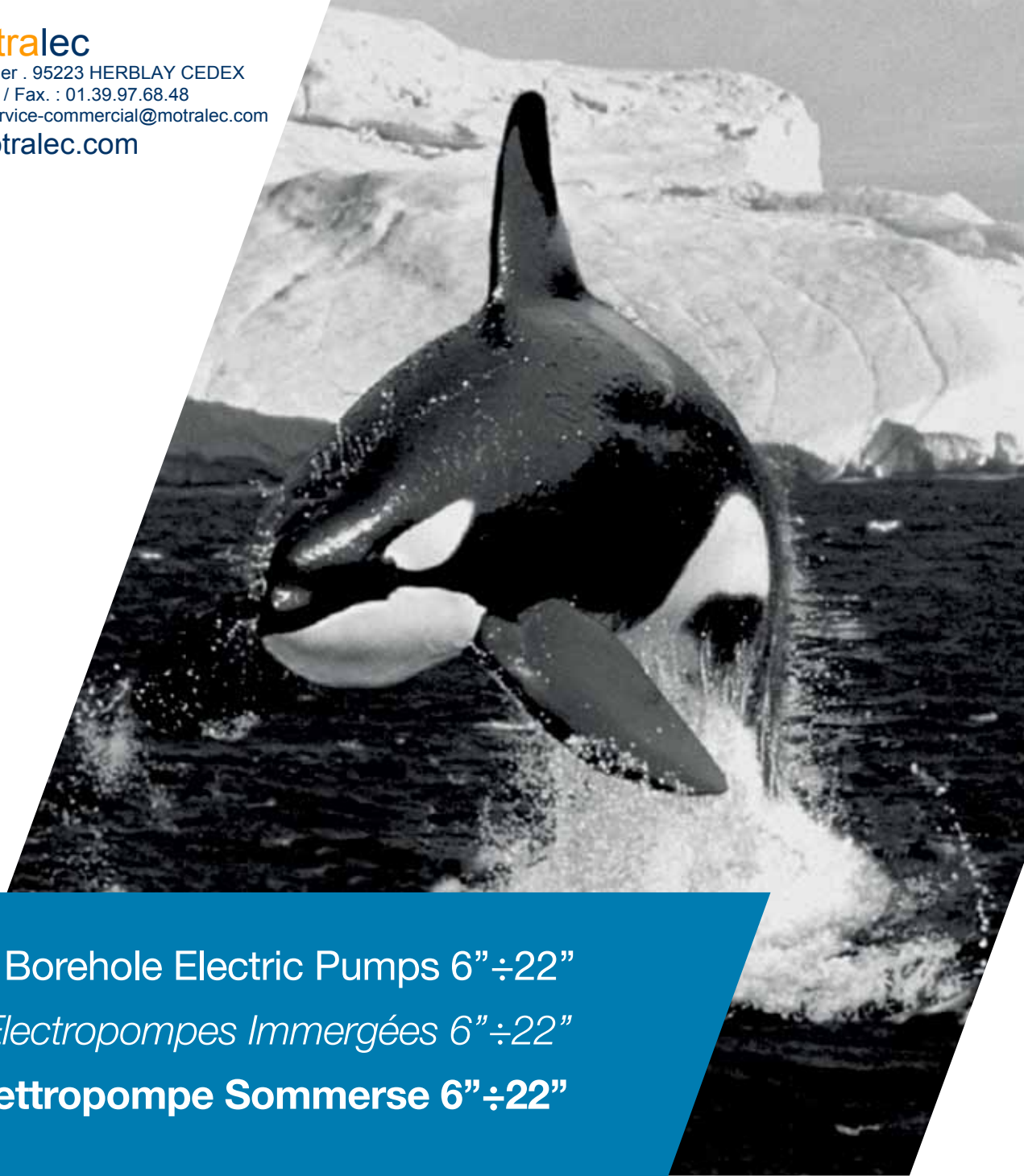

Borehole Electric Pumps 6" ÷ 22"
Electropompes Immergées 6" ÷ 22"
Elettropompe Sommerse 6" ÷ 22"

caprari
pumping power



A UNIQUE RANGE

More than 9.000 reliable solutions for a variety of demanding applications

- The widest range of product
- great versatility of use even under heavy duty conditions
- best in class efficiency and benchmark performance
- reliability and sturdiness

these are the main features of the E Series borehole electric pumps

- *Une gamme parmi les plus amples et les plus profondes*
- *grande polyvalence d'utilisation en conditions extrêmes*
- *rendements "best-in-class" et point de référence*
- *fiabilité et robustesse*

sont les caractéristiques des électropompes immergées série E

- **La gamma più ampia e profonda**
- **grande versatilità di impiego anche in condizioni estreme**
- **rendimenti best in class e prestazioni benchmark**
- **affidabilità e robustezza**

sono le caratteristiche delle elettropompe sommerse serie E





APPLICATIONS • APPLICATIONS • APPLICAZIONI

Aqueducts
Adduction d'eau

Acquedottistica

Civil and industrial water supply
Alimentation à usage civil et industriel

Approvvigionamento idrico civile ed industriale

Conditioning
Conditionnement

Condizionamento

Controlling the level of underground water tables
Contrôle du niveau des nappes d'eau souterraines

Contenimento del livello delle falde acquifere sotterranee

Urban water features
Mobilier urbain

Arredo urbano

Industry
Industrie

Industria

Artificial snow-covering
Enneigement artificiel

Innevamento artificiale

Fire fighting
Anti-incendie

Antincendio

Systems for greenhouses, gardening and leisure uses
Installations pour serres, jardins et le secteur des loisirs

Impianti per serre, giardinaggio e per il tempo libero

Irrigation and Reclamation systems
Irrigation et Traitement

Irrigazione e Bonifica

Desalination
Dessalement

Dissalazione

EP

Energy

Borehole Electric Mixed Flow pumps 6" – 8"

Electropompes Immergées Semi Axiales 6" - 8"

Elettropompe Sommersa Semiassiali 6" – 8"

The new Energy line is distinguished by innovative materials, sophisticated production processes and pioneering research methods.

Matériaux novateurs, procédés de production dernier cri et méthodes de recherche à l'avant-garde sont les traits distinctifs de la nouvelle ligne Energy.

Materiali innovativi, processi produttivi sofisticati e metodi di ricerca all'avanguardia sono i tratti distintivi della nuova Energy.



NEXT GENERATION

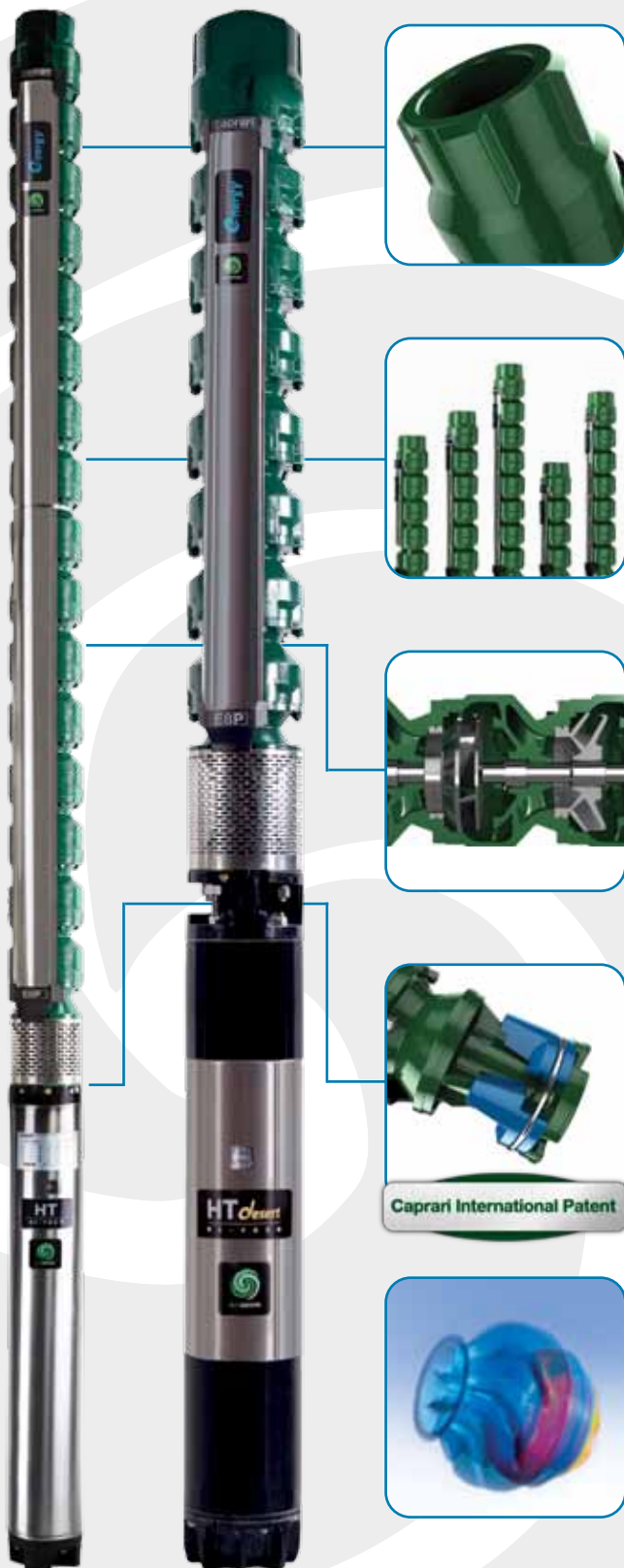

- C** Versatility of installation: flange coupling and threaded coupling
Polyvalence d'installation : accouplement à brides plates, à brides DIN et à filetage
Versatilità di installazione: accoppiamento a flange piane, a flange DIN e filettato



- C** Product modularity
Strong standardization of components
Conception modulaire du produit
Forte standardisation des composants
Modularità del prodotto
Forte standardizzazione dei componenti

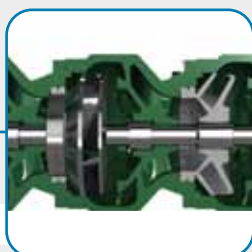

- C** Strong construction: high thickness grants wear resistance and a long working life. Guaranteed performances on the duty point thanks to the impeller trimming
Construction dans la masse : fortes épaisseurs en garantie d'une longue durée de vie et de résistance à l'usure. Performances garanties sur le point de travail grâce à l'ajustage de la roue
Costruzione massiva: alti spessori a garanzia di lunga durata e resistenza all'usura. Prestazioni garantite sul punto di lavoro grazie alla tornitura girante



- C** Casting technologies NEXT GENERATION: smooth surface
Technologies de fusion NEXT GENERATION : surface lisse et sans discontinuité
Tecnologie di fusione NEXT GENERATION: superficie liscia e senza discontinuità
- C** Guarantee of superior performances in heavy duty: maximum content of solids 100 g/m³
Garantie de grandes performances dans les applications lourdes : quantité max de solides 100 g/m³
Garanzia di maggiori prestazioni in impieghi gravosi: quantità max solidi 100 g/m³



- C** DEFENDER®
Complete resistance to corrosion thanks to the patented device
DEFENDER®
Résistance totale à la corrosion grâce au dispositif breveté
DEFENDER®
Totale resistenza alla corrosione grazie al dispositivo brevettato
- C** NEXT GENERATION: Best in Class efficiencies and Benchmark performance
NEXT GENERATION : rendements Best in Class et point de référence
NEXT GENERATION: rendimenti Best in Class e prestazioni Benchmark

EP



NEXT GENERATION



C Machines conform to 2009/125/EC Directive (EcoDesign - ErP)
 Machines conformes à la Directive 2009/125/CE (EcoDesign - ErP)
 Macchine conformi alla Direttiva 2009/125/CE (EcoDesign - ErP)



Flow rates up to <i>Débits jusqu'à</i> Portate fino a	48 l/s
Heads up to <i>Hauteurs de refoulement jusqu'à</i> Prevalenze fino a	460 m
Power up to <i>Puissances jusqu'à</i> Potenze fino a	92 kW
Poles <i>Poles</i> Poli	2

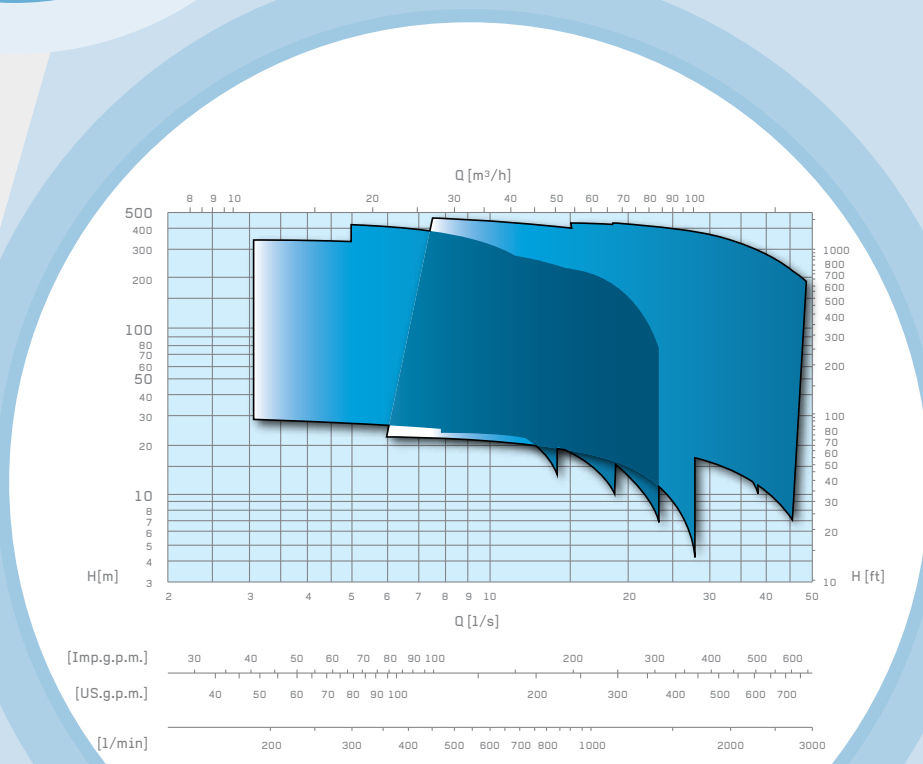

[Imp.g.p.m.] 30 40 50 60 70 80 90 100 200 300 400 500 600
 [US.g.p.m.] 40 50 60 70 80 90 100 200 300 400 500 600 700
 [l/min] 200 300 400 500 600 700 800 1000 2000 3000

ES

Borehole Electric Mixed Flow pumps 10"÷18"

Electropompes Immergées Semi Axiales 10"÷18"

Elettropompe Sommersa Semiassiali 10"÷18"



Borehole electric pumps coupled with asynchronous submersible motors at 2.900 and 1.450 rpm. Tried and tested machines whose ideal use is for lifting medium flows and medium heads. These pumps are installed in wells all over the world with unanimous satisfaction of the users. Sturdy construction of cast iron, bronze or stainless steel with impellers locked on the stainless steel shaft. Their design makes them especially suited for lifting water containing sand.

Electropompes accouplées à des moteurs immergés asynchrones à 2.900 et 1.450 t/min. Machines testées qui trouvent leur emploi idéal dans le relevage des débits et des hauteurs de refoulement moyens. Ces pompes sont installées dans des puits du monde entier pour l'entière satisfaction des utilisateurs. Construction robuste en fusion de fonte, de bronze ou acier inox avec turbines fixées sur l'arbre en acier inox. La configuration conceptuelle les rend particulièrement adaptées au relevage d'eau contenant du sable.

Elettropompe accoppiate a motori sommersi asincroni a 2.900 e 1.450 g/min. Macchine collaudatissime che trovano il loro impiego ideale per sollevamento di medie portate e medie prevalenze. Queste pompe Caprari sono installate in pozzi di tutto il mondo con unanime soddisfazione degli utilizzatori. Costruzione robusta in fusioni di ghisa, bronzo o acciaio inox con giranti calettate sull'albero in acciaio inox. La configurazione progettuale le rende particolarmente adatte per il sollevamento d'acqua con presenza di sabbia.

Flow rates up to

Débits jusqu'à

Portate fino a

250 l/s

Heads up to

Hauteurs de refoulement jusqu'à

Prevalenze fino a

600 m

Power up to

Puissances jusqu'à

Potenze fino a

370 kW

Poles

Poles

Poli

2/4

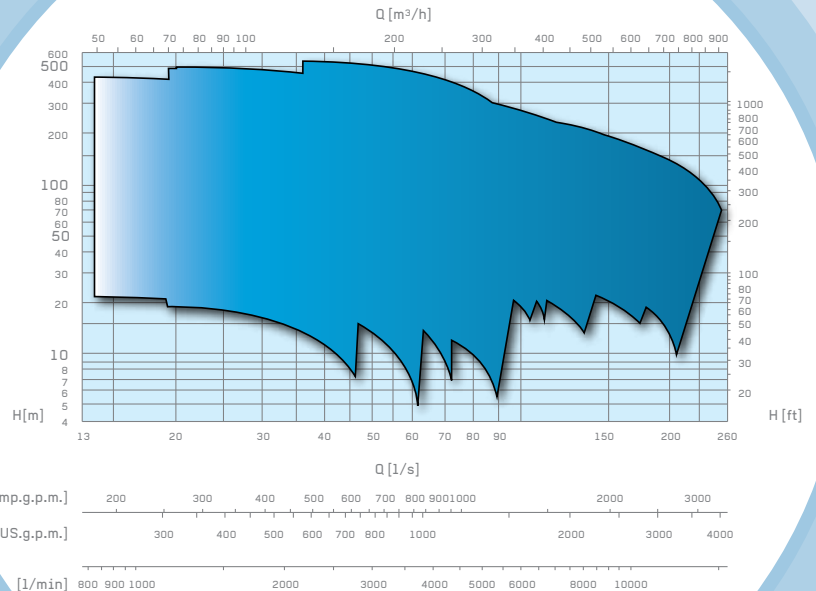

ES

Borehole Electric Mixed Flow pumps 20" - 22"

Electropompes Immergées Semi Axiales 20" - 22"

Elettropompe Sommersa Semiassiali 20" - 22"



Borehole electric mixed flow for lifting pumps that require medium-high flows. Coupled to asynchronous submersible motors at 1.450 rpm, thanks to the low speed of rotation they ensure great reliability with low wear and a long life. Sturdy construction of cast iron, bronze or stainless steel with impellers locked on the stainless steel shaft. These electric pumps are particularly suited for continuous use in water supply, treatment systems and industrial systems in general where, besides their great reliability, energy savings play a fundamental role ensured by the excellent hydraulic efficiencies that characterise these electric pumps.

Electropompes semi-axiales pour les relevages qui nécessitent des débits moyens-élevés. Accouplées à des moteurs immergés asynchrones à 1.450 t/min, grâce à une faible vitesse de rotation elles assurent une grande fiabilité avec faible usure et excellente longévité. Construction robuste en fusion de fonte, de bronze ou acier inox avec turbines fixées sur l'arbre en acier inox. Ces électropompes sont particulièrement indiquées pour un emploi continu dans les réseaux de distribution d'eau, les installations d'assainissement et les installations industrielles en général, où l'économie d'énergie est garantie par les excellents rendements hydrauliques de ces électropompes d'une grande fiabilité.

Elettropompe sommersa semiassiali 20" - 22" per sollevamenti che richiedono portate medio-alte. Accoppiate a motori sommersi asincroni a 1.450 g/min, grazie alla bassa velocità di rotazione assicurano una grande affidabilità con ridotte usure e lunga durata. Costruzione robusta in fusioni di ghisa, bronzo o acciaio inox con giranti calettate sull'albero in acciaio inox. Queste elettropompe sono particolarmente indicate per un utilizzo continuativo in acquedottistica, impianti di bonifica e impianti industriali in genere, dove oltre alla grande affidabilità gioca un ruolo fondamentale il risparmio energetico garantito dagli ottimi rendimenti idraulici che caratterizzano queste elettropompe.

Flow rates up to

Débits jusqu'à

Portate fino a

350 l/s

Heads up to

Hauteurs de refoulement jusqu'à

Prevalenze fino a

130 m

Power up to

Puissances jusqu'à

Potenze fino a

240 kW

Poles

Poles

Poli

4

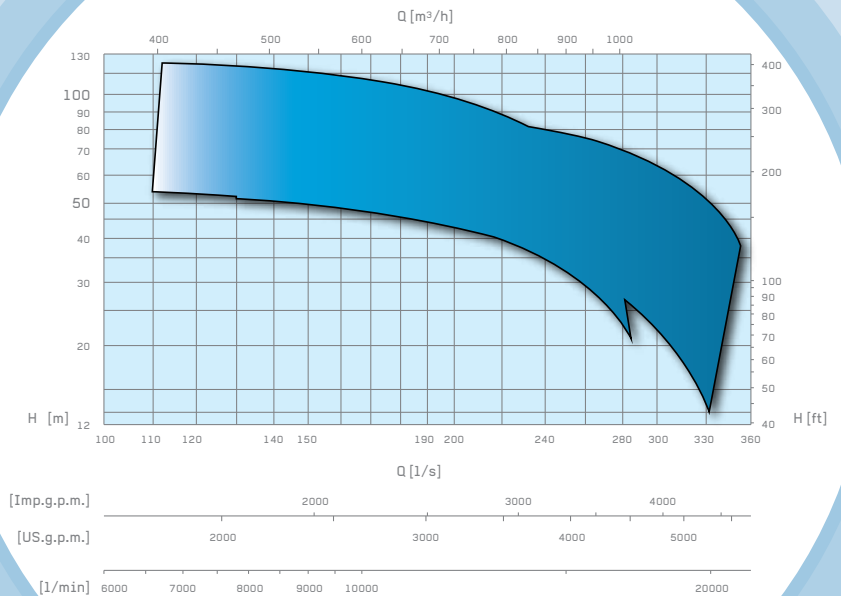

ER

Borehole Electric Radial pumps 8" - 10"

Electropompes Immersées Radiales 8" - 10"

Elettropompe Sommersa Radiali 8" - 10"



Borehole electric 8" and 10" radial pumps able to reach high heads. Thanks to the limited axial dimensions of the wet-end these machines feature a high number of stages with limited length so as to make them compact and reliable. Very solid machines, designed to last and to always ensure peak performance and efficiency under harsh conditions of use at great depths of installation and extremely high heads.

Electropompes sont a même d'atteindre des hauteurs manométriques importantes. Compactes et fiables, ces machines sont caractérisées par un nombre d'étages élevés mais un encombrement réduit. Machines particulièrement solides, conçues pour durer et pour garantir performances et efficacité maximums, dans des conditions d'emploi astreignantes comme les grandes profondeurs d'installation et des hauteurs de refoulement exceptionnelles.

Elettropompe in grado di raggiungere alte prevalenze. Grazie al limitato ingombro assiale degli elementi idraulici, queste macchine sono caratterizzate da un elevato numero di stadi con una lunghezza contenuta in modo da renderle compatte ed affidabili. Macchine particolarmente solide, progettate per durare e per garantire sempre massime prestazioni ed efficienza, in condizioni di impiego impegnative a grandi profondità d'installazione ed elevatissime prevalenze.

Flow rates up to

Débits jusqu'à

Portate fino a

37 l/s

Heads up to

Hauteurs de refoulement jusqu'à

Prevalenze fino a

770 m

Power up to

Puissances jusqu'à

Potenze fino a

170 kW

Poles

Poles

Poli

2

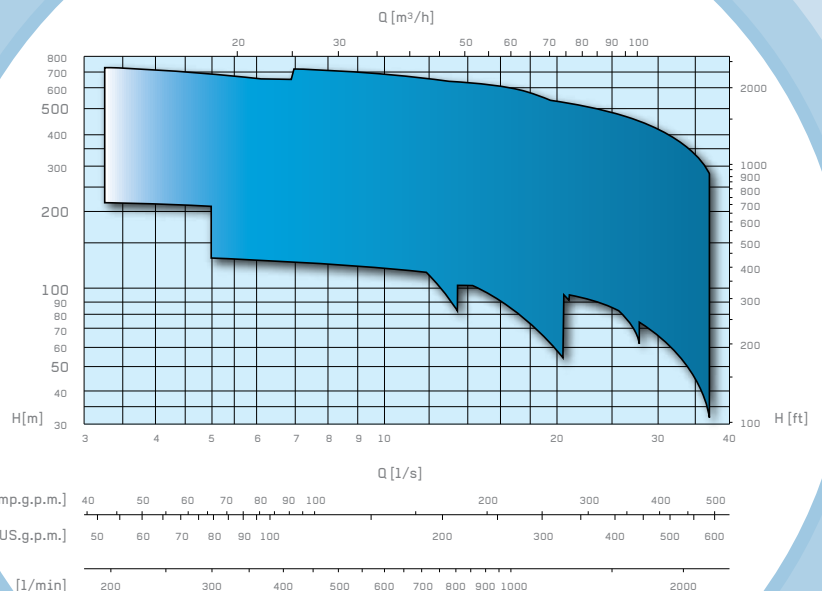

M

Submersible Motors 6" ÷ 14" Moteurs Immergés 6" ÷ 14" Motori Sommersi 6" ÷ 14"



Asynchronous three-phase rewindable submersible motors designed for use with the pumps of the "E" Series. Made both in 2 and 4 poles, water filled for perfect cooling and safe lubrication. The careful study of support systems and thrust bearing devices, using the best materials available, guarantees superior lasting reliability. An exclusive electric design together with a series of specific stratagems, dictated by wide experience in the field, provide incomparable efficiency of operation, both in deep wells and in industrial or aqueduct applications. Available in different material.

Moteurs immergés à enroulement, asynchrones triphasés, conçus pour emploi avec les pompes de la série "E". Réalisés tant à 2 qu'à 4 pôles, à bain d'eau, pour un parfait refroidissement et une lubrification sûre. L'étude attentive des supports et des butées, avec l'emploi des meilleurs matériaux disponibles, sont la meilleure garantie d'une grande fiabilité dans le temps.

Un projet électrique exclusif uni à une série de précautions spécifiques, dictés par une importante expérience dans le domaine, fournissent une efficacité de fonctionnement incomparable tant dans les puits profonds que dans les utilisations industrielles ou de distribution d'eau. Disponibles en différentes métallurgies.

Motori sommersi riavvolgibili, asincroni trifase, progettati per l'impiego con pompe della serie "E". Realizzati sia a 2 che a 4 poli, a bagno d'acqua per un perfetto raffreddamento e sicura lubrificazione. L'attento studio delle supportazioni e dei dispositivi reggispinta, con l'utilizzo dei migliori materiali disponibili sono garanzia dell'affidabilità nel tempo. Un esclusivo progetto elettrico unito ad una serie di soluzioni specifiche, frutto dell'esperienza, forniscono un'efficienza di funzionamento incomparabile sia nei pozzi profondi che in impieghi industriali o in acquedottistica. Disponibili in diverse metallurgie costruttive.

TOGETHER EVEN STRONGER

Caprari's entire series of borehole electric pumps is designed to protect the pump/motor coupling zone. Moreover, the special PROTECTOR® device installed in Nema couplings between the wet-end and motor perfectly seals the coupling zone and protects it and the seal in the motor from sand.

Toute la série d'électropompes immergées Caprari est projetée de manière à protéger la zone d'accouplement pompe/moteur. En outre, dans les accouplements Nema, le dispositif spécial PROTECTOR® inséré dans la partie hydraulique et le moteur ferme hermétiquement la zone d'accouplement en protégeant du sable la zone du joint et celle d'étanchéité du moteur.

Tutta la serie di elettropompe sommerse Caprari è progettata in modo da proteggere la zona di accoppiamento pompa/motore. Inoltre, negli attacchi Nema, lo speciale dispositivo PROTECTOR® inserito tra idraulica e motore sigilla perfettamente la zona proteggendo dalla sabbia il giunto e la tenuta nel motore.



Caprari International Patent

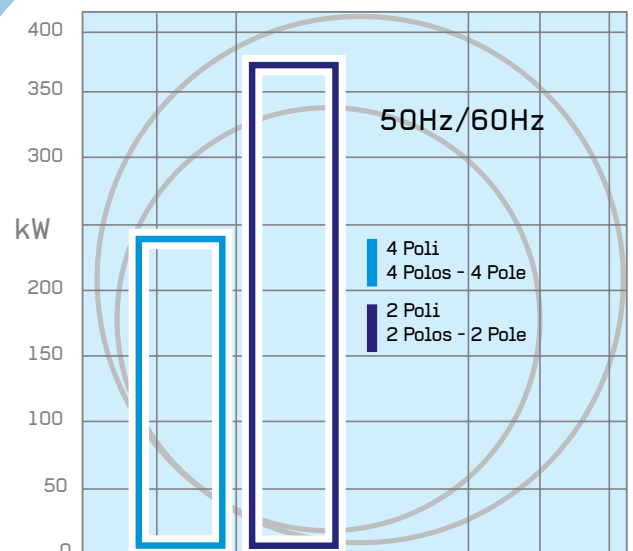

MAC 6"

The new generation of submersible motors stands out for innovation, technology and uniqueness. A result achieved through a steady research, with the application of the most modern methods of design integrated with the most advanced production technologies. These submersible motors guarantee very high performances, absolute reliability in harsh conditions of use and strong resistance to high temperatures.

La nouvelle génération de moteurs immergés s'impose par l'innovation, la technologie et l'unicité. Ils sont le résultat d'une recherche constante et de l'application des méthodes de conception les plus modernes, intégrées aux technologies de production d'avant-garde. La garantie de très hautes performances, d'une fiabilité maximale dans des conditions d'utilisation difficiles et d'une résistance aux températures élevées.

La nuova generazione di motori sommersi si distingue per innovazione, tecnologia ed unicità. Sono il risultato di una costante ricerca, con l'applicazione delle più moderne metodologie di progettazione, integrate nelle più avanzate tecnologie produttive. Garantiscono elevatissime prestazioni, massima affidabilità in condizioni di utilizzo gravose ed elevata resistenza alle alte temperature.



NEXT GENERATION



THE HIGH VALUE SOLUTION

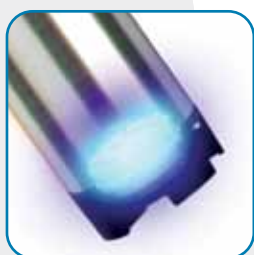

- C** Line bearing:
 - innovative and self-lubricating composite material*Roulements de ligne:*
 - *matériau composite autolubrifiant novateur***Cuscinetti di linea:**
 - **innovativo materiale composito autolubrificante**

- C** Mechanical seal:
 - it guarantees easy availability on the market*Garniture mécanique de série:*
 - *la garantie d'être facile à trouver dans le commerce***Tenuta meccanica di serie:**
 - **assicura facile reperibilità sul mercato**

- C** HT WIRE:
 - inverter resistant
 - reliable and durable*HT WIRE :*
 - *variateur résistant*
 - *fiable et solide***HT WIRE:**
 - **inverter resistant**
 - **affidabile e duraturo**

Caprari International Patent

- C** Recyclable materials and resin free
 - *Matériaux recyclables et exempts de résine***Materiali riciclabili e resin free**

- C** Rewindable motors: simplicity of maintenance
 - *Moteurs enrouleurs : simplicité d'entretien***Motori riavvolgibili: semplicità di manutenzione**

- C** HT Bearing:
 - strong resistance to the axial thrust
 - extreme reliability*Roulement HT :*
 - *résistance maximale à la poussée axiale*
 - *fiabilité extrême***Cuscinetto HT:**
 - **massima resistenza alla spinta assiale**
 - **estrema affidabilità**

Power <i>Puissances</i> Potenze	4 ÷ 30 kW
Frequency <i>Fréquences</i> Frequenza	50 - 60 Hz
Poles <i>Poles</i> Poli	2

Caprari International Patent

MAC 6''



NEXT GENERATION



THE SUPER PREMIUM SOLUTION



- ☑ HT Winding with high resistance:
 - Best in Class
 - for heavy uses*Enroulement HT à haute résistance :*
 - *Best in Class*
 - *pour applications lourdes***Avvolgimento HT ad alta resistenza:**
 - **Best in Class**
 - **per impieghi gravosi**

- ☑ Caprari desert design:
 - high resistance to sand*Caprari desert design :*
haute résistance au sable
Caprari desert design:
alta resistenza alla sabbia

- ☑ Mechanical seal for sand (SiC/SiC)
Garniture mécanique pour sable (SiC/SiC)
Tenuta meccanica per sabbia (SiC/SiC)

Power
Puissances
Potenze 4 ÷ 45 kW

Frequency
Fréquences
Frequenza 50 - 60 Hz

Poles
Poles
Poli 2

HT – HIGH TECH

HT – HIGH THRUST



Caprari International Patent

M

Submersible Motors 8" ÷ 14"
Moteurs Immergès 8" ÷ 14"
Motori Sommersi 8" ÷ 14"

2 Poles
Poles
Poli

Power <i>Puissances</i> Potenze a	30 ÷ 440 kW
Frequency <i>Fréquences</i> Frequenza	50 - 60 Hz

4 Poles
Poles
Poli

Power <i>Puissances</i> Potenze	15 ÷ 295 kW
Frequency <i>Fréquences</i> Frequenza	50 - 60 Hz



MotorGuard



MotorGuard is an electronic device for controlling and monitoring the electric pump units with threephase asynchronous electric motors. **MotorGuard** can be built into the URM Caprari remote management system so as to allow the electric pump to be monitored in the remote mode.

***MotorGuard** est un dispositif électronique pour contrôler et surveiller les groupes électropompe avec moteur électrique asynchrone triphasé. **MotorGuard** peut être intégré dans le système de télécontrôle URM Caprari pour faciliter la surveillance de l'électropompe même à distance.*

MotorGuard è un dispositivo elettronico per controllare e monitorare i gruppi elettropompa con motore elettrico asincrono trifase. **MotorGuard** può essere integrato al sistema di telecontrollo URM Caprari per facilitare il monitoraggio dell'elettropompa anche in remoto.

Borehole Electric pumps 6" - 8"

Electropompes Immergées 6" - 8"

Elettropompe Sommersa 6" - 8"



C ENDURANCE, the range of fully stainless steel borehole pumps, is entirely made of precision castings. ENDURANCE provides an excellent performance in the most extreme conditions with salty, aggressive and sandy water.

ENDURANCE, la gamme d'électropompes immergées tout inox entièrement réalisées par moulage de précision. ENDURANCE a été projetée pour offrir de très hautes performances dans les conditions extrêmes pour les eaux saumâtres, agressives et sablonneuses.

ENDURANCE, la gamma di elettropompe sommersa full inox, è interamente realizzata in fusione di precisione. ENDURANCE è progettata per funzionare nelle condizioni più estreme in acque salmastre, aggressive e sabbiose.

C DEFENDER[®], a smart device designed, tested and patented by Caprari to protect the electric pumps from electrochemical corrosion and galvanic currents, passivating the stainless steel so as to create a further safety barrier.

DEFENDER[®], un dispositivo intelligente studiato, testato e brevettato da Caprari per proteggere le elettropompe contro la corrosione elettrochimica e les courants galvaniques, en protégeant l'acier inoxydable en créant une barrière supplémentaire de sécurité.

DEFENDER[®], un dispositivo intelligente studiato e testato da Caprari per proteggere le elettropompe dalla corrosione elettrochimica e dalle correnti galvaniche tramite passivazione dell'acciaio inox creando un'ulteriore barriera di sicurezza.

Machines conform to 2009/125/EC Directive (EcoDesign - ErP)

Machines conformes à la Directive 2009/125/CE (EcoDesign - ErP)

Macchine conformi alla Direttiva 2009/125/CE (EcoDesign - ErP)

Ref.: PUMP CONTROL TECHNOLOGY brochure



Caprari International Patent

Flow rates up to

Débits jusqu'à

50 l/s

Portate fino a

Heads up to

Hauteurs de refoulement jusqu'à

850 m

Prevalenze fino a

Power up to

Puissances jusqu'à

170 kW

Potenze fino a

Poles

Poles

2

Poli

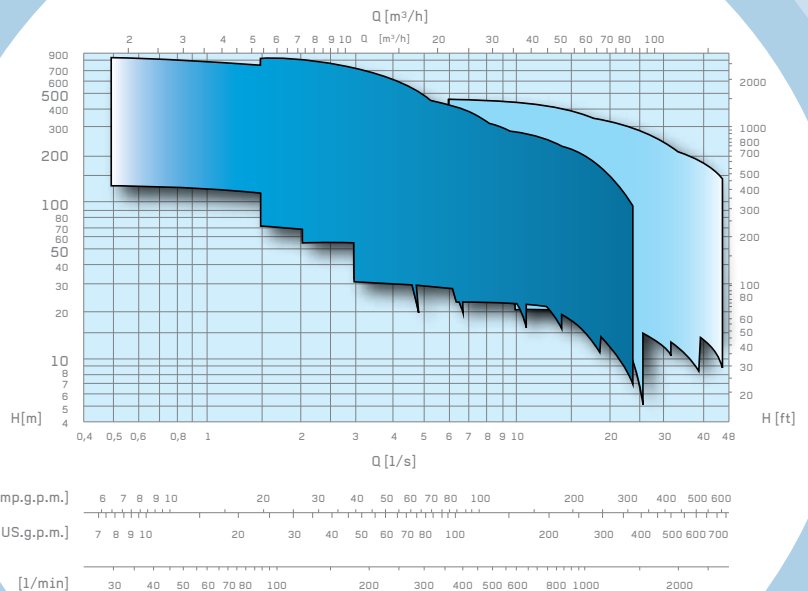

Desert**LINE**The right choice for high concentrations of solids and sand up to 300 g/m³*La solution pour les fortes concentrations de solides et de sable jusqu'à 300 g/m³***La soluzione per alte concentrazioni di solidi e sabbia fino a 300 g/m³****NEXT GENERATION**

- C** Bushings in sandproof material
Bagues en matériau anti-sable
Bussole in materiale antisabbia

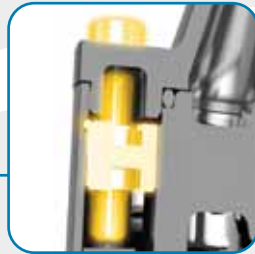

- C** Bearing protection
Protection du palier de support
Protezione della supportazione



- C** Caprari **Smart-Fix System**
Valve-pump casing fastening system
*Caprari **Smart-Fix System***
Système de fixation clapet/corps de pompe
Caprari Smart-Fix System
Sistema di fissaggio valvola-corpo pompa



- C** Impellers in technopolymer with additional reinforcing
Roues en polymère technique à haute résistance à l'abrasion
Giranti in tecnopolimero ancora più rinforzato

- C** **Defender®**: protects both pump and electric motor from corrosion and galvanic currents by passivating the stainless steel
***Defender®**: fait fonction d'inhibiteur de la corrosion électro-chimique, en permettant la passivation de l'acier inoxydable, il protège aussi bien la pompe que le moteur électrique*
Defender®: funge da protettore sia della pompa che del motore elettrico, dalla corrosione e dalle correnti galvaniche passivando l'acciaio inox



- C** Bearings protected against the entrance of sand
Coussinets protégés des entrées de sable
Cuscinetti protetti dall'ingresso di sabbia



- C** Performance in accordance with ISO9906 standard grade 3B
Performances selon les normes ISO 9906 grade 3B
Prestazioni secondo la norma ISO 9906 grado 3B



- C** Machines conform to 2009/125/EC Directive (EcoDesign – ErP)
Machines conformes à la Directive 2009/125/CE (EcoDesign – ErP)
Macchine conformi alla Direttiva 2009/125/CE (EcoDesign - ErP)

Certification for use with drinking water: DM174, WRAS, ACS, KTW-W270

*Certification pour l'emploi en eau potable : DM174, WRAS, ACS, KTW-W270***Certificazione per l'impiego in acqua potabile: DM174, WRAS, ACS, KTW-W270**

EXtra P performance

up to **450 g/m³**

Desert

pumps for specific applications with high percentage of solids and sand

pompes pour applications spécifiques à haute teneur en solides et sable

pompe per applicazioni specifiche ad alto contenuto di sabbia



E6XPD52

with Smart-Fix System

avec Smart-Fix System

con Smart-Fix System

Caprari International Patent



Flow rates up to

Débits jusqu'à

Portate fino a

12 l/s

Heads up to

Hauteurs de refoulement jusqu'à

Prevalenze fino a

680 m

Power up to

Puissances jusqu'à

Potenze fino a

37 kW

Poles

Poles

Poli

2

Ref.: DESERT LINE brochure

Desert

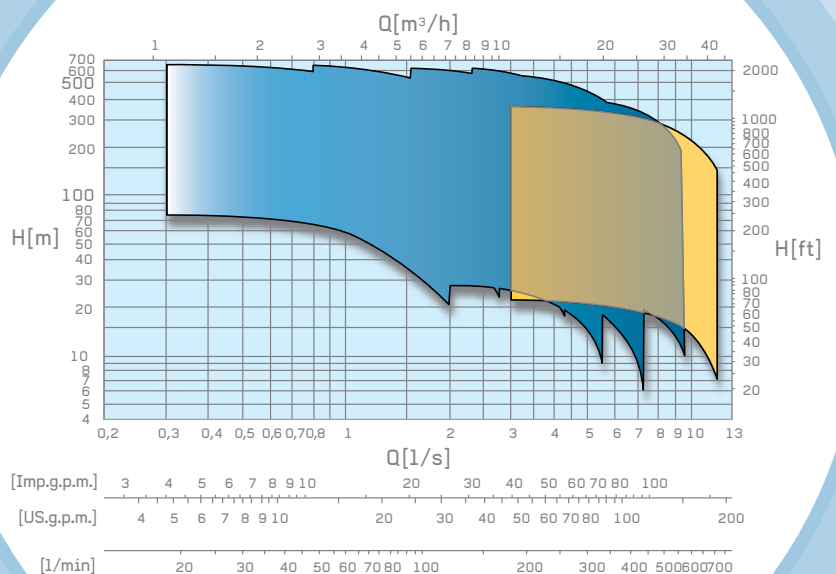

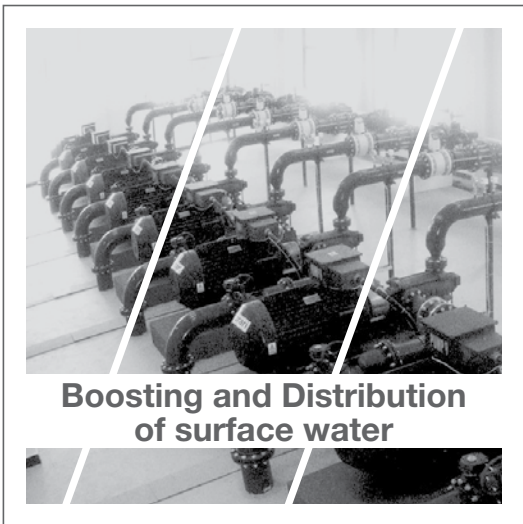
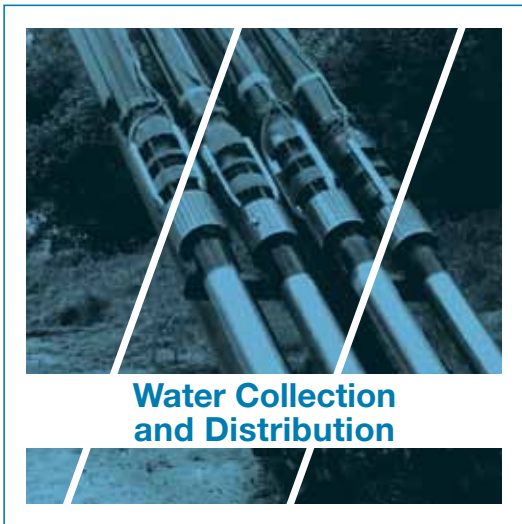
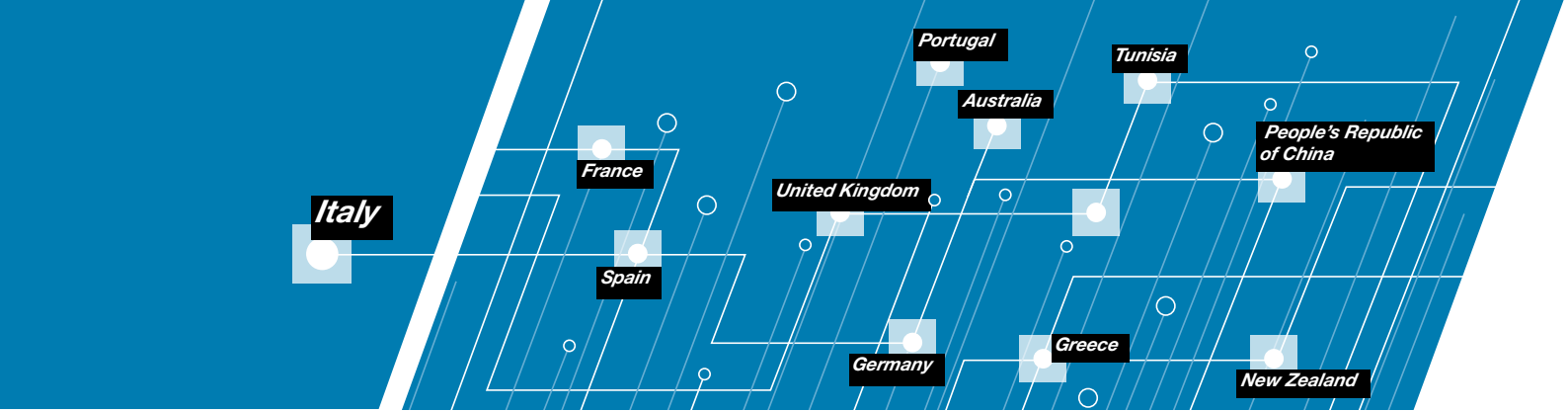

caprari
pumping power

