

# NM, NMD

## Pompes centrifuges monobloc avec orifices taraudés



### Exécution

Electropompes centrifuges monobloc avec accouplement direct moteur-pompe et arbre unique.

**NM**: à un étage.

**NMD**: à deux roues opposées (avec équilibrage de poussée axiale).

**Orifices**: taraudés ISO 228/1.

1

### Utilisations

- Pour liquides propres sans particules abrasives, non agressifs pour les matériaux de la pompe (avec parties solides jusqu'à 0,2% max.).
- Pour l'approvisionnement en eau.
- Pour les installations de chauffage, conditionnement, refroidissement.
- Pour applications civiles et industrielles.
- Pour service incendie. - Pour irrigation.

### Limites d'utilisation

Température du liquide de -10 °C à +90 °C.

Température ambiante jusqu'à 40 °C.

Hauteur d'aspiration manométrique jusqu'à 7 m.

Pression finale maximum admise dans le corps de la pompe: 10 bar (16 bar pour pompes NMD 25/190; NMD 32/210; NMD 40/180).

Service continu.

### Moteur

Moteur à induction à 2 pôles, 50 Hz (n = 2900 1/min).

**NM, NMD**: triphasé 230/400 V ± 10% jusqu'à 3 kW;  
 400/690 V ± 10% de 4 à 9,2 kW;

**NMM, NMDM**: monophasé 230 V ± 10%,  
 avec protection thermique.

Isolation classe F.

Protection IP 54.

Exécution selon IEC 60034.

### Exécutions spéciales sur demande

- Autres voltages.
- Fréquence 60 Hz.
- Protection IP 55.
- Garniture mécanique spéciale.
- Pour liquide ou ambiante avec températures plus élevées ou plus basses.

### Matériaux

Composant	NM, NMD	B-NM, B-NMD
Corps pompe	Fonte	Bronze
Lanterne de racc.	GJL-200 EN 1561	G-Cu Sn 10 EN 1982
Roue	Laiton P- Cu Zn 40 Pb 2 UNI 5705	
NM 17	Fonte	Bronze
	GJL-200 EN 1561	G-Cu Sn 10 EN 1982
Arbre	Acier au Cr AISI 430	Acier au Cr Ni Mo AISI 316
	Acier au Cr Ni AISI 303 de 1,1-1,5-2,2 kW	
Garniture mécan.	Carbone dur - céramique - NBR	

### Graphique d'utilisation n ≈ 2900 1/min

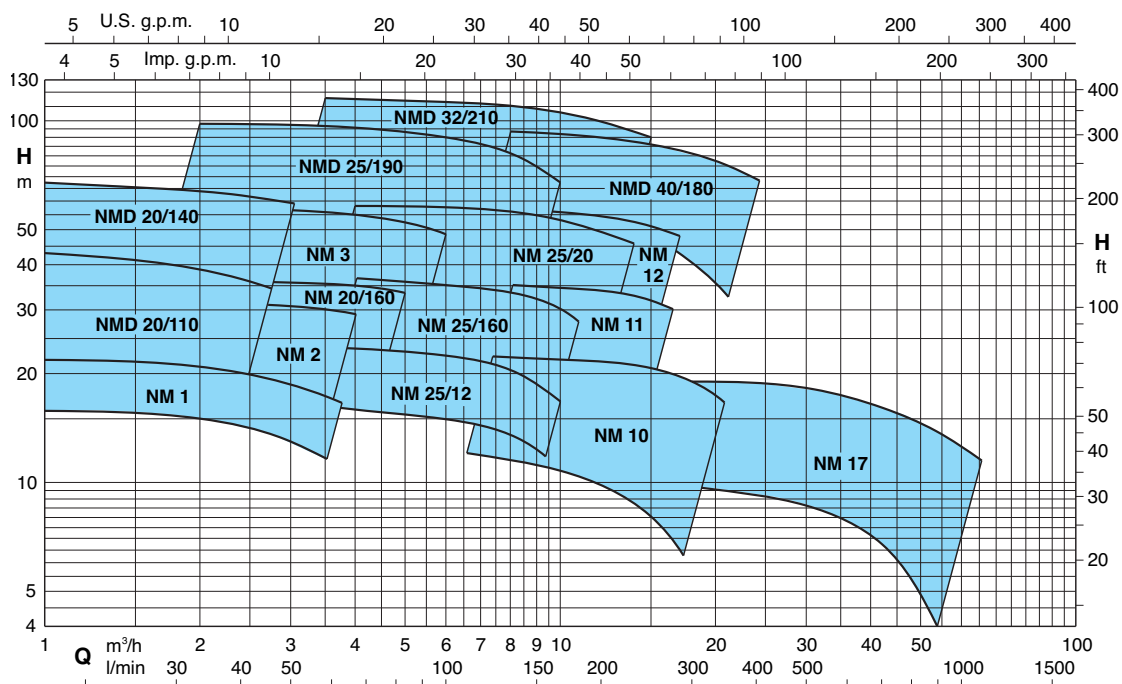

### Performances n ≈ 2900 1/min

	NM	P <sub>2</sub>		Q m <sup>3</sup> /h														
		kW	HP		l/min													
				1	1,2	1,5	1,89	2,4	3	3,6	4,2	4,8	5,4	6	6,6	7,5	8,4	
					16	20	25	31,5	40	50	60	70	80	90	100	110	125	140
	NM 1/AE●	0,37	0,5	H m	22	21,6	21,3	20,9	20,3	19,4	18,1	16,3						
	NM 2/BE●	0,55	0,75		27	26,5	26	25,5	25	24	23	22	20					
	NM 2/SE●	0,55	0,75		31	30,5	30	29	27,5	25,5	23,5	20	16					
	NM 2/AE●	0,75	1		33,5	33	32,5	32	31,5	30,5	29,5	28,5	27	26	24			
	NMM 3/CE	1,1	1,5			37,5	37,5	37	36,5	36	35	34	32					
	NM 3/CE	1,1	1,5			37,5	37,5	37	36,5	36	35	34	32	30,5*	28,5*			
	NMM 3/BE	1,5	2			42	42	41	41,5	40,5	40	39	37	35*	32*			
	NM 3/BE	1,5	2			47	47	46,5	46	45,5	45	44	43	41,5*	40*	37,5*	33*	26*
	NM 3/AE	2,2	3			56	55,5	55,5	55	54,5	53,5	52,5	51,5	50*	48*	46*	42*	36*

B-NM B-NMD	NM NMD	P <sub>2</sub>		Q m <sup>3</sup> /h														
		kW	HP		l/min													
				1	1,2	1,5	1,89	2,4	3	3,6	4,2	4,8	5,4	6	6,6	7,5	8,4	
					16	20	25	31,5	40	50	60	70	80	90	100	110	125	140
B-NMD 20/110BE●	NMD 20/110BE●	0,45	0,6	H m	33	32	31	29	26,5	23	18							
B-NMD 20/110ZE●	NMD 20/110ZE●	0,55	0,75		37	36	35	33	30,5	27,5	23	18*						
B-NMD 20/110AE●	NMD 20/110AE●	0,75	1		43	42	40,5	39	36,5	33	29	25*						
B-NMDM 20/140BE	NMDM 20/140BE	1,1	1,5		52	51,5	51	50	48,5	47	45							
B-NMD 20/140BE	NMD 20/140BE	1,1	1,5		53	52,5	52	51	50	48	46	43,5	40					
B-NMDM 20/140AE	NMDM 20/140AE	1,5	2		57,5	57	56,5	55,5	54	51,5	49	46	43	40	36			
B-NMD 20/140AE	NMD 20/140AE	1,5	2		67	66,5	66	64,5	63	61,5	59	57	53,5	50	46			
B-NM 20/160BE●	NM 20/160BE●	0,75	1					30,5	30	29,5	28,5	27,5	26,5	25,5	24	22*		
B-NM 20/160AE●	NM 20/160AE●	1,1	1,5					36	35,5	35	34,5	33,5	32	30,5	29	27*		

B-NM B-NMD	NM NMD	P <sub>2</sub>		Q m <sup>3</sup> /h														
		kW	HP		l/min													
				2,4	3	3,6	4,8	6	6,6	7,5	8,4	9,6	10,8	12	13,2	15	16,8	
					40	50	60	80	100	110	125	140	160	180	200	220	250	280
B-NM 25/12BE●	NM 25/12BE●	0,55	0,75	H m	20	19,9	19,8	19,3	18,5	18	17,3	16,3	15*	13,2*	11*			
B-NM 25/12AE●	NM 25/12AE●	0,75	1		23,5	23,4	23,3	22,9	22,1	21,7	20,9	20	18,7*	17,1*	15,2*			
B-NM 25/160BE●	NM 25/160BE●	1,1	1,5			31	30,7	30	28,5	28	27	26	23					
B-NM 25/160AE●	NM 25/160AE●	1,5	2			36,5	36,2	35,5	34,5	34	33,5	32,5	31	28,5*	26*			
B-NM 25/200BE	NM 25/20BE	2,2	3			42,5	42	41	40	39,5	38,5	37,5	36	33*	29*			
B-NM 25/200AE	NM 25/20AE	3	4			50	49,7	49	48	47,5	47	46,5	45,5	44*	42*	39*		
B-NM 25/200SE	NM 25/20SE	4	5,5			59	58,5	58	57,5	57	56,5	55,5	54,5	53	51,5	49*	44,5*	37*
B-NMD 25/190CE	NMD 25/190CE	2,2	3			62	60,5	59	55,5	51	48,5	44	38*					
B-NMD 25/190BE	NMD 25/190BE	3	4			76	75	74	70	66	64	60	54	46*				
B-NMD 25/190AE	NMD 25/190AE	4	5,5		98	97	96	93,5	90	88	84	79	70*					

	NM	P <sub>2</sub>		Q m <sup>3</sup> /h														
		kW	HP		l/min													
				6,6	7,5	8,4	9,6	10,8	12	13,2	15	16,8	18,9	21	24	27	30	
					110	125	140	160	180	200	220	250	280	315	350	400	450	500
	NM 10/FE●	0,55	0,75	H m	12,5	12,5	12	11,5	11	10	9	7,5						
	NM 10/DE●	0,75	1		18	18	17,5	17	16,5	16	15,5	14						
	NM 10/AE●	1,1	1,5		23	23	22,5	22	21,5	21	20,5	19						
	NM 10/SE●	1,5	2		23,5	23,5	23	22,5	22	21,5	21	20,5	19*	18,5*	16,5*	13*		
	NMM 11/BE	1,5	2		26,5	25,5	25	24	23	22,5	21,5	19,5	17,5					
	NM 11/BE	1,5	2		29,5	29,5	29	28,5	27,5	27	26	25*	22,5*					
	NM 11/AE	2,2	3		35,5	35,5	35	34,5	34	33,5	33	32*	30*					
	NM 12/DE	2,2	3		38	37,5	37	36	35	33,5	32							
	NM 12/CE	3	4		45	44,5	44	43,5	42,5	41	40	38	36*					
	NM 12/AE	4	5,5	57,5	57	56	55,5	55	54,5	53,5	51,5	49*						

### Performances n ≈ 2900 1/min

1

B-NMD	NMD	P <sub>2</sub>		Q m <sup>3</sup> /h l/min	5,4	6	6,6	7,5	8,4	9,6	10,8	12	13,2	15	16,8	18,9	21	24										
		kW	HP																									
																	90	100	110	125	140	160	180	200	220	250	280	315
B-NMD 32/210DE	NMD 32/210DE	4	5,5	H m	71	69	67,5	65	62,5	58	53	46	37*															
B-NMD 32/210CE	NMD 32/210CE	5,5	7,5		84	83	82	81	79	76	73	69	64*	54*														
B-NMD 32/210BE	NMD 32/210BE	7,5	10		104	103	102	100	98	95	92	88	84*	76*														
B-NMD 32/210AE	NMD 32/210AE	9,2	12,5		114	113	112	110	108	105	103	99	96*	90*														
B-NMD 40/180DE	NMD 40/180DE	4	5,5					60	59,5	57	56	53	51,5	48	44	39	34*	25*										
B-NMD 40/180CE	NMD 40/180CE	5,5	7,5					69	68	67	66	64,5	63	60	57	53	48*	40*										
B-NMD 40/180BE	NMD 40/180BE	7,5	10					87	86	85	84	82,5	81	78	75	71	66*	59*										
B-NMD 40/180AE	NMD 40/180AE	9,2	12,5					94	93	92	91	89,5	88	85	82	78	74*	67*										

B-NM	NM	P <sub>2</sub>		Q m <sup>3</sup> /h l/min	21	24	27	30	33	37,8	42	48	54	60	66	75	84	96									
		kW	HP																								
																350	400	450	500	550	630	700	800	900	1000	1100	1250
B-NM 17/HE●	NM 17/HE●	1,1	1,5	H m	9,5	9,2	9	8,6	8,2	7,5	6,7	5,5	3,5*														
B-NM 17/GE●	NM 17/GE●	1,5	2		12	11,7	11,5	11,2	11	10,3	9,7	8,5	7*	4*													
B-NM 17/FE	NM 17/FE	2,2	3			16	16	15,5	15	14,5	14	13	11,5*	10*	8*												
B-NM 17/DE	NM 17/DE	3	4					18	18	17,5	17	16,5	15,5	14*	13*	11,5*											

NM, NMD Construction normale  
 B-NM, B-NMD Construction en bronze.

P<sub>2</sub> Puissance nominale moteur.  
 H Hauteur totale en m.

● Avec moteur monophasé = NMM - NMDM.  
 \* Aspiration manométrique maximum 1-2 m.  
 Tolérances selon ISO 9906, annexe A.

### Courants nominaux

P <sub>1</sub> kW	P <sub>2</sub>		230 V 1~ IN A		IA/IN
	kW	HP	IN A	IA/IN	
0,62	0,37	0,5	3	2,7	
0,72	0,45	0,6	3,6	2,9	
0,91	0,55	0,75	4,5	3,1	
1,2	0,75	1	5,8	3	
1,6	1,1	1,5	7,4	3	
2	1,5	2	9,2	3,8	

  

P <sub>2</sub> kW	HP	230 V Δ / 400 V Y 400 V Δ / 690 V Y			IA/IN
		IN A	IN A	IN A	
0,37	0,5	2,3	1,3		3,8
0,45	0,6	2,3	1,3		3,5
0,55	0,75	3	1,7		4,3
0,75	1	4	2,3		5,2
1,1	1,5	5	2,9		5,3
1,5	2	7,5	4,3		5,8
2,2	3	9,15	5,3		6
3	4	11,5	6,6		9
4	5,5		9,6	5,5	9,3
5,5	7,5		12	7	8,3
7,5	10		16	9,2	8,8
9,2	12,5		20	11,5	10

P<sub>1</sub> Max. puissance absorbée.  
 P<sub>2</sub> Puissance nominale moteur.  
 IA/IN Courant au démarrage / Courant nominal



Courbes caractéristiques  $n \approx 2900$  1/min

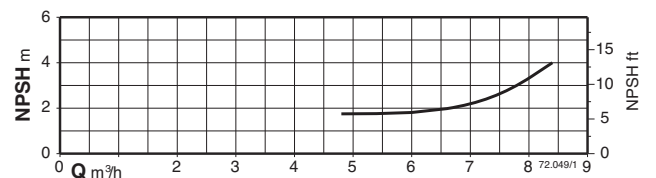
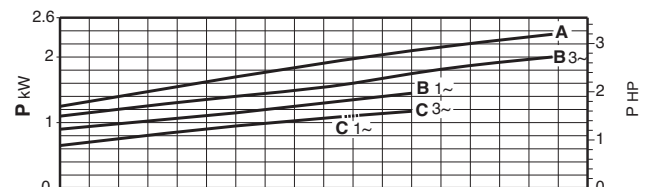
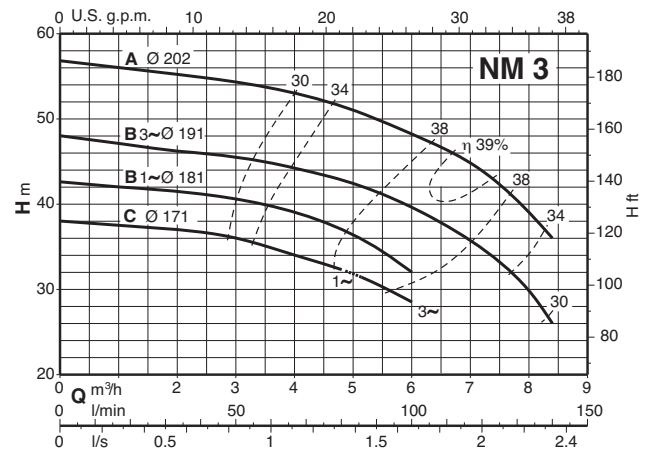
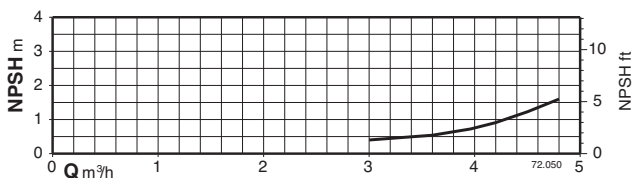
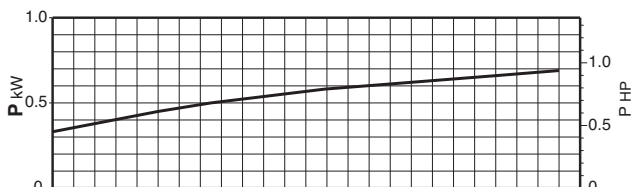
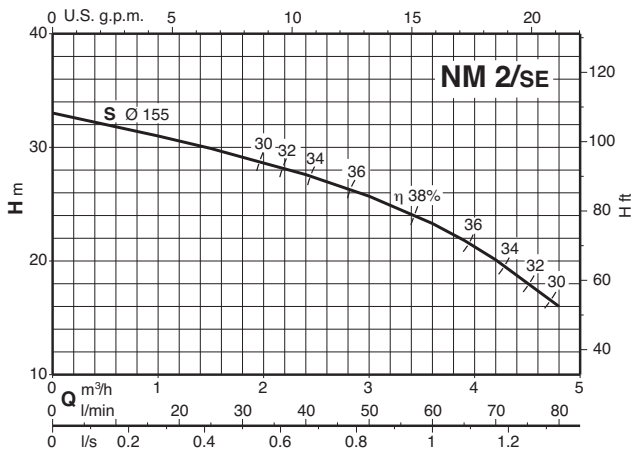
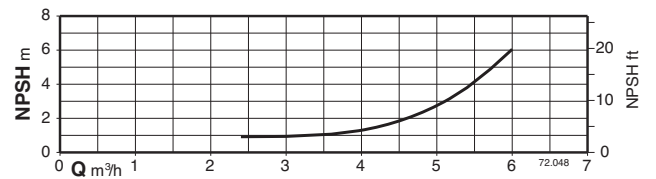
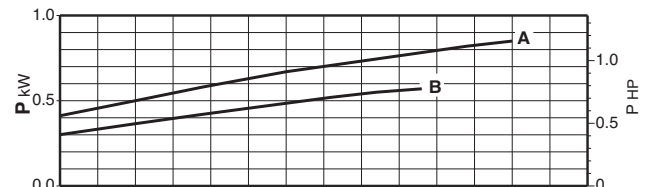
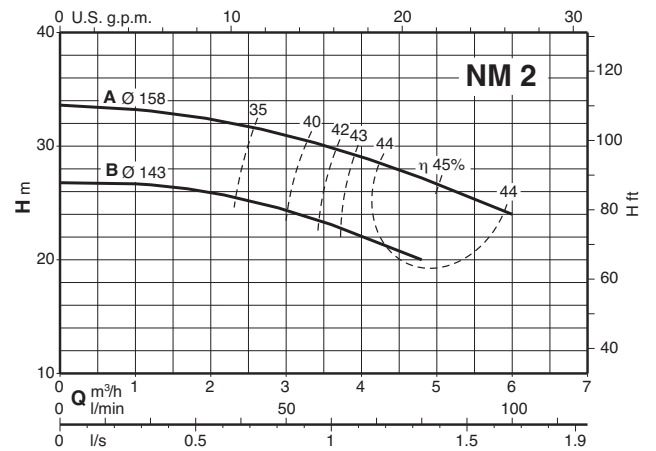
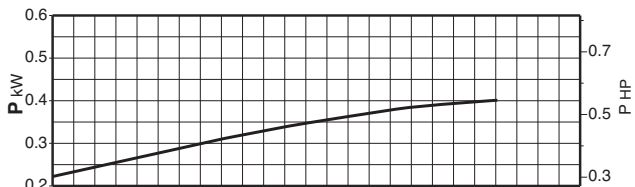
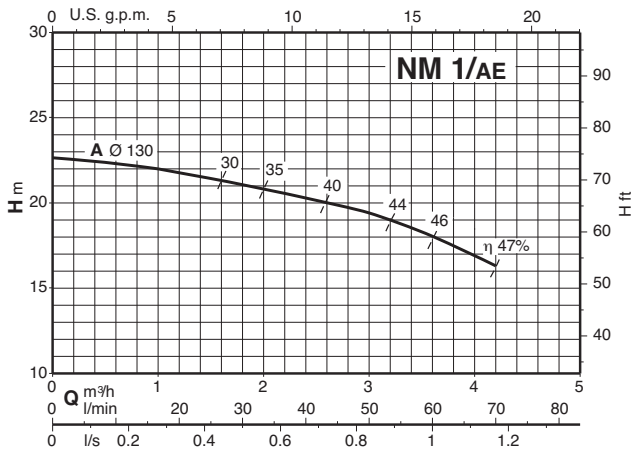

Courbes caractéristiques  $n \approx 2900$  1/min

1

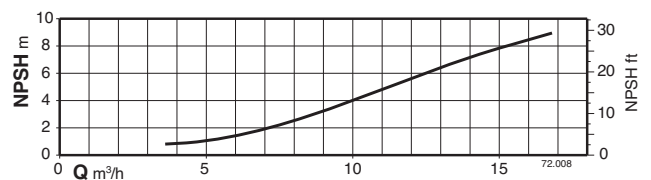
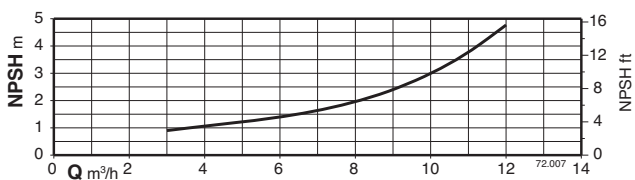
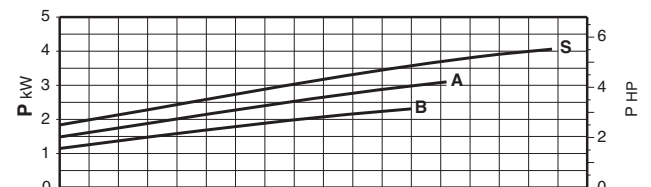
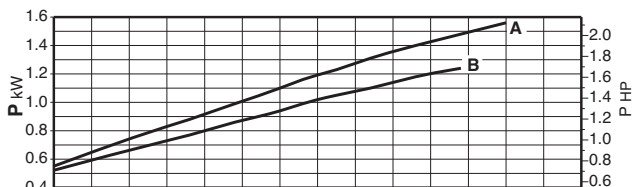
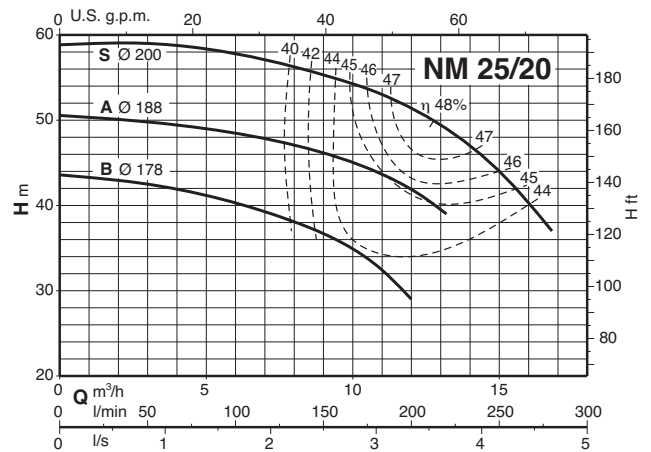
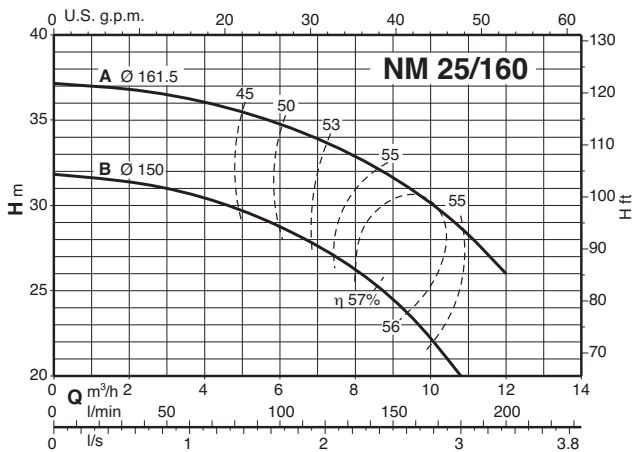
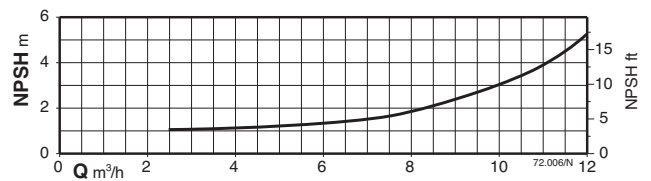
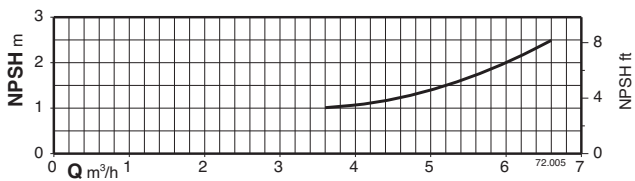
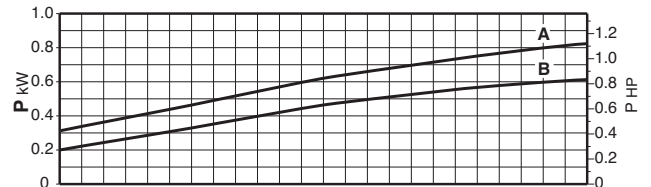
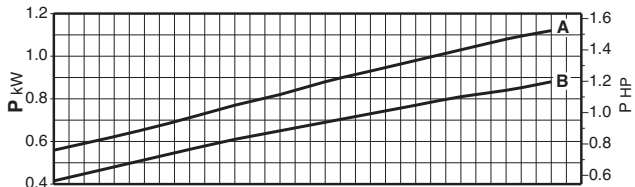
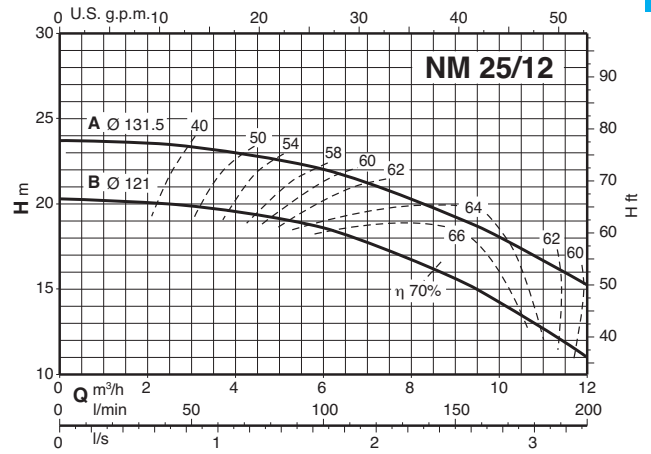
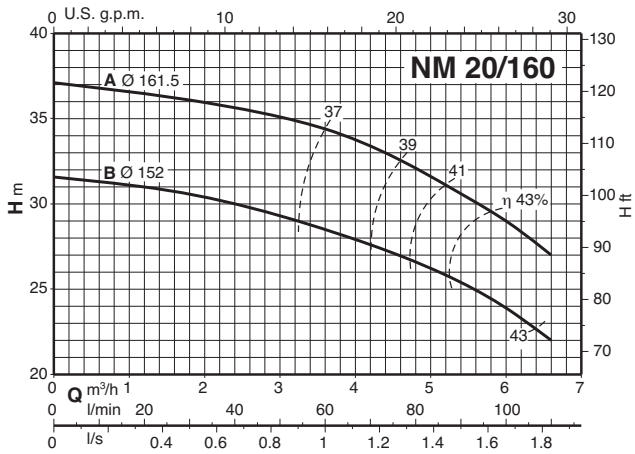



Courbes caractéristiques  $n \approx 2900$  1/min

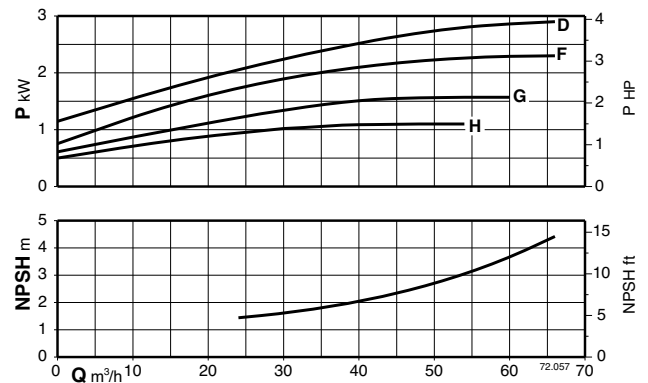
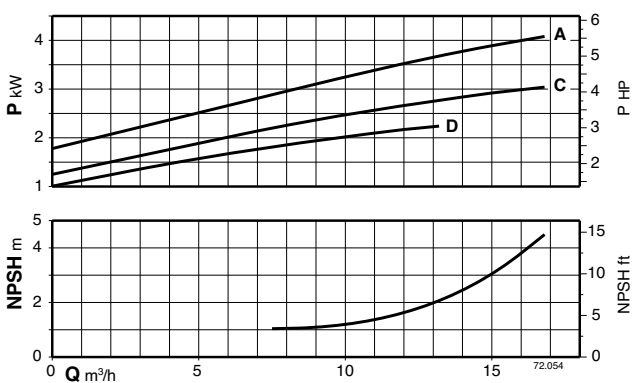
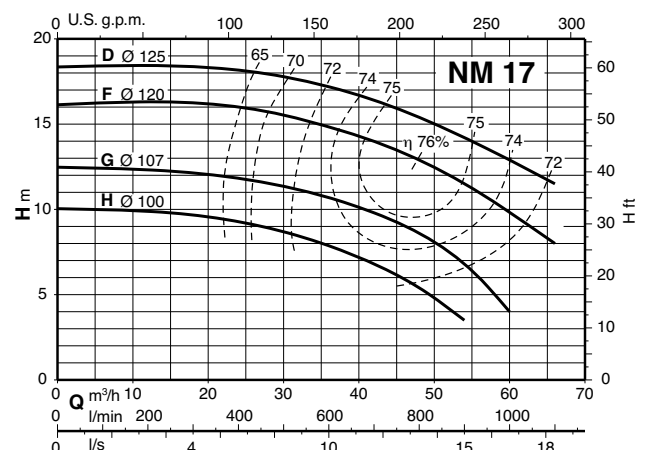
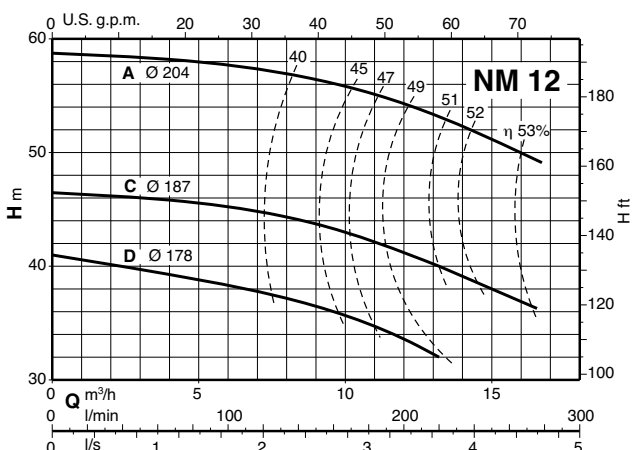
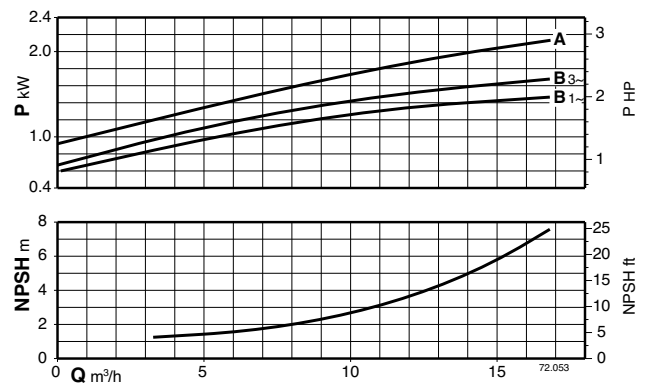
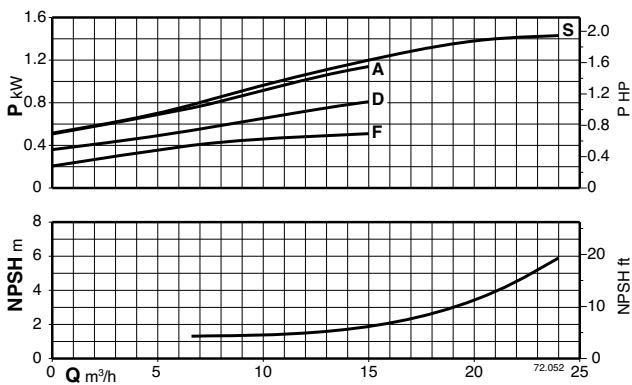
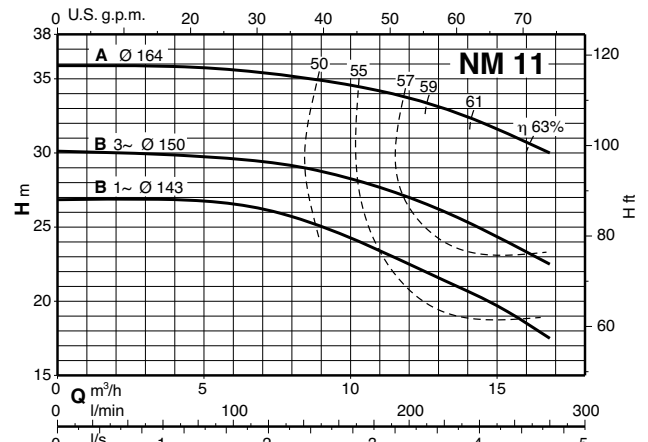
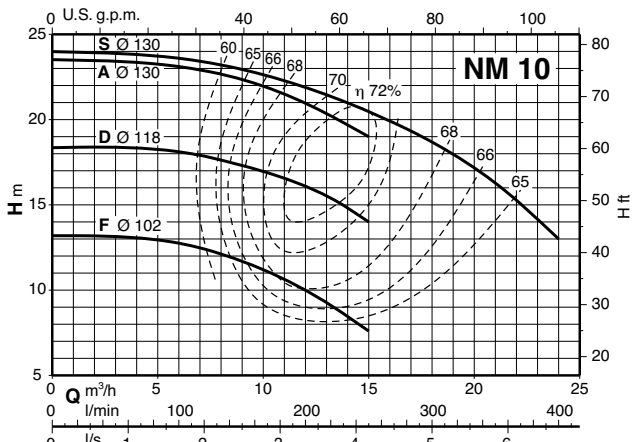

## Courbes caractéristiques $n \approx 2900$ 1/min

1

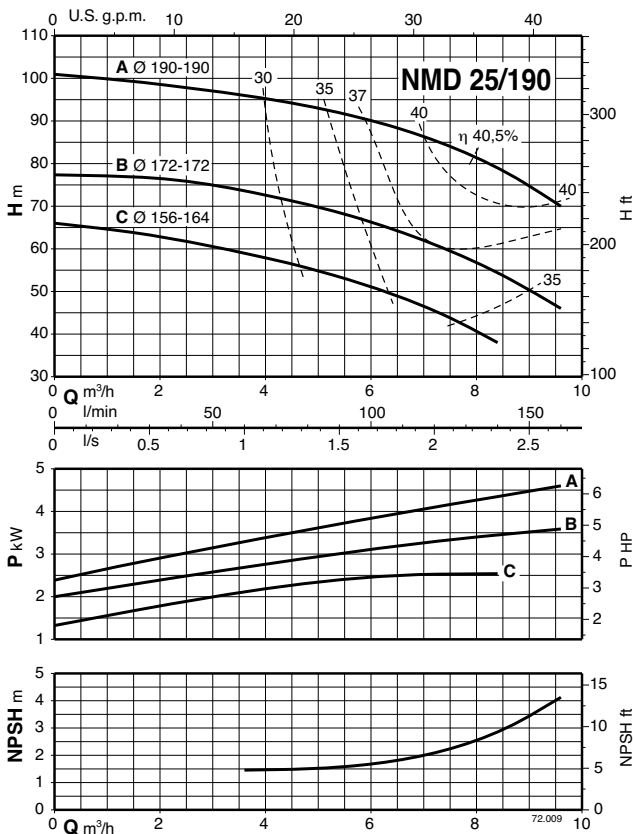
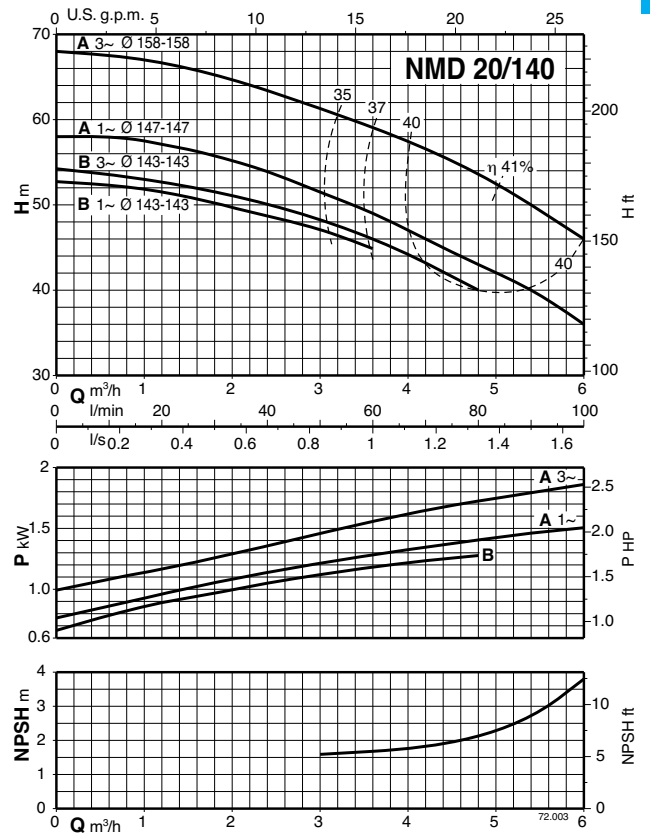
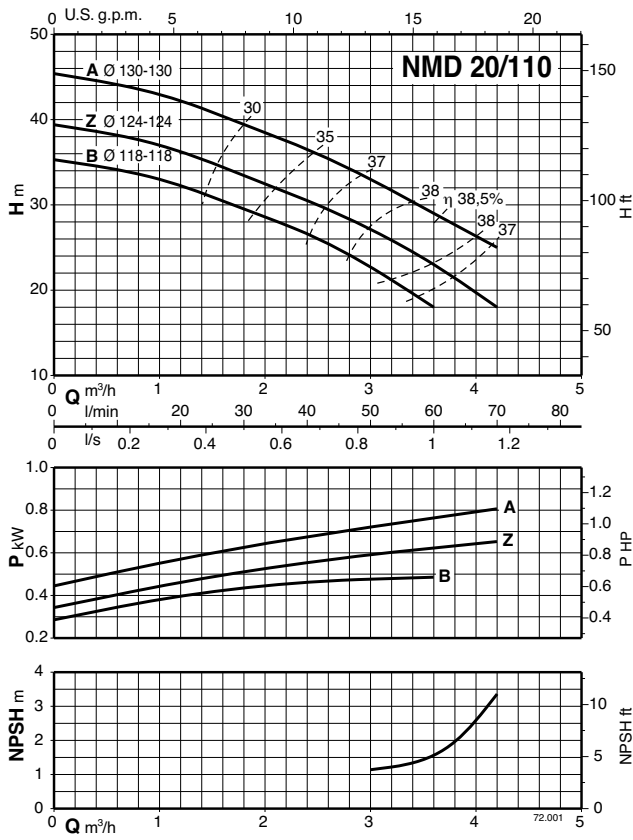

## Courbes caractéristiques $n \approx 2900$ 1/min

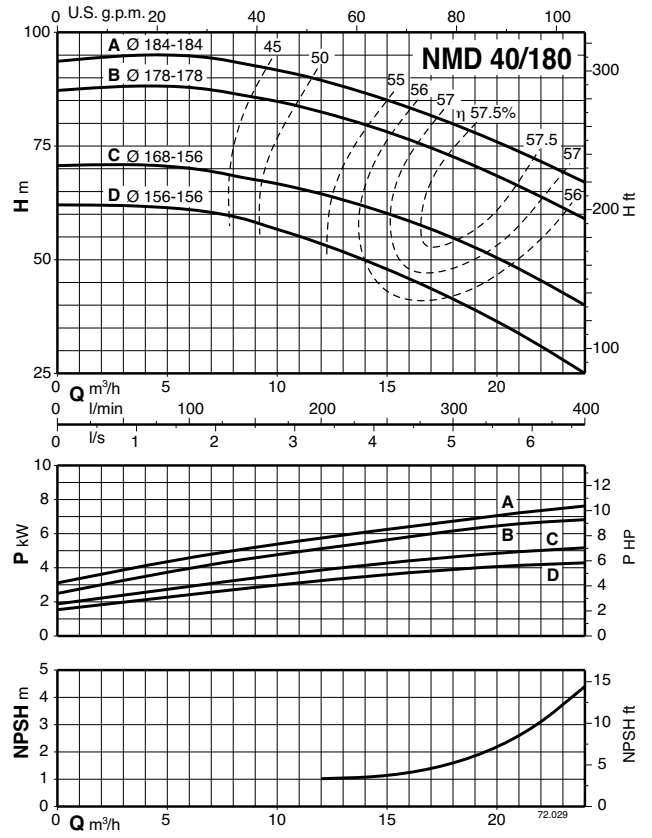
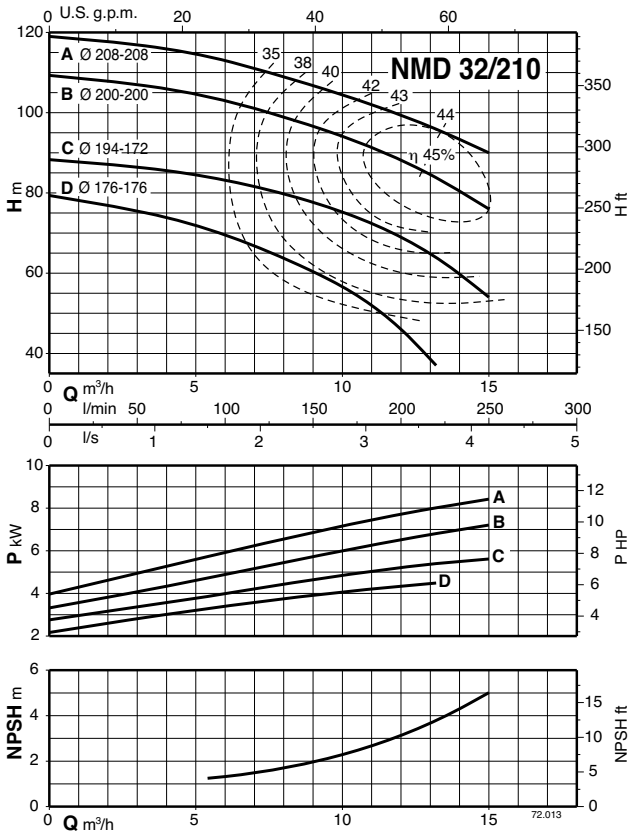



Dimensions et poids

1

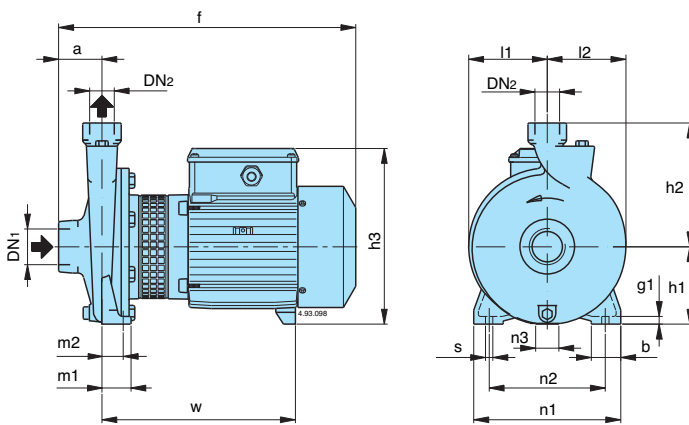

TYPE	NMM kg	NM kg	B-NM kg
NM 1/AE	8,7	8,6	
NM 2/BE	14	13,1	
NM 2/SE	14,2	13,3	
NM 2/AE	15,1	14,2	
NM 3/CE	24	22,9	
NM 3/BE	26	25,1	
NM 3/AE		26,1	
B- NM 20/160BE	19,9	18,4	21
B- NM 20/160AE	20,7	19,7	22,5
B- NM 25/12BE	13,2	12,3	13,5
B- NM 25/12AE	14,2	13,3	14,5
B- NM 25/160BE	20,4	19,7	22,8
B- NM 25/160AE	22,5	21,5	24
NM 25/20BE		28,6	
NM 25/20AE		37,9	
NM 25/20SE		41,7	
B- NM 25/200BE			32,7
B- NM 25/200AE			40,7
B- NM 25/200SE			44,7
NM 10/FE	19,3	18,5	
NM 10/DE	19,4	18,8	
NM 10/AE	20,2	19,3	
NM 10/SE	22,1	21,5	
NM 11/BE	24,7	24,1	
NM 11/AE		25,1	
NM 12/DE		30,5	
NM 12/CE		39	
NM 12/AE		43	
B- NM 17/HE	23	22,2	29,2
B- NM 17/GE	24,2	23,2	30,2
B- NM 17/FE		25,2	32,2
B- NM 17/DE		33,2	40,2

B-NM	NM	DN1 ISO 228	DN2 ISO 228	mm															
				a	f	h1	h2	h3	m1	m2	n1	n2	n3	b	s	l1	l2	w	g1
	NM 1/AE	G 1	G 1	40	261	80	132	176	40	32	170	140	17	35	9,5	77	81	171	10
	NM 2/AE-SE-BE	G 1	G 1	45	305	95	150	203	40	32	190	160	17	35	9,5	87	90	218	10
	NM 3/AE-BE-CE	G 1	G 1	50	375	112	180	240	55	43	245	205	37	45	11,5	110	113	244	12
	B- NM 20/160AE-BE	G 1 1/4	G 3/4	53	375	100	150	228	37,5	27,5	190	150	30	38	9,5	102	102	246	10
	B- NM 25/12AE-BE	G 1 1/2	G 1	56	313	90	140	195	37,5	27,5	170	130	9	38	9,5	85	88	195	10
	B- NM 25/160AE-BE	G 1 1/2	G 1	56	380	100	160	228	37,5	27,5	190	150	30	38	9,5	102	102	246	10
	NM 25/20BE	G 1 1/2	G 1	63	393	125	180	253	45	32,5	245	200	49	45	11,5	125	125	251	11
	NM 25/20AE-SE			63	460								42					295	
	B- NM 25/200BE	G 1 1/2	G 1	63	405	125	180	253	45	32,5	245	200	49	45	11,5	125	125	263	11
	B- NM 25/200AE-SE			63	460								42					295	
	NM 10/SE-AE-DE-FE	G 2	G 1 1/4	63	382	100	150	228	50	35	190	140	30	50	13	90	97	239	14
	NM 11/AE-BE	G 2	G 1 1/4	70	400	112	170	240	50	35	210	160	37	50	15	103	110	247	14
	NM 12/DE			70	400	132	190	260	50	35	240	190	47	50	15	125	127	247	14
	NM 12/AE-CE			70	470								45					300	
	B- NM 17/FE- GE-HE	G 2 1/2	G 2 1/2	80	417	112	160	240	50	35	210	160	37	50	14	96	113	257	14
	B- NM 17/DE			80	480								20					295	

## Dimensions et poids

### NMD 20/110

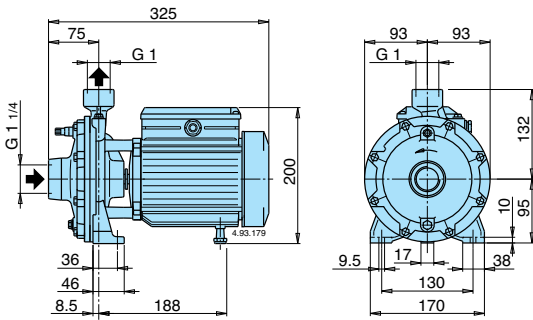

TYPE	NMDM kg	NMD kg	B-NMD kg
B- NMD 20/110BE	13	12,1	13,4
B- NMD 20/110ZE	14	13	14,2
B- NMD 20/110AE	15,1	14,2	17,4

### NMD 20/140 NMD 25/190

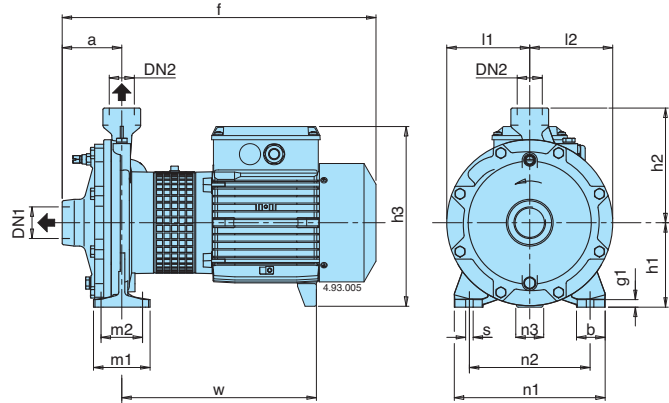

TYPE	NMDM kg	NMD kg	B-NMD kg
B- NMD 20/140BE	23,9	22,7	25,2
B- NMD 20/140AE	25,2	24,8	27,6
B- NMD 25/190CE		39	42,7
B- NMD 25/190BE		46,7	51
B- NMD 25/190AE		51	55

B-NMD	NMD	DN1	DN2	mm															
				ISO 228		a	f	h1	h2	h3	m1	m2	n1	n2	n3	b	s	l1	l2
B-NMD 20/140AE-BE	NMD 20/140AE-BE	G 1 1/4	G 1	80	410	112	150	243	75	55	200	160	37	38	9,5	110	110	256	10
B-NMD 25/190CE	NMD 25/190CE				447								50					274	
B-NMD 25/190BE	NMD 25/190BE	G 1 1/2	G 1	97	500	140	180	268	100	70	240	190	49	50	14	133	133	306	13
B-NMD 25/190AE	NMD 25/190AE				500								49					306	

### NMD 32/210 NMD 40/180

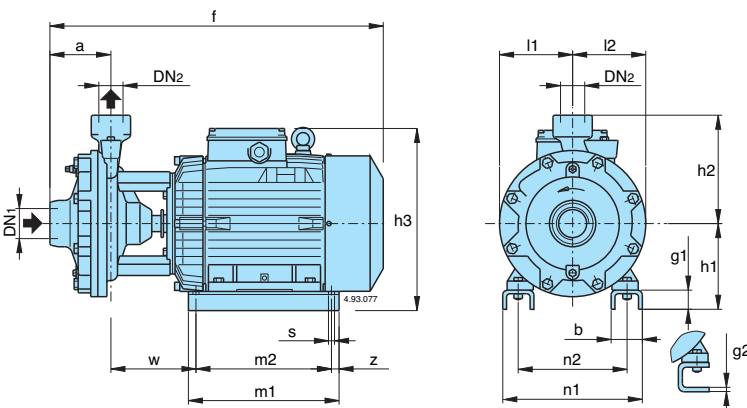

TYPE	NMD kg	B-NMD kg
B- NMD 32/210DE	60	66
B- NMD 32/210CE	70	76
B- NMD 32/210BE	76,5	82
B- NMD 32/210AE	99	105
B- NMD 40/180DE	59	65
B- NMD 40/180CE	69	75
B- NMD 40/180BE	75,5	81
B- NMD 40/180AE	97	102

B-NMD	NMD	DN1	DN2	mm																		
				ISO 228		a	f	h1	h2	h3	m1	m2	n1	n2	z	b	s	l	l1	l2	w	g1
B- NMD 32/210DE	NMD 32/210DE	G 2	G 1 1/4	110	530	155	215	283	205	175	194	140	15	54	10	-	-	150	150	139	-	6
B- NMD 32/210BE-CE	NMD 32/210BE-CE				625	170		310	280	250	258	190	15	68	12	-	-	150	150	108	38	-
B- NMD 32/210AE	NMD 32/210AE				550	170		355	298	268	286	216		70	12	-	-			152	38	-
B- NMD 40/180DE	NMD 40/180DE	G 2	G 1 1/2	121	535	155	215	283	205	175	194	140	15	54	10	-	-	145	145	133	-	6
B- NMD 40/180BE-CE	NMD 40/180BE-CE				630	170		310	280	250	258	190	15	68	12	-	-	145	145	102	38	-
B- NMD 40/180AE	NMD 40/180AE				630	170		355	298	268	286	216		70	12	-	-			145	38	-