



motralec

4 rue Lavoisier . ZA Lavoisier . 95223 HERBLAY CEDEX
Tel. : 01.39.97.65.10 / Fax. : 01.39.97.68.48
Demande de prix / e.mail : service-commercial@motralec.com
www.motralec.com

COMPANY
WITH QUALITY SYSTEM
CERTIFIED BY DNV
=ISO 9001/2000=

Water technology at your service

DRN - DGN - GRN - APN - MAN

Electropompes submergées avec roue mobile de type **bicanal ouverte, vortex**, avec **système de broyage**, à **grande hauteur manométrique** et **monocanal ouverte**

Electrobombas con impulsor doble canal abierto, vortex, con sistema de trituración, con grande altura manometrica y monocanal abierto

- Indiquées pour eaux chargées d'origine civile et industrielle
Adecuada para aguas cargadas de origen civil y industrial
- Puissance de 1,1 à 4,1 kW, 2, 4 et 6 poles
Potencia de 1,1 a 4,1 kW, 2, 4 y 6 polos
- Prédiposition pour système de refroidissement
Preparada para el montaje del sistema de refrigeración
- Large passage libre
Amplio paso libre



50 Hz

DRN - DGN - GRN - APN - MAN

Electropompes submergées avec roue mobile de type **bicanal ouverte, vortex**, avec **système de broyage**, à **grande hauteur manométrique** et **monocanal ouverte**

*Electrobombas con impulsor **doble canal abierto, vortex**, con **sistema de trituración**, con **grande altura manométrica** y **monocanal abierto***

Electropompes industrielles projetées avec des nouveaux paramètres mécaniques et électriques pour améliorer l'efficacité et la fiabilité

Electrobombas diseñadas con nuevas características mecánicas y eléctricas al fin de aumentar el rendimiento y la fiabilidad

Double câble électrique d'alimentation

Longueur standard 10 m

Cable eléctrico doble de alimentación

Longitud estándar de 10 m

Carcasse

en fonte GJL-250. Protection IP68

Carcasa

de fundición GJL-250. Protección IP68

Sonde d'étanchéité chambre à huile

Sonda de integridad del aceite

Arbre moteur

accouplé à la roue par un joint conique

Eje

con acoplamiento al impulsor mediante una junta cónica

Entretien facilité

De particulières astuces de conception facilitent les opérations d'entretien

Facilidad de mantenimiento

Dispositivos de fabricación especiales facilitan las operaciones de mantenimiento

Presse-câble

avec filetage GAZ, prééglé pour canaliser le câble

Sujetacable

con roscado GAS, adecuado para introducir el cable

Roulements

Ils sont protégés et lubrifiés à vie et dimensionnés pour assurer 20 000 heures de fonctionnement

Rodamientos

Blindados y con lubricación permanente, de dimensiones adecuadas para garantizar 20.000 horas de funcionamiento

Garnitures mécaniques opposées

L'accès à la chambre se fait par moyen d'une boucle démontable

Cierres mecánicas en posición opuesta

Un casquillo apretado con llave de sector para acceder a la cámara de las juntas

**BREVETÉ
PATENTADO**

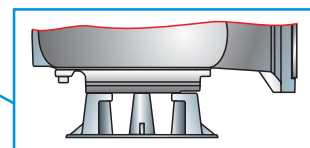
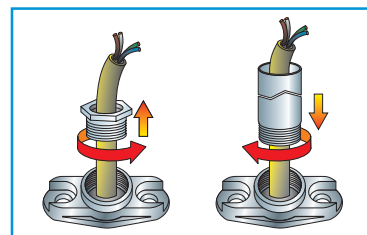
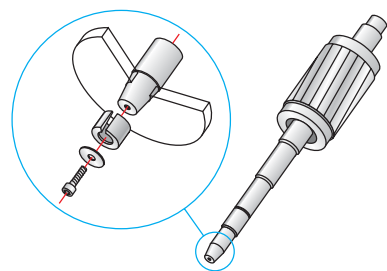

Bride d'aspiration

Avec perçage PN6, prééglée pour le montage sur l'embase en fonte

Brida de aspiración

Con perforación PN6, preparada para el montaje en base de fundición



DRENO (DR)

Page
Página 5

Roue mobile multicanal ouverte à haut rendement
Indiquée pour des utilisations poussées en milieu civil et industriel

*Impulsor multicanal abierta de alto rendimiento
Indicada para trabajos pesados en entornos civiles e industriales*

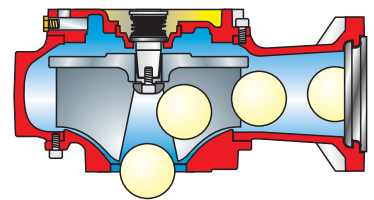

40 ÷ 100 mm

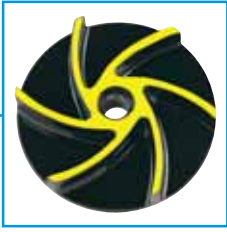

DRAGA (DG)

Page
Página 10

Roue mobile reculée de type **VORTEX** qui assure de larges passages libres et même intégraux

*Impulsor retrocedido tipo **VORTEX** que garantiza amplios pasos libres, incluso integrales*

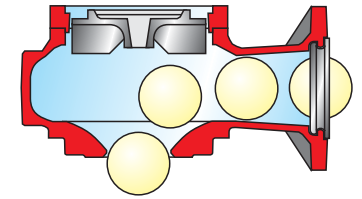

65 ÷ 150 mm



GRINDER (GR)

Page
Página 16

Le **SISTEME DE BROYAGE** est formé d'un disque et un couteau triangulaire en acier INOX d'une excellente résistance pouvant hacher finement des corps solides et filamenteux

*El **SISTEMA DE TRITURACION** está compuesto por un disco y una cuchilla triangular de acero INOX de alta resistencia que puede triturar de forma fina cuerpos sólidos y filamentosos*

Version 2 pôles
Versión de 2 polos

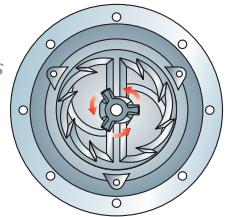
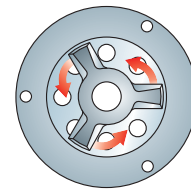

Version 4 pôles
Versión de 4 polos



Alta Prevalenza (AP)

Page
Página 19

Roue mobile à grande **HAUTEUR MANOMETRIQUE**.
Un usinage particulier, sur l'arrière ou sur le côté de la roue mobile, garantit la lacération des petits corps

*Impulsor de **GRANDE ALTURA MANOMETRICA**.
Una especial mecanización en la parte trasera o en el costado del rotor asegura la laceración de cuerpos pequeños*

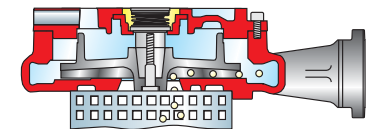

10 mm



MACS (MA)

Page
Página 21

Roue **MONOCANAL OUVERTE**
La conformation particulière de la palette de la roue mobile et le sillon gravé sur le pied de support, assurent l'expulsion des petits corps en leur offrant ainsi une voie d'issue

*Impulsor de **UN CANAL ABIERTO**
La particular conformación de la pala del impulsor y el surco grabado en el pie de soporte garantizan la expulsión de pequeños cuerpos sólidos dándoles una vía de fuga*

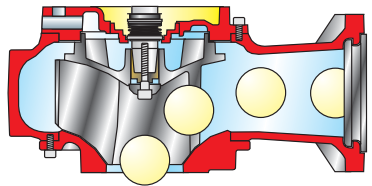

40 ÷ 100 mm



Anti-Clogging System

Dans la partie arrière, la roue est dotée d'un dispositif empêchant aux corps solides en suspension d'atteindre et endommager garniture mécanique plus extérieur.

En la parte posterior, el impulsor está dotado de un sistema que impide que los cuerpos sólidos en suspensión alcancen y dañen el cierre mecánico más exterior.

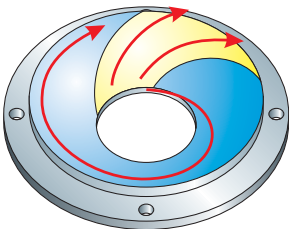
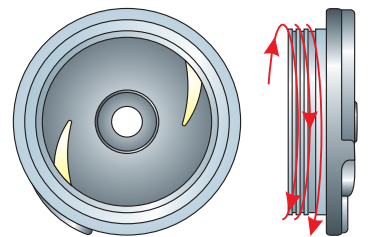

Le système anticlogmatage (**ACS=Anti Clogging System**) assure le déchirement des fibres. En outre, des solutions de construction particulière permettent d'augmenter le débit d'eau à l'intérieur du circuit de refroidissement, tout en assurant le refroidissement correct du moteur dans les cas d'installation à sec.

*El sistema antibloqueo (**ACS=Anti Clogging System**) asegura la trituración de las fibras. Además, técnicas de construcción particulares permiten aumentar el caudal de agua en el interior del circuito de refrigeración, garantizando una eficiente refrigeración del motor en los casos de instalación en seco.*

Système de refroidissement

Sistema de refrigeración

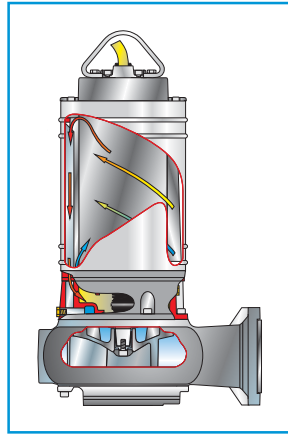

Disponible avec **système de refroidissement** par liquide traité ou par un circuit extérieur ou possibilité de fluxage des dispositifs d'étanchéité.
De nouvelles astuces de construction permettent d'effectuer l'entretien de la chemise de refroidissement sans agir sur le moteur et sur le câble d'alimentation.

Disponible con **sistema de refrigeración** mediante líquido tratado o desde un circuito externo y con la posibilidad de fluidificación de las juntas de estanqueidad.
Nuevas técnicas de fabricación permiten efectuar el mantenimiento de la camisa de enfriamiento sin intervenir en el motor y en el cable de alimentación.

Matériels de construction

Materiales de construcción

Ensemble mécanique	Fonte EN-GJL-250
Arbre	Acier X30Cr13 (AISI420)
Joints (O-Ring)	Caoutchouc NBR-SBR
Chemise de refroidissement(*)	AISI 304
Roue	Fonte EN-GJL-250
Visserie	Acier INOX A2
Peinture	Epoxy-vinylrique écologique
Garnitures mécaniques(**)	carbure de silice/ graphite alumine

Conjunto mecánico	Fundición EN-GJL-250
Eje	Acero X30Cr13 (AISI420)
Juntas (O-Ring)	Goma NBR-SBR
Cámara de refrigeración(*)	AISI 304
Impulsor	Fundición EN-GJL-250
Tornillos	Acero INOX A2
Pintura	Epoxivinílica ecológica
Cierres mecánicos(**)	carburo de silicio/ grafito alumina

(*): Option *optional*

(**): Sur demande, double garniture en carbure de silice *Bajo pedido, 2 cierres mecánicos en carburo de silicio*

Limites d'utilisation

Límites de uso

Temp. d'utilisation maxi	60 °C
PH liquide	de 6 à 10
Viscosité liquide	1 mm ² /s
Service	S3 25% standard - S3 15% ATEX
Prof. immersion maxi	20 m
Densité liquide	1 kg/dm ³
Press. acoustique maxi	< 70 dB dB
Démarrages/heure maxi	10

Temp. de uso máx.	60 °C
PH del líquido	de 6 a 10
Viscosidad del líquido	1 mm ² /s
Servicio	S3 25% standard - S3 15% ATEX
Prof. de inmersión máx	20 m
Densidad del líquido	1 kg/dm ³
Pres. acústica máx	< 70 dB dB
Arranques / hora máx	10

Disponible en version antidéflagrante suivant la norme **ATEX**

Disponible en version antidéflagrante cumpliendo con la normativa **ATEX**

CE 0496 Ex II 2 GD EEx d kc IIB T4 T135°C IP68 X

Possibilité d'installation dans une atmosphère et en présence de poussière explosibles
Posibilidad de instalación en lugares con atmósferas y polvos potencialmente explosivos

Directives: ATEX: 94/9/CE

Machines: 98/37/CE

Compatibilité électromagnétique: 89/336/CEE

Principales normes appliquées: EN 1127-1; EN 13463-1; EN 13463-5; EN 13463-8; EN 50014; EN 50018; EN 50281-1; EN 292-1; EN 292-2; EN 1050; EN 414; EN 60529; EN 60034-1; EN 60034-2; EN 60335-1; EN 60335-2-41; EN 9906; EN 60204-1; EN 1561; EN 1563; EN 614.

Procédures de certification : - examen CE du type (annexe III directive 94/09/CE), numéro KEMA 04 ATEX2231X délivré par l'Organisme de Notification KEMA Quality B.V. n° 0344 Utrechtseweg 310 NL-6812 AR Arnhem Netherlands; - garantie de qualité des produits

Directivas: ATEX: 94/9/CE

Máquinas: 98/37/CE

Compatibilidad electromagnética: 89/336/CEE

Principales normas aplicadas: EN 1127-1; EN 13463-1; EN 13463-5; EN 13463-8; EN 50014; EN 50018; EN 50281-1; EN 292-1; EN 292-2; EN 1050; EN 414; EN 60529; EN 60034-1; EN 60034-2; EN 60335-1; EN 60335-2-41; EN 9906; EN 60204-1; EN 1561; EN 1563; EN 614.

Procedimientos de certificación: - examen CE de tipo (anexo III directiva 94/09/CE) con número KEMA 04 ATEX2231X emitido por el Organismo Notificado KEMA Quality B.V. n. 0344 Utrechtseweg 310 NL-6812 AR Arnhem Netherlands; - garantía de calidad de los productos

Modèles DRENO (DRN)

Modelos DRENO (DRN)

Roue mobile multicanal ouverte à haut rendement
 Impulsor multicanal abierta de alto rendimiento

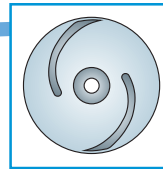

Regroupements de courbes hydrauliques

Conjuntos de curvas hidráulicas

REGROUPEMENT
CONJUNTO

A

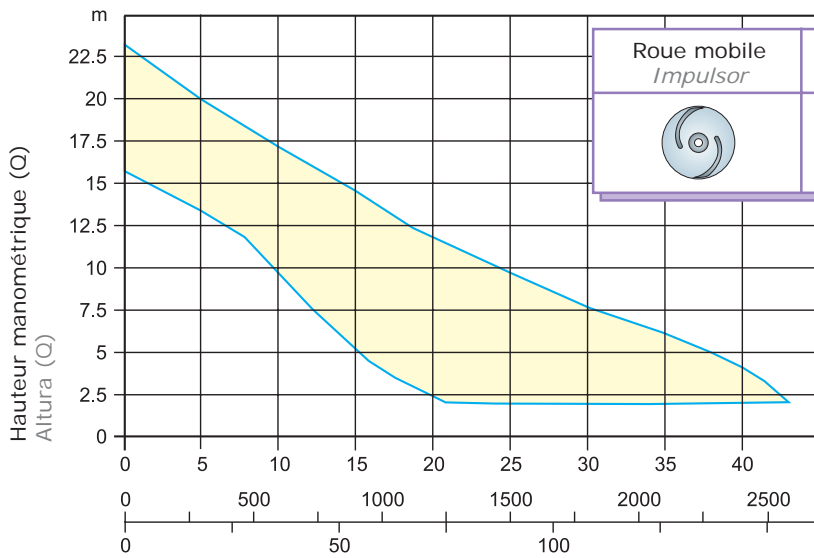

Roue mobile Impulsor	kW kW	Poles Polos	Ø Refoulement(mm) Ø Salida(mm)
	1.8 ÷ 4.1	2	65 ÷ 100

REGROUPEMENT
CONJUNTO

B

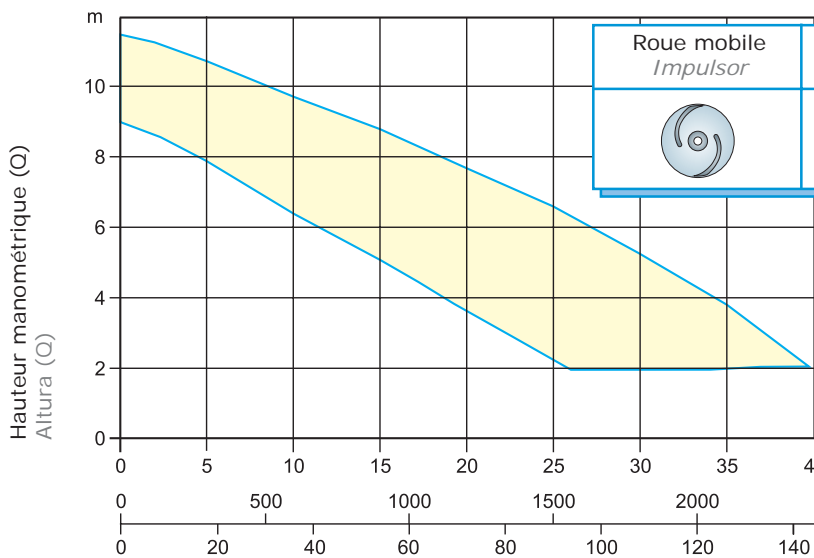

Roue mobile Impulsor	kW kW	Poles Polos	Ø Refoulement(mm) Ø Salida(mm)
	1.5 ÷ 3.0	4	80 ÷ 100

REGROUPEMENT
CONJUNTO

C

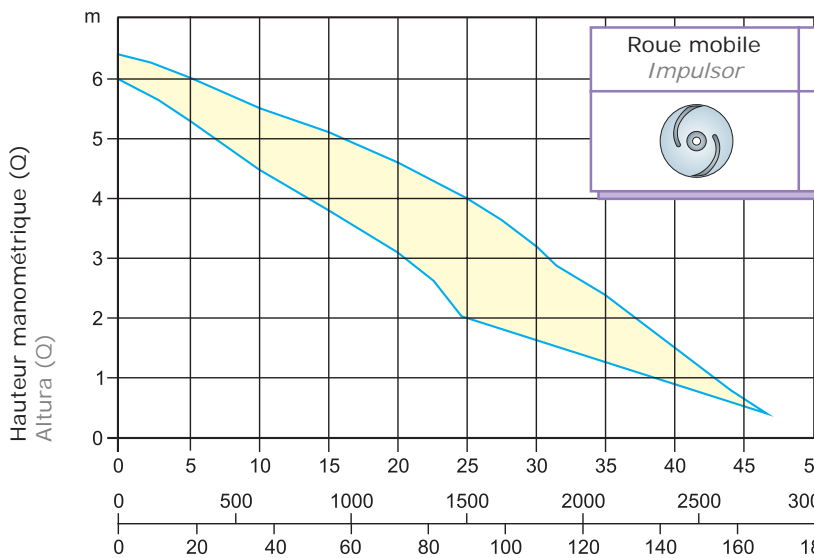

Roue mobile Impulsor	kW kW	Poles Polos	Ø Refoulement(mm) Ø Salida(mm)
	1.1 ÷ 1.8	6	80 ÷ 150

Courbes hydrauliques - DRN

Curvas hidráulicas - DRN

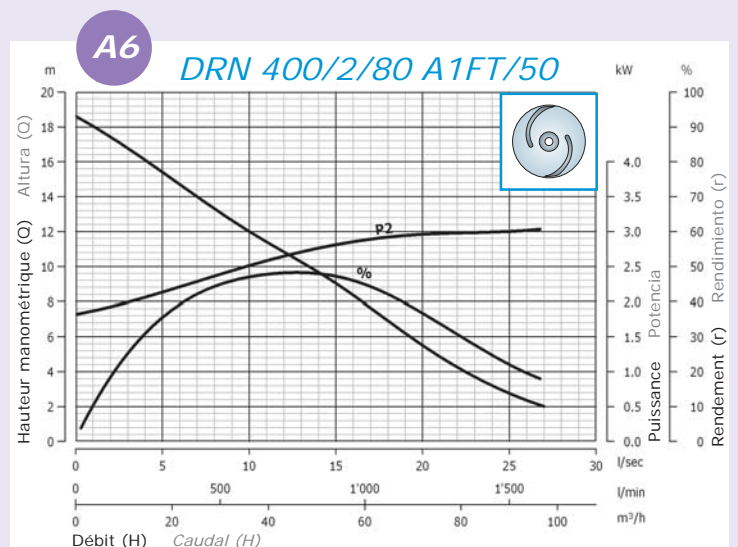
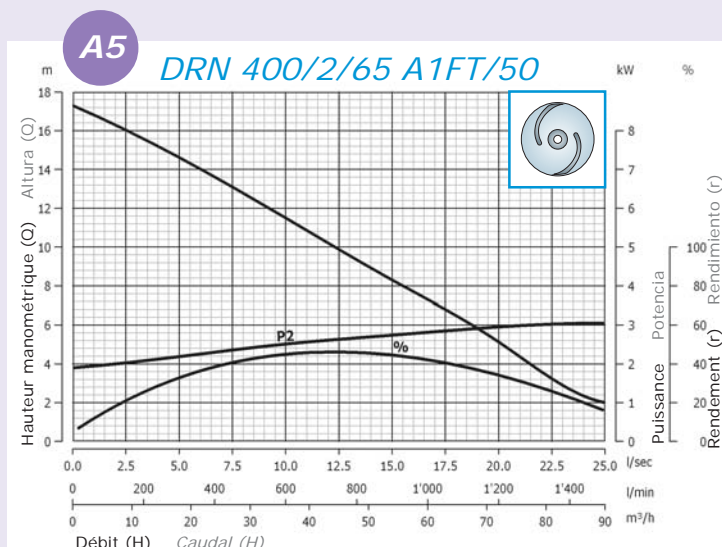
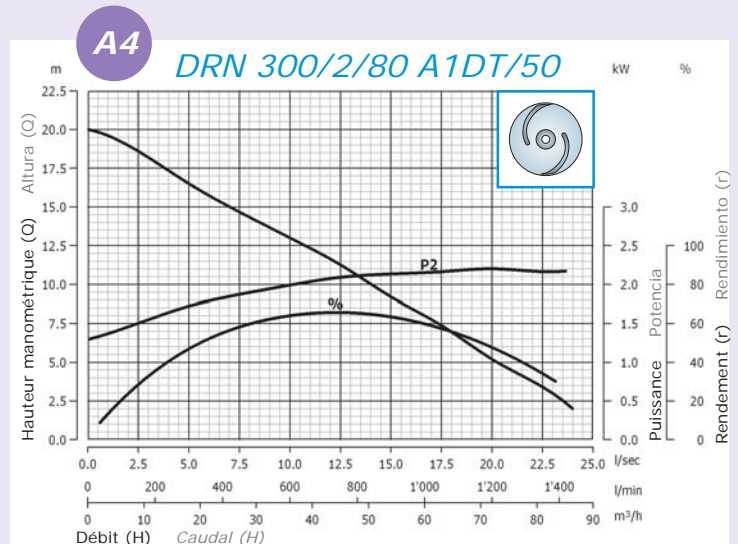
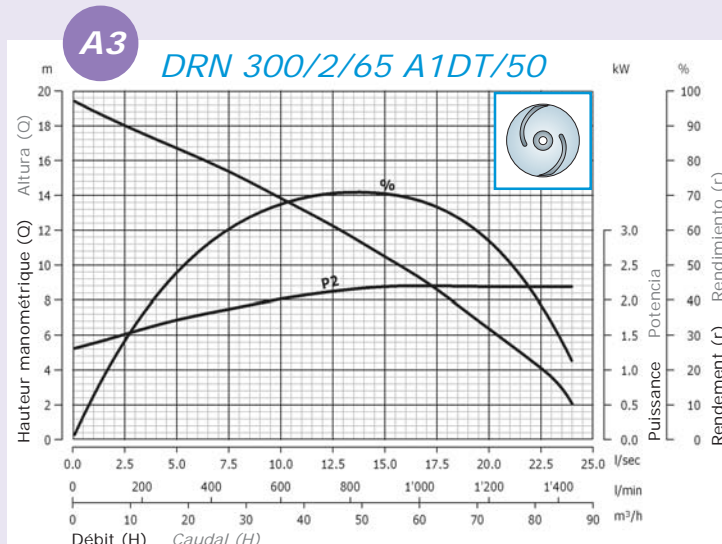
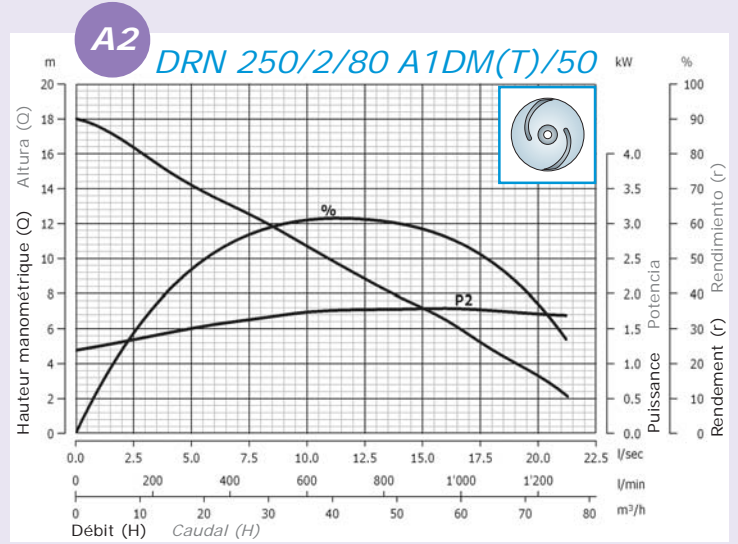
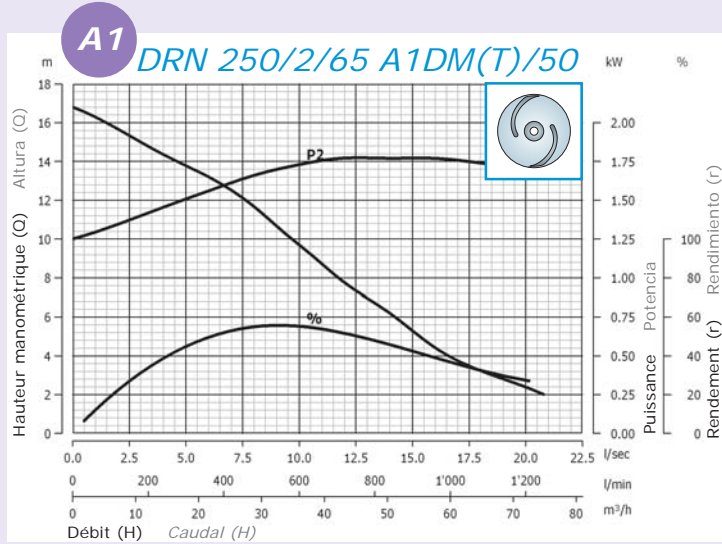

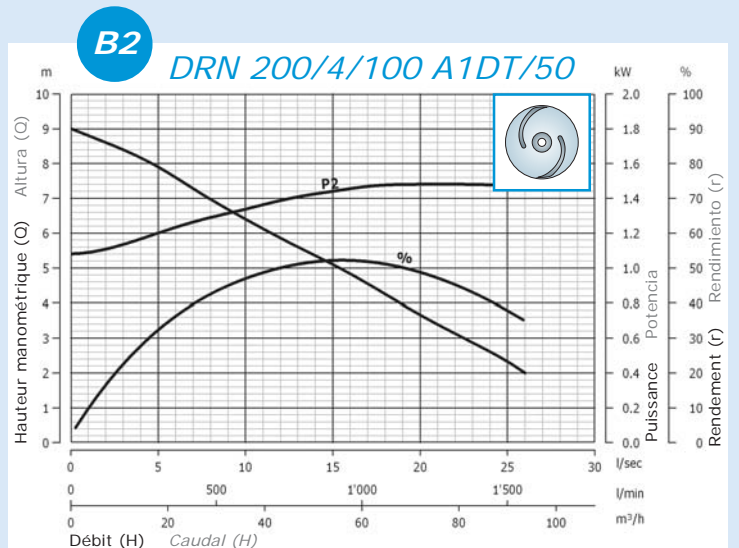
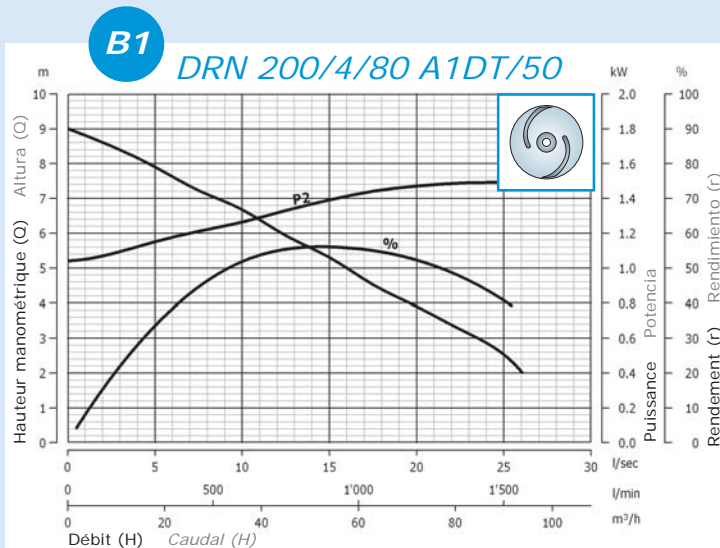
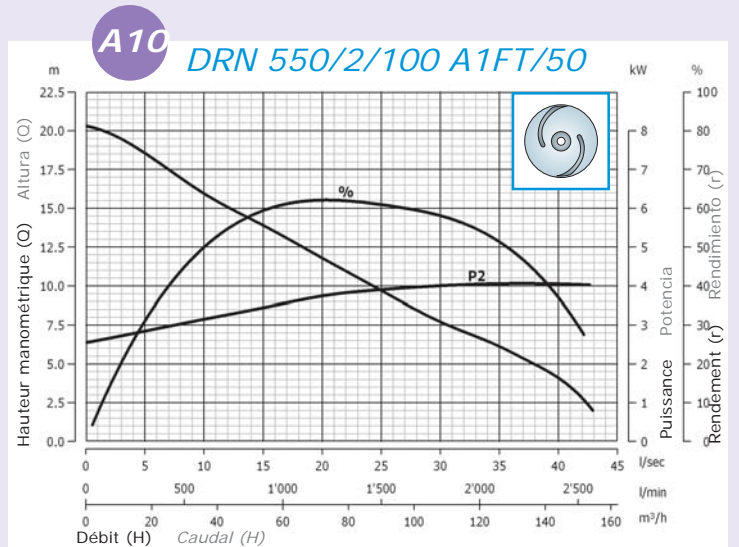
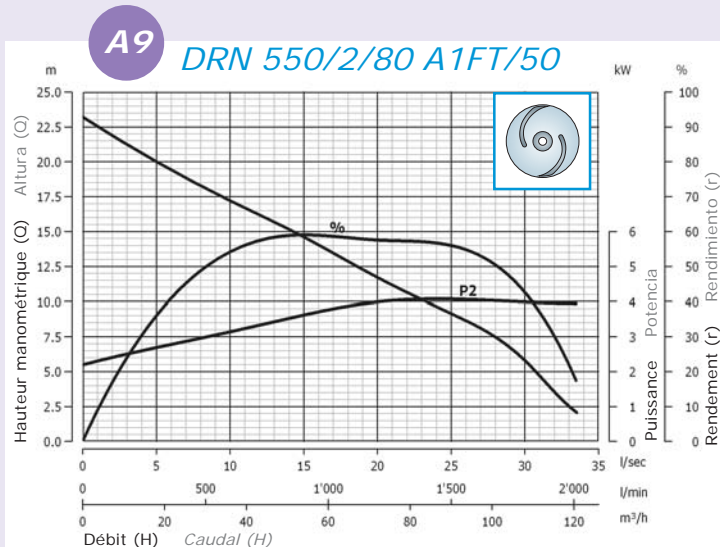
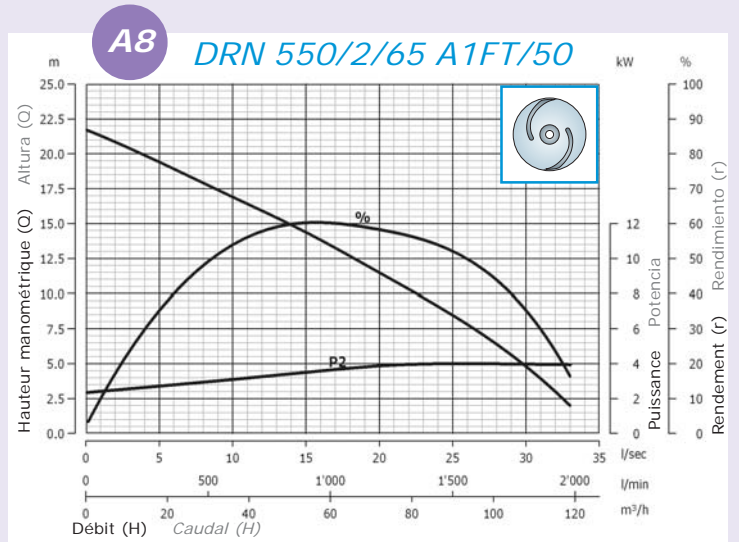
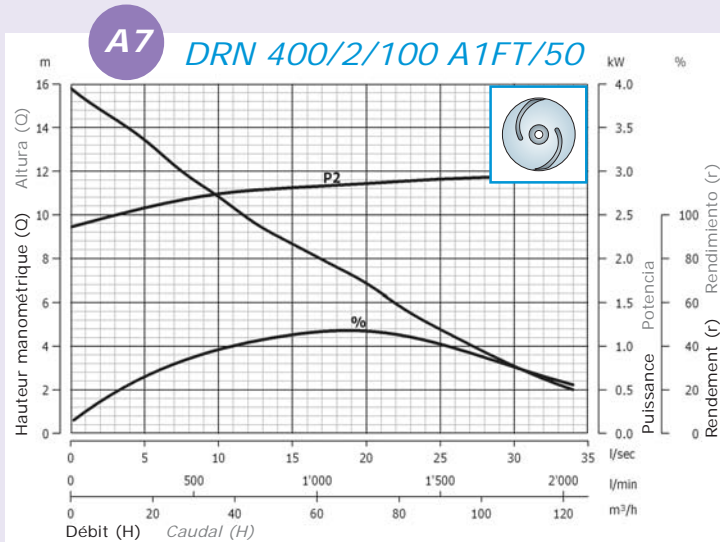

B3 DRN 300/4/80 A1FT/50

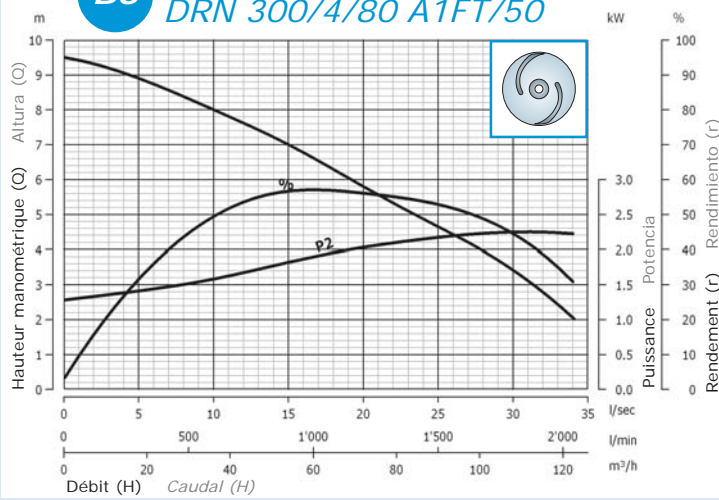

B4 DRN 300/4/100 A1FT/50

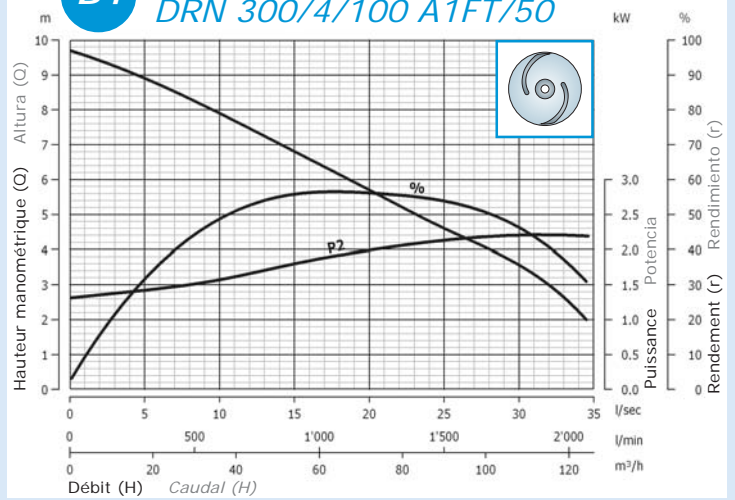

B5 DRN 400/4/80 A1FT/50

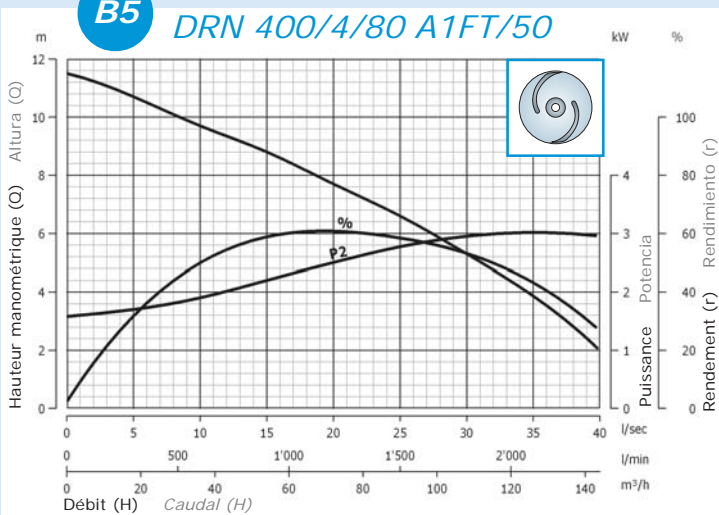

B6 DRN 400/4/100 A1FT/50

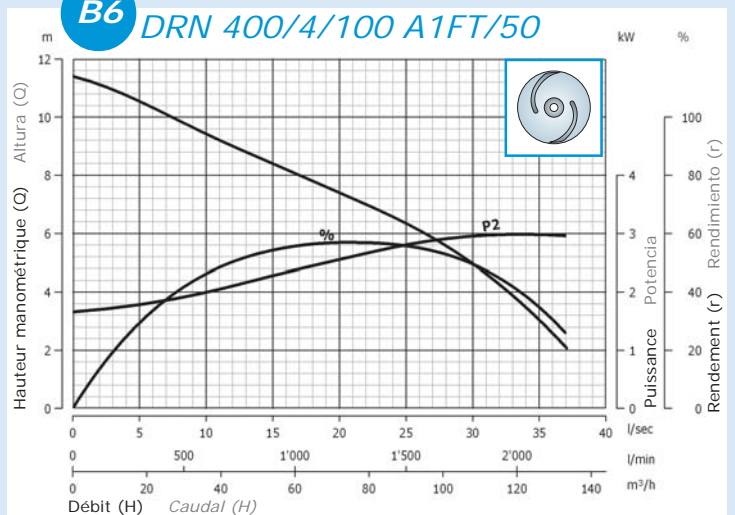

C1 DRN 150/6/80 A1DT/50

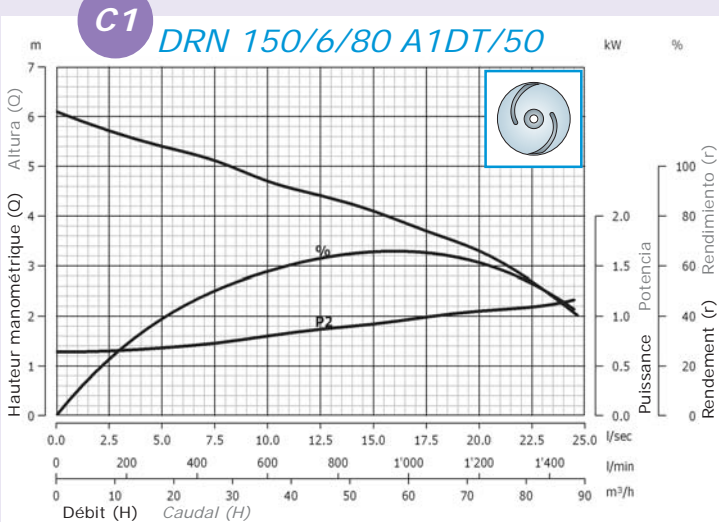

C2 DRN 150/6/100 A1DT/50

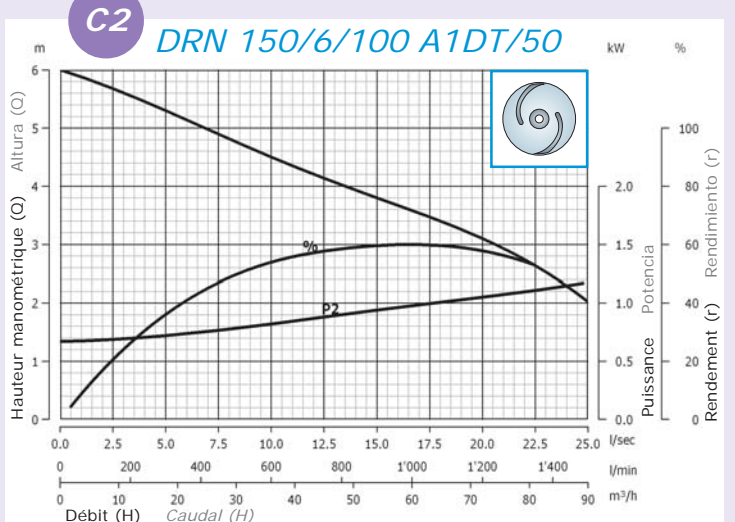

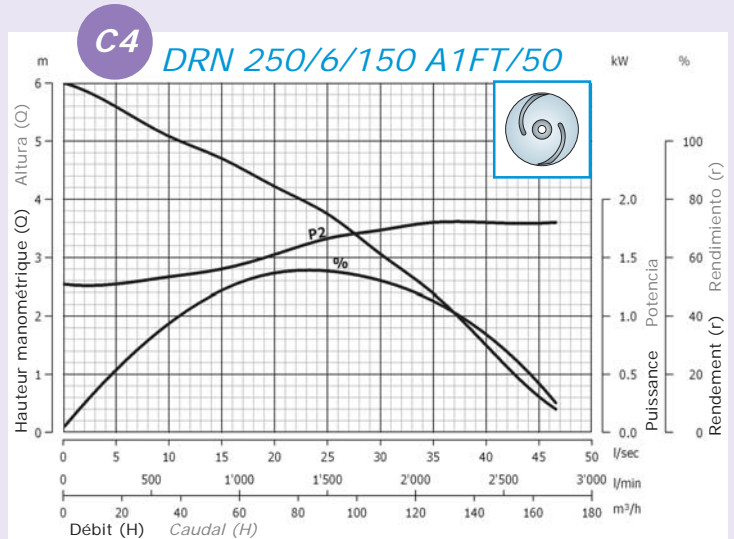
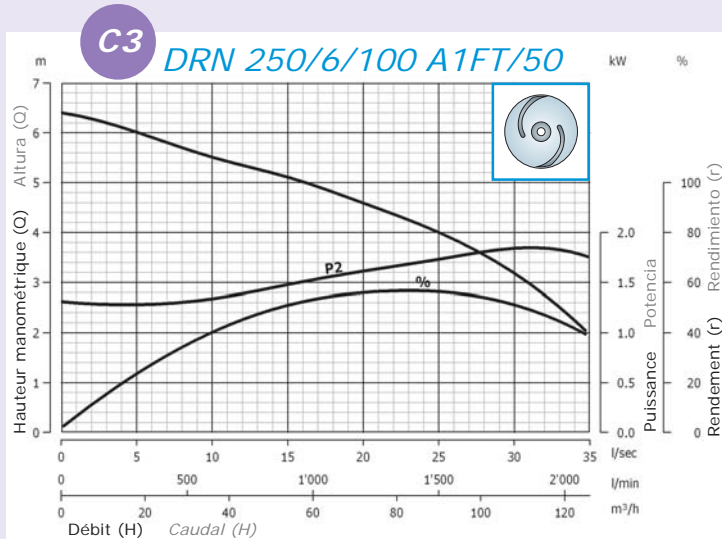

Données hydrauliques - DRN

Datos hidráulicos - DRN

		0	3	6	9	12	15	18	21	24	27	30	35	40	42
	l/min	0	180	360	540	720	900	1080	1260	1440	1620	1800	2100	2400	2520
	m³/h	0	10.8	21.6	32.4	43.2	54	64.8	7.6	86.4	97.2	108.0	126.0	144	151.2
A1	DRN 250/2/65 A1DM(T)	16.8	15	13.2	10.7	7.7	5.3	3.2							
A2	DRN 250/2/80 A1DM(T)	18	15.9	13.5	11.5	9.2	7.2	4.8	2.4						
A3	DRN 300/2/65 A1DT	19.4	17.7	16.2	14.5	12.6	10.5	8.2	5.5	2.1					
A4	DRN 300/2/80 A1DT	20	18.2	15.7	13.7	11.6	9.2	7	4.5	2					
A5	DRN 400/2/65 A1FT	17.2	15.7	14	12.1	10.2	8.3	6.4	4.3	2.4					
A6	DRN 400/2/80 A1FT	18.6	16.8	14.7	12.6	10.8	9	6.9	4.8	3.2	2				
A7	DRN 400/2/100 A1FT	15.8	14.4	12.9	11.2	9.8	8.7	7.6	6.4	5.1	4	3			
A8	DRN 550/2/65 A1FT	21.6	20.4	18.9	17.4	15.9	14.4	12.7	10.9	9.1	7.1	4.8			
A9	DRN 550/2/80 A1FT	23.2	21.2	19.4	17.7	16.2	14.6	12.9	11.2	9.6	8.1	5.8			
A10	DRN 550/2/100 A1FT	20.2	19.5	18	16.4	15.1	13.9	12.6	11.4	10.1	8.9	7.7	6.1	4.1	2.8
B1	DRN 200/4/80 A1DT	9	8.4	7.6	6.9	6.1	5.3	4.4	3.6	2.9					
B2	DRN 200/4/100 A1DT	9	8.4	7.6	6.7	5.9	5.1	4.3	3.4	2.6					
B3	DRN 300/4/80 A1FT	9.5	9.2	8.7	8.2	7.6	7	6.3	5.6	4.9	4.2	3.4			
B4	DRN 300/4/100 A1FT	9.7	9.2	8.7	8.1	7.5	6.8	6.1	5.5	4.8	4.2	3.6			
B5	DRN 400/4/80 A1FT	11.5	11.1	10.5	9.9	9.3	8.8	8.2	7.5	6.8	6.1	5.3	3.9		
B6	DRN 400/4/100 A1FT	11.4	10.9	10.3	9.6	9	8.4	7.8	7.2	6.6	5.8	5	3		
C1	DRN 150/6/80 A1DT	6.1	5.6	5.3	4.9	4.5	4.1	3.6	3.1	2.2					
C2	DRN 150/6/100 A1DT	6	5.6	5.1	4.7	4.2	3.8	3.4	2.9	2.3					
C3	DRN 250/6/100 A1FT	6.4	6.2	5.9	5.6	5.3	5.1	4.8	4.5	4.1	3.7	3.2			
C4	DRN 250/6/150 A1FT	6	5.8	5.5	5.2	4.9	4.7	4.4	4.1	3.9	3.5	3.1	2.4	1.5	1.1

Données techniques - DRN

Datos técnicos - DRN

Corbe	Code	Modèle	Refolement	Passage libre	Puissance (kW)		Pôles	Courant (A)	Câble(*)		Kg		
					P1	P2			Corrente (A)	Cable(*)			
Curva	Código	Modelo	Caudal	Paso libre (mm)	Potencia (kW)		Polos	Run	Start	Std	EX		
A1	0795	DRN 250/2/65 A1DM	DN65	40	2.6	1.8	2	230/1	12.5	55.4	A	B	58
A1	0797	DRN 250/2/65 A1DT	DN 65	40	2.2	1.8	2	400/3	4.3	17.2	A	B	58
A2	0799	DRN 250/2/80 A1DM	DN 80	40	2.6	1.8	2	230/1	12.5	55.4	A	B	56
A2	0800	DRN 250/2/80 A1DT	DN 80	40	2.2	1.8	2	400/3	4.3	17.2	A	B	56
A3	0801	DRN 300/2/65 A1DT	DN 65	40	2.8	2.2	2	400/3	5.1	22.2	A	B	58
A4	0803	DRN 300/2/80 A1DT	DN 80	40	2.8	2.2	2	400/3	5.1	22.2	A	B	58
A5	0805	DRN 400/2/65 A1FT	DN 65	50	4.0	3.0	2	400/3	6.7	29.7	A	C	74
A6	0807	DRN 400/2/80 A1FT	DN 80	50	4.0	3.0	2	400/3	6.7	29.7	A	C	74
A7	0809	DRN 400/2/100 A1FT	DN 100	55	4.0	3.0	2	400/3	6.7	29.7	A	C	82
A8	0811	DRN 550/2/65 A1FT	DN 65	50	5.2	4.1	2	400/3	8.7	38.5	A	C	77
A9	0813	DRN 550/2/80 A1FT	DN 80	50	5.2	4.1	2	400/3	8.7	38.5	A	C	77
A10	0815	DRN 550/2/100 A1FT	DN 100	55	5.2	4.1	2	400/3	8.7	38.5	A	C	85
B1	0817	DRN 200/4/80 A1DT	DN 80	80	2.0	1.5	4	400/3	4.1	18.1	A	B	66
B2	0819	DRN 200/4/100 A1DT	DN 100	80	2.0	1.5	4	400/3	4.1	18.1	A	B	68
B3	0821	DRN 300/4/80 A1FT	DN 80	80	2.9	2.2	4	400/3	5.8	25.7	A	C	86
B4	0825	DRN 300/4/100 A1FT	DN 100	80	2.9	2.2	4	400/3	5.8	25.7	A	C	88
B5	0827	DRN 400/4/80 A1FT	DN 80	80	3.8	3.0	4	400/3	7.3	32.3	A	C	89
B6	0829	DRN 400/4/100 A1FT	DN 100	80	3.8	3.0	4	400/3	7.3	32.3	A	C	91
C1	0831	DRN 150/6/80 A1DT	DN 80	80	1.6	1.1	6	400/3	3.7	15.9	A	B	66
C2	0833	DRN 150/6/100 A1DT	DN 100	80	1.6	1.1	6	400/3	3.7	15.9	A	B	68
C3	0835	DRN 250/6/100 A1FT	DN 100	100	2.8	1.8	6	400/3	5.7	27.5	A	C	100
C4	0837	DRN 250/6/150 A1FT	DN 150	100	2.8	1.8	6	400/3	5.7	27.5	A	C	112

(*): A =07RN-F 4G1,5 + 3x1 B =NSSHOU-J 4G1,5 + 2x0,75 C =NSSHOU-J 4G2,5 + 2x0,75

Modèles DGN

Modelos DGN

Roue vortex à passage libre intégral
 Impulsor Vortex de paso libre integral

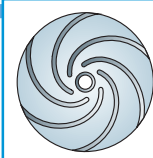

Regroupements de courbes hydrauliques

Conjuntos de curvas hidráulicas

REGROUPEMENT
CONJUNTO

D

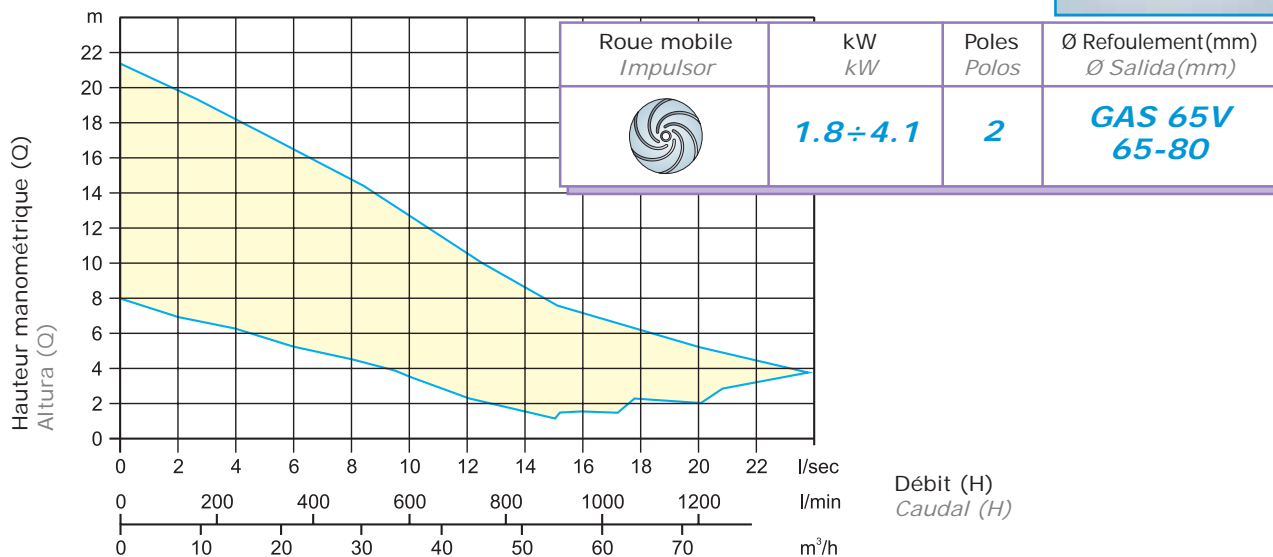

REGROUPEMENT
CONJUNTO

E

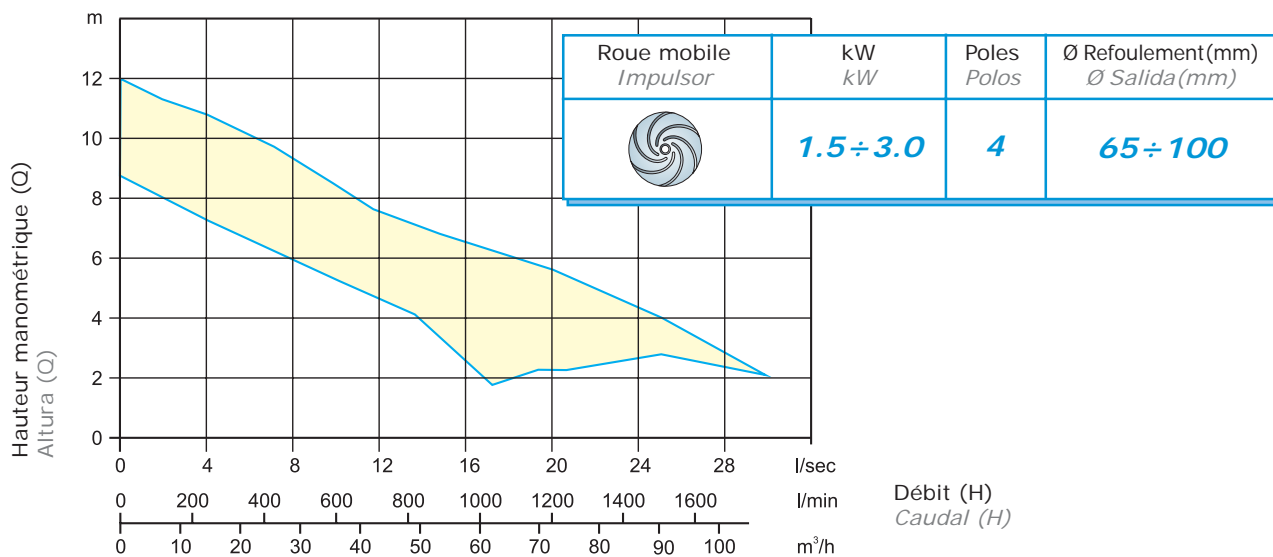

REGROUPEMENT
CONJUNTO

F

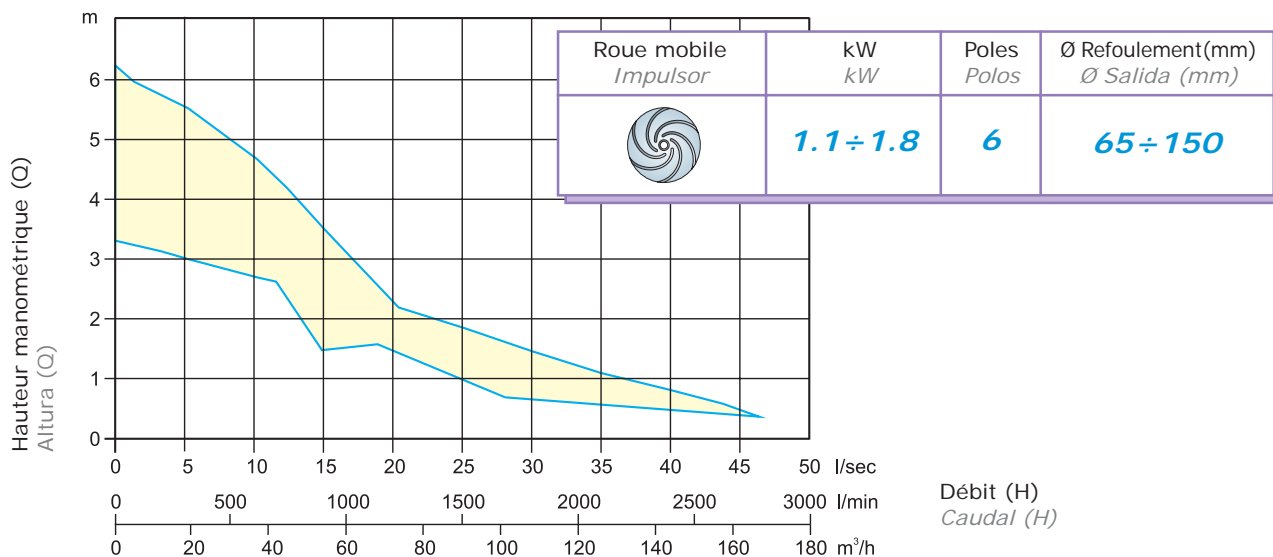

Courbes hydrauliques - DGN

Curvas hidráulicas - DGN

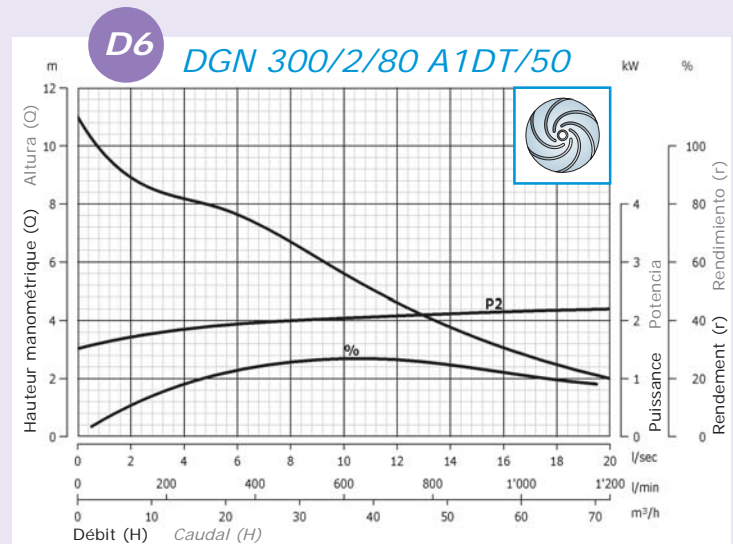
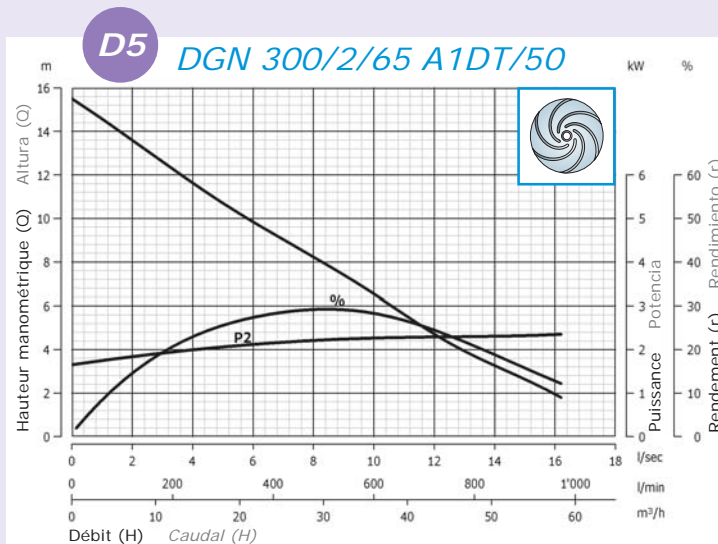
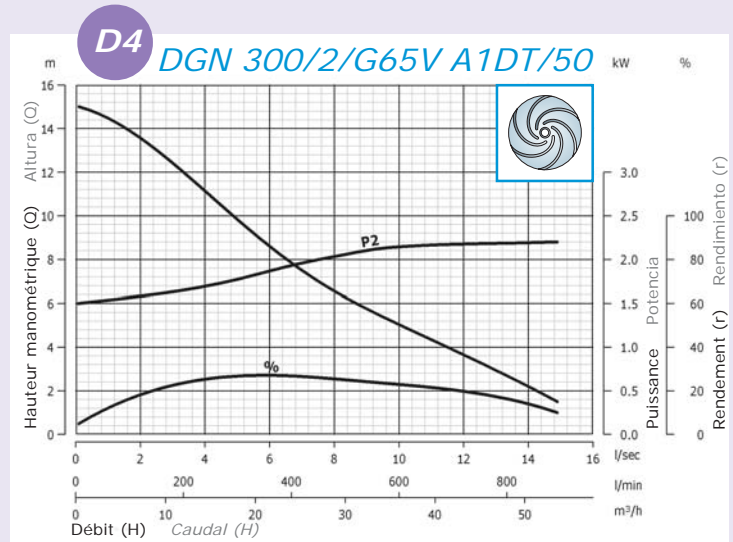
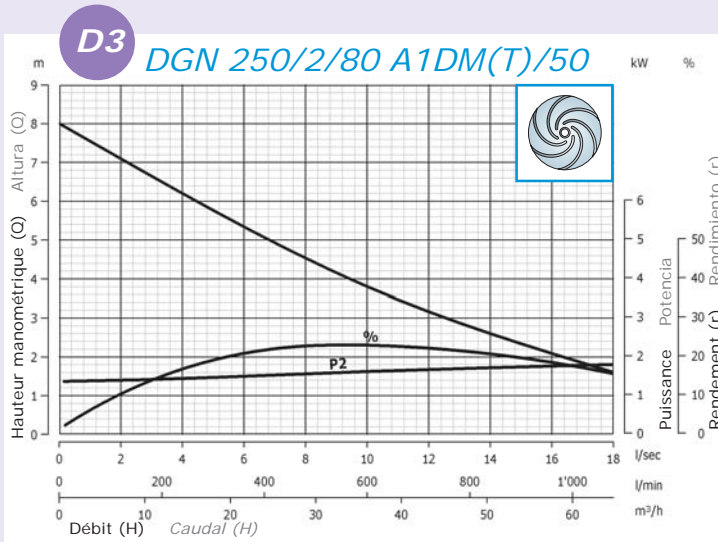
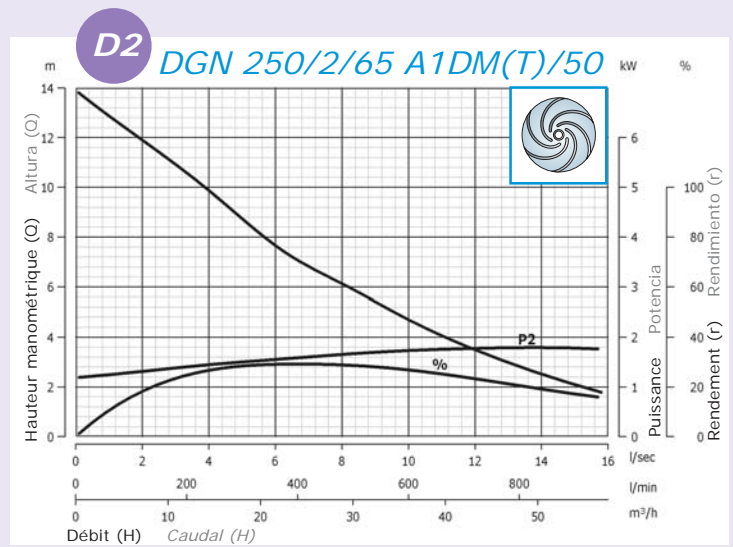
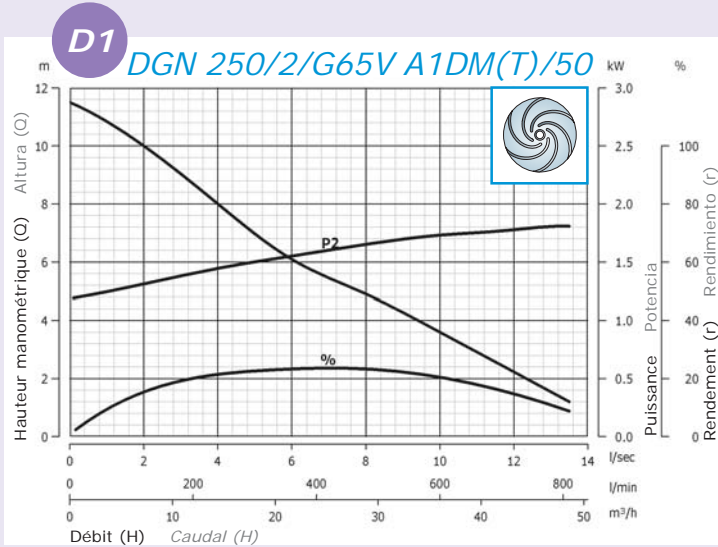

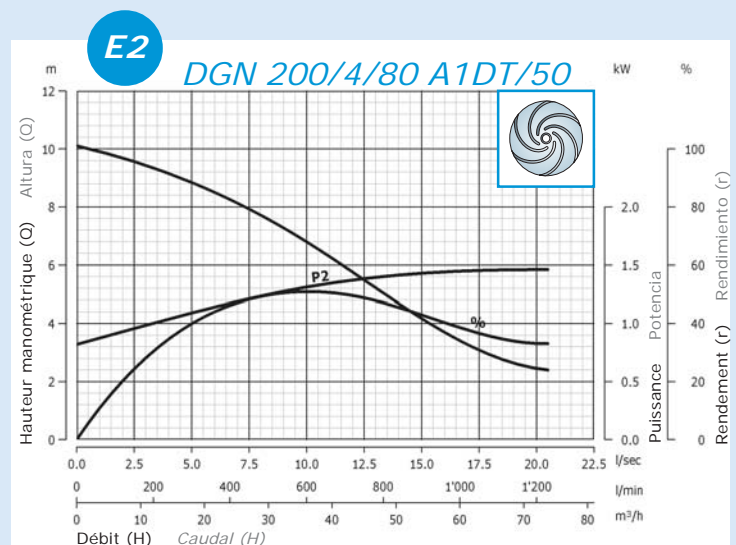
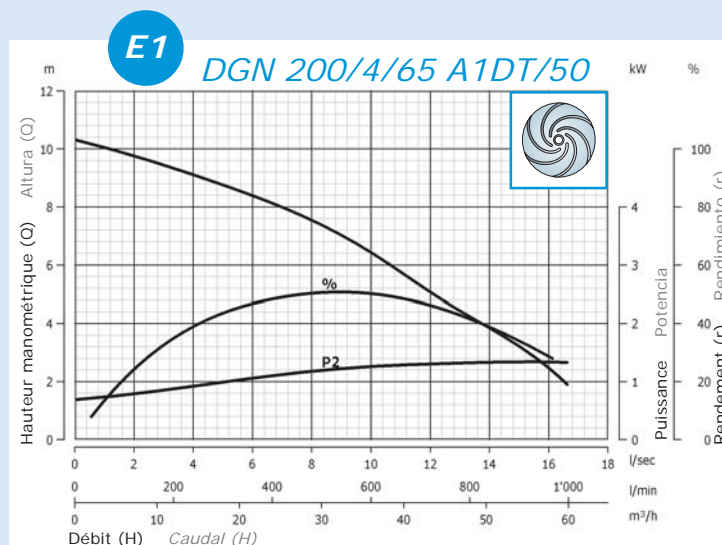
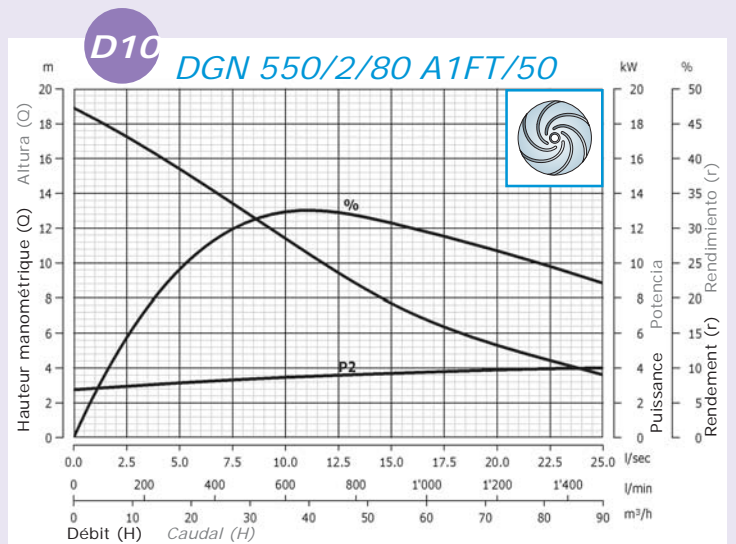
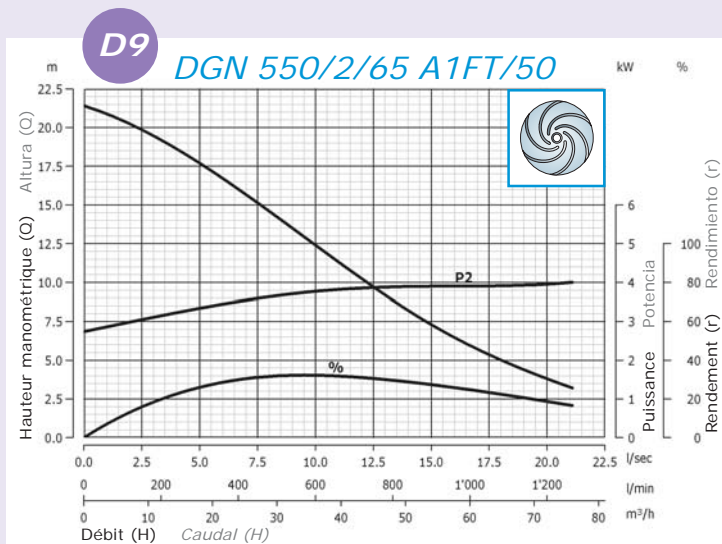
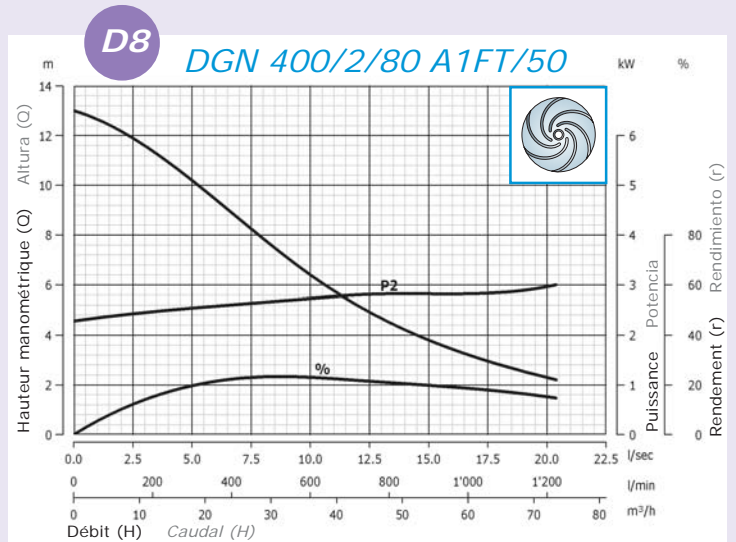
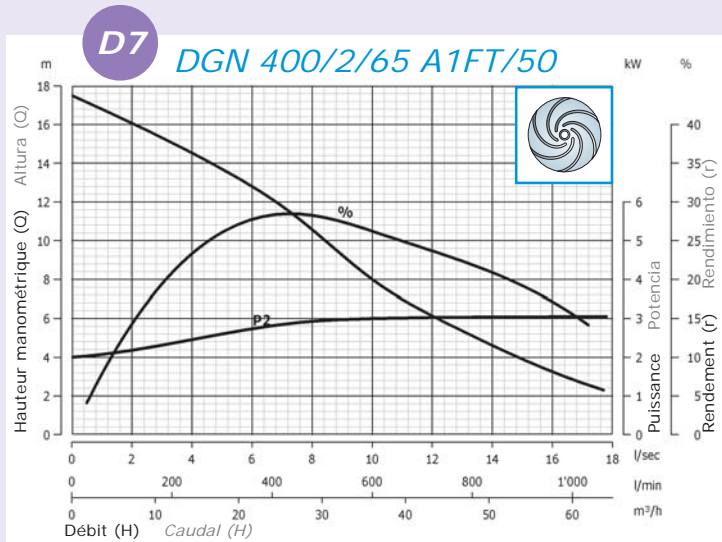

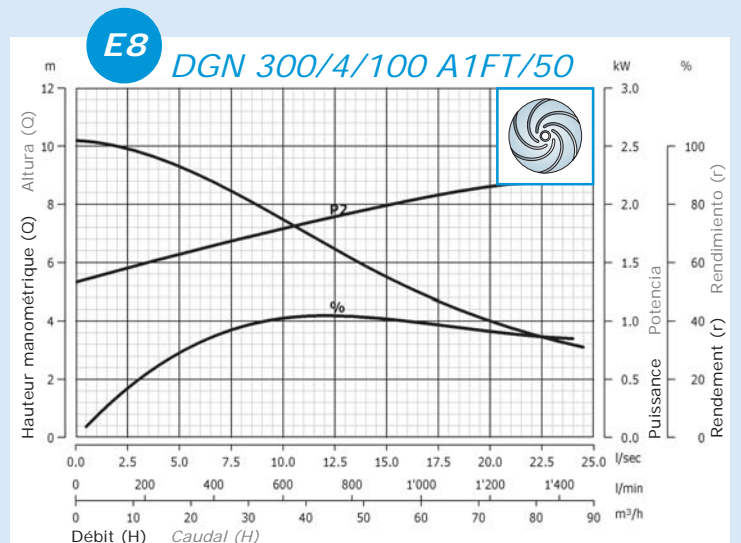
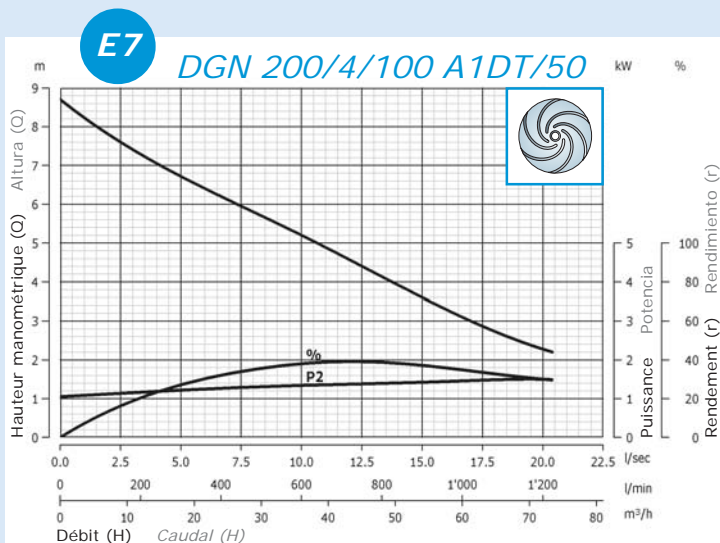
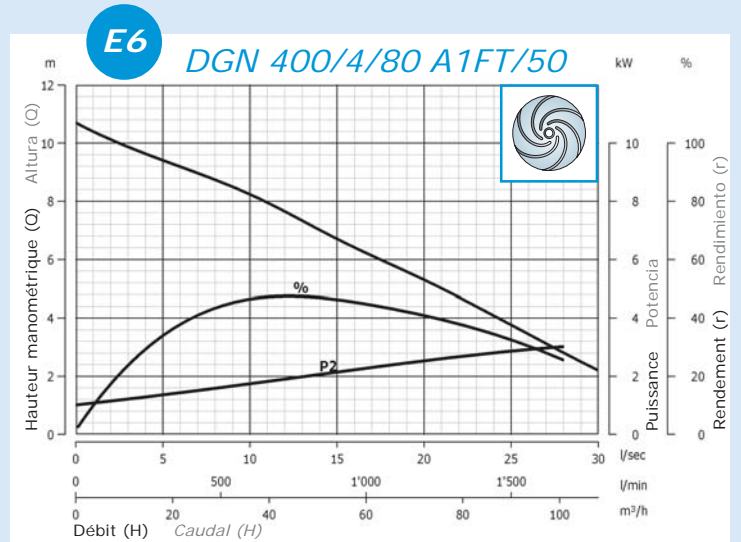
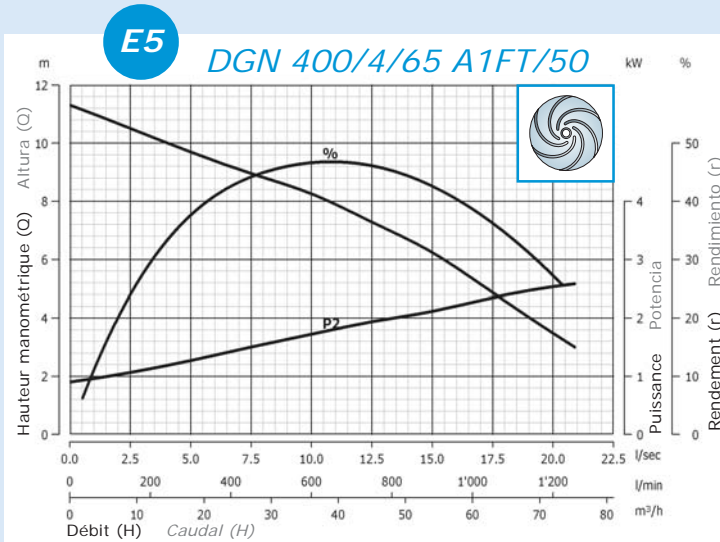
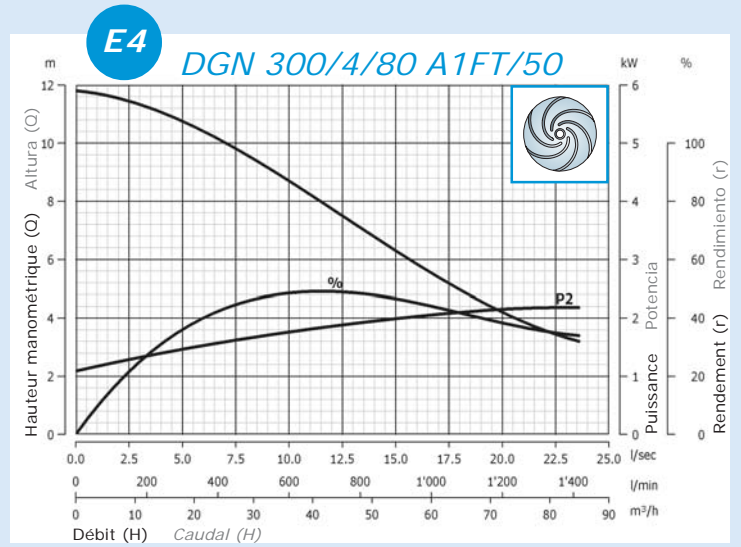
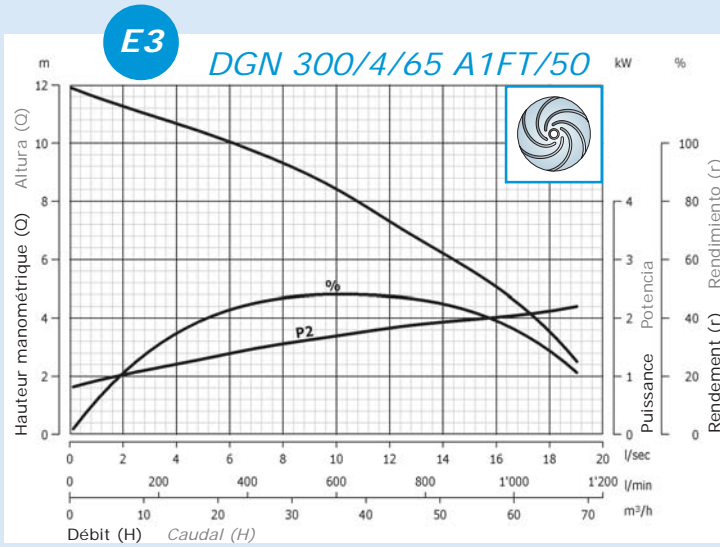

E9

DGN 400/4/100 A1FT/50

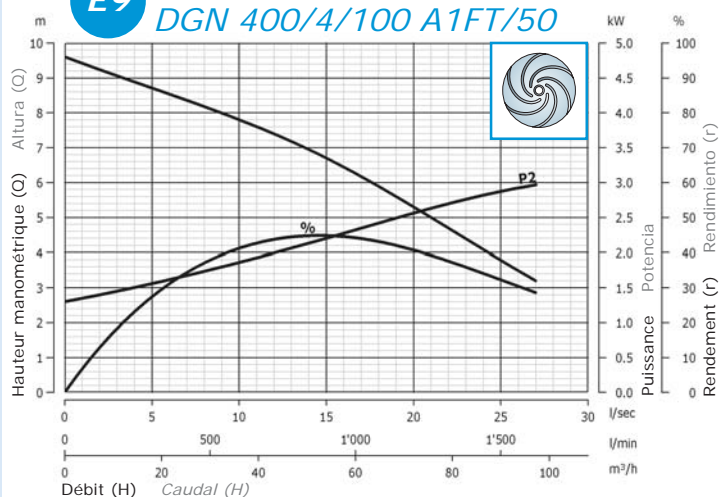

F1

DGN 150/6/65 A1DT/50

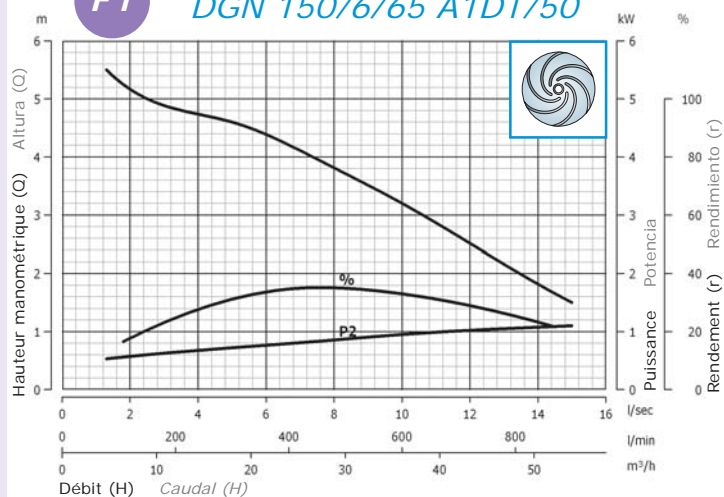

F2

DGN 150/6/80 A1DT/50

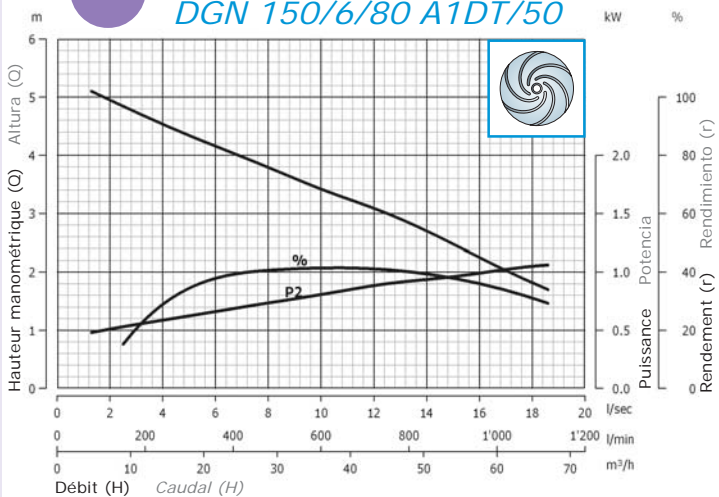

F3

DGN 150/6/100 A1DT/50

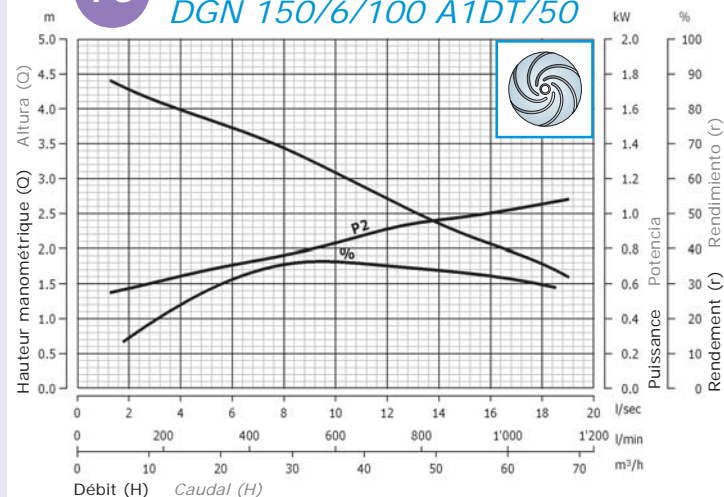

F4

DGN 250/6/100 A1FT/50

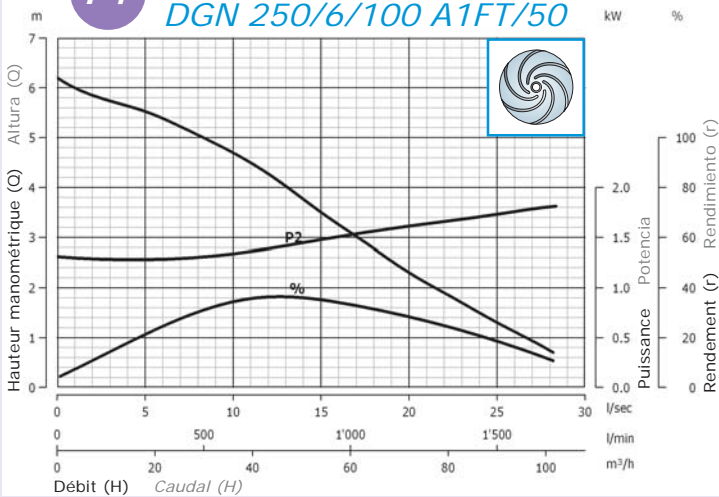

F5

DGN 250/6/150 A1FT/50

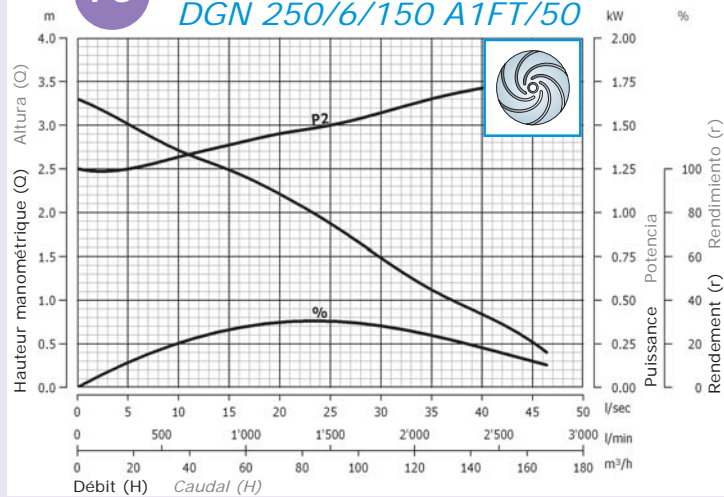

Données hydrauliques - DGN

Datos hidráulicos - DGN

		0	2	4	6	8	10	12	14	16	18	20	22	26	30
		<i>l/s</i>													
		<i>l/min</i>													
		<i>m³/h</i>													
D1	DGN 250/2/G65V A1DM(T)	11.5	10	8	6.1	4.9	3.6	2.2							
D2	DGN 250/2/65 A1DM(T)	13.8	11.9	9.9	7.7	6.1	4.7	3.5	2.5						
D3	DGN 250/2/80 A1DM(T)	8	7.1	6.2	5.3	4.5	3.8	3.2	2.6	2.1	1.6				
D4	DGN 300/2/G65V A1DT	15	13.6	11.1	8.6	6.5	5	3.7	2.2						
D5	DGN 300/2/65 A1DT	15.5	13.6	11.6	9.8	8.2	6.5	4.7	3.3	2					
D6	DGN 300/2/80 A1DT	11	8.9	8.2	7.6	6.7	5.6	4.6	3.8	3.1	2.5	2			
D7	DGN 400/2/65 A1FT	17.5	16.1	14.5	12.8	10.6	8	6.1	4.6	3.2					
D8	DGN 400/2/80 A1FT	13	12.2	10.9	9.4	7.9	6.4	5.2	4.2	3.4	2.8	2.3			
D9	DGN 550/2/65 A1FT	21.4	20.2	18.6	16.7	14.6	12.4	10.2	8.2	6.5	5	3.8			
D10	DGN 550/2/80 A1FT	18.9	17.6	16.2	14.6	13	11.4	9.8	8.4	7.1	6.1	5.3	4.6		
E1	DGN 200/4/65 A1DT	10.4	9.8	9.1	8.4	7.5	6.4	5.1	3.8	2.5					
E2	DGN 200/4/80 A1DT	10.1	9.7	9.2	8.5	7.7	6.8	5.8	4.7	3.7	2.9	2.5			
E3	DGN 300/4/65 A1FT	12	11.3	10.7	10	9.3	8.4	7.3	6.2	5.1	3.5				
E4	DGN 300/4/80 A1FT	11.8	11.5	11.1	10.4	9.6	8.7	7.7	6.8	5.8	5	4.2	3.6		
E5	DGN 400/4/65 A1FT	11.2	10.7	10	9.4	8.8	8.3	7.5	6.7	5.7	4.6	3.5	3.6		
E6	DGN 400/4/80 A1FT	10.7	10.1	9.6	9.2	8.7	8.2	7.6	7	6.4	5.9	5.3	4.7		
E7	DGN 200/4/100 A1DT	8.7	7.8	7.1	6.4	5.8	5.2	4.6	3.9	3.3	2.7	2.3			
E8	DGN 300/4/100 A1FT	10.2	10	9.6	9	8.3	7.5	6.7	5.9	5.2	4.5	4	3.6	3.4	2.2
E9	DGN 400/4/100 A1FT	9.6	9.2	8.9	8.5	8.2	7.8	7.4	6.9	6.4	5.9	5.3	4.7	3.5	
F1	DGN 150/6/65 A1DT	6	5.2	4.7	4.4	3.8	3.2	2.5	1.8						
F2	DGN 150/6/80 A1DT	5.3	4.9	4.5	4.2	3.8	3.4	3.1	2.7	2.3	1.8				
F3	DGN 150/6/100 A1DT	4.6	4.3	4	3.7	3.4	3.1	2.7	2.4	2.1	1.8				
F4	DGN 250/6/100 A1FT	6.2	5.8	5.6	5.4	5	4.7	4.3	3.8	3.3	2.8	2.3	1.9	1.1	
F5	DGN 250/6/150 A1FT	3.3	3.2	3.1	2.9	2.8	2.7	2.6	2.5	2.4	2.3	2.2	2.1	1.8	1.5

Données techniques - DGN

Datos técnicos - DGN

Corbe <i>Curva</i>	Code <i>Código</i>	Modèle <i>Modelo</i>	Refoulement <i>Caudal</i>	Passage libre <i>Paso libre</i> (mm)	Puissance (kW) <i>Potencia (kW)</i>		Pôles <i>Polos</i>	V/~	Courant (A) <i>Corrente (A)</i>		Câble(*) <i>Cable(*)</i>		Kg
					P1	P2			Run	Start	Std	EX	
D1	0571	DGN 250/2/G65V A1DM	GAS 65V	65	2.6	1.8	2	230/1	12.5	55.4	A	B	49
D1	0573	DGN 250/2/G65V A1DT	GAS 65V	65	2.2	1.8	2	400/3	4.3	17.2	A	B	49
D2	0596	DGN 250/2/65 A1DM	DN 65	65	2.6	1.8	2	230/1	12.5	55.4	A	B	51
D2	0575	DGN 250/2/65 A1DT	DN 65	65	2.2	1.8	2	400/3	4.3	17.2	A	B	51
D3	0594	DGN 250/2/80 A1DM	DN 80	80	2.6	1.8	2	230/1	12.5	55.4	A	B	53
D3	0577	DGN 250/2/80 A1DT	DN 80	80	2.2	1.8	2	400/3	4.3	17.2	A	B	53
D4	0579	DGN 300/2/G65V A1DT	GAS 65V	65	2.8	2.2	2	400/3	5.1	22.2	A	B	51
D5	0507	DGN 300/2/65 A1DT	DN 65	65	2.8	2.2	2	400/3	5.1	22.2	A	B	53
D6	0509	DGN 300/2/80 A1DT	DN 80	80	2.8	2.2	2	400/3	5.1	22.2	A	B	55
D7	0511	DGN 400/2/65 A1FT	DN 65	65	4.0	3.0	2	400/3	6.7	29.7	A	C	74
D8	0513	DGN 400/2/80 A1FT	DN 80	80	4.0	3.0	2	400/3	6.7	29.7	A	C	75
D9	0515	DGN 550/2/65 A1FT	DN 65	65	5.2	4.1	2	400/3	8.7	38.5	A	C	78
D10	0517	DGN 550/2/80 A1FT	DN 80	80	5.2	4.1	2	400/3	8.7	38.5	A	C	79
E1	0581	DGN 200/4/65 A1DT	DN 65	65	2.0	1.5	4	400/3	4.1	18.1	A	B	63
E2	0519	DGN 200/4/80 A1DT	DN 80	80	2.0	1.5	4	400/3	4.1	18.1	A	B	64
E3	0583	DGN 300/4/65 A1FT	DN 65	65	2.9	2.2	4	400/3	5.8	25.7	A	C	78
E4	0523	DGN 300/4/80 A1FT	DN 80	80	2.9	2.2	4	400/3	5.8	25.7	A	C	79
E5	0585	DGN 400/4/65 A1FT	DN 65	65	3.8	3.0	4	400/3	7.3	32.3	A	C	82
E6	0527	DGN 400/4/80 A1FT	DN 80	80	3.8	3.0	4	400/3	7.3	32.3	A	C	83
E7	0521	DGN 200/4/100 A1DT	DN 100	100	2.0	1.5	4	400/3	4.1	18.1	A	B	66
E8	0525	DGN 300/4/100 A1FT	DN 100	100	2.9	2.2	4	400/3	5.8	25.7	A	C	81
E9	0529	DGN 400/4/100 A1FT	DN 100	100	3.8	3.0	4	400/3	7.3	32.3	A	C	85
F1	0841	DGN 150/6/65 A1DT	DN 65	65	1.6	1.1	6	400/3	3.7	15.9	A	B	61
F2	0843	DGN 150/6/80 A1DT	DN 80	80	1.6	1.1	6	400/3	3.7	15.9	A	B	62
F3	0845	DGN 150/6/100 A1DT	DN 100	100	1.6	1.1	6	400/3	3.7	15.9	A	B	66
F4	0856	DGN 250/6/100 A1FT	DN 100	100	2.8	1.8	6	400/3	5.7	27.5	A	C	111
F5	0858	DGN 250/6/150 A1FT	DN 150	150	2.8	1.8	6	400/3	5.7	27.5	A	C	114

(*): **A** =07RN-F 4G1,5 + 3x1 **B** =NSSHOU-J 4G1,5 + 2x0,75 **C** =NSSHOU-J 4G2,5 + 2x0,75

Modèles GRN

Modelos GRN

Roue multicanal ouverte avec système de broyage
 Impulsor de canales múltiples abierto con sistema de trituración

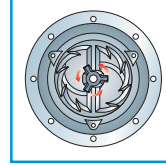
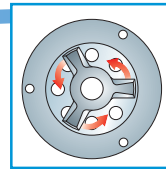

Regroupements de courbes hydrauliques

Conjuntos de curvas hidráulicas

REGROUPEMENT
CONJUNTO

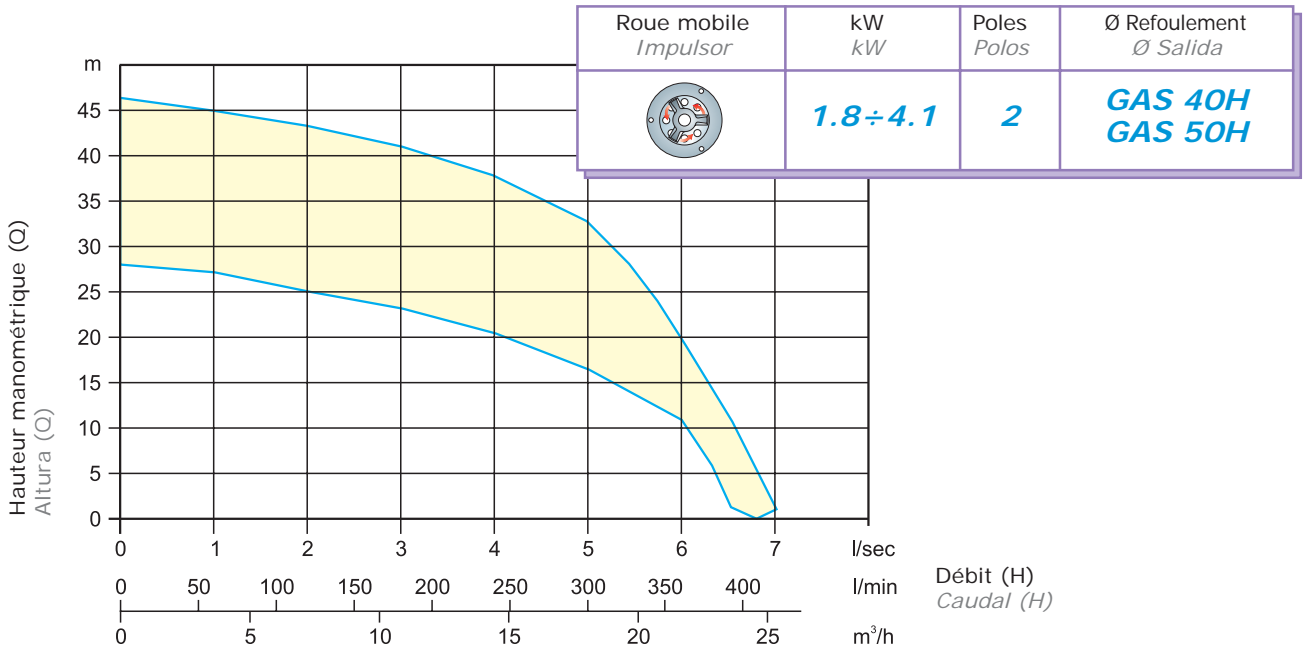

REGROUPEMENT
CONJUNTO

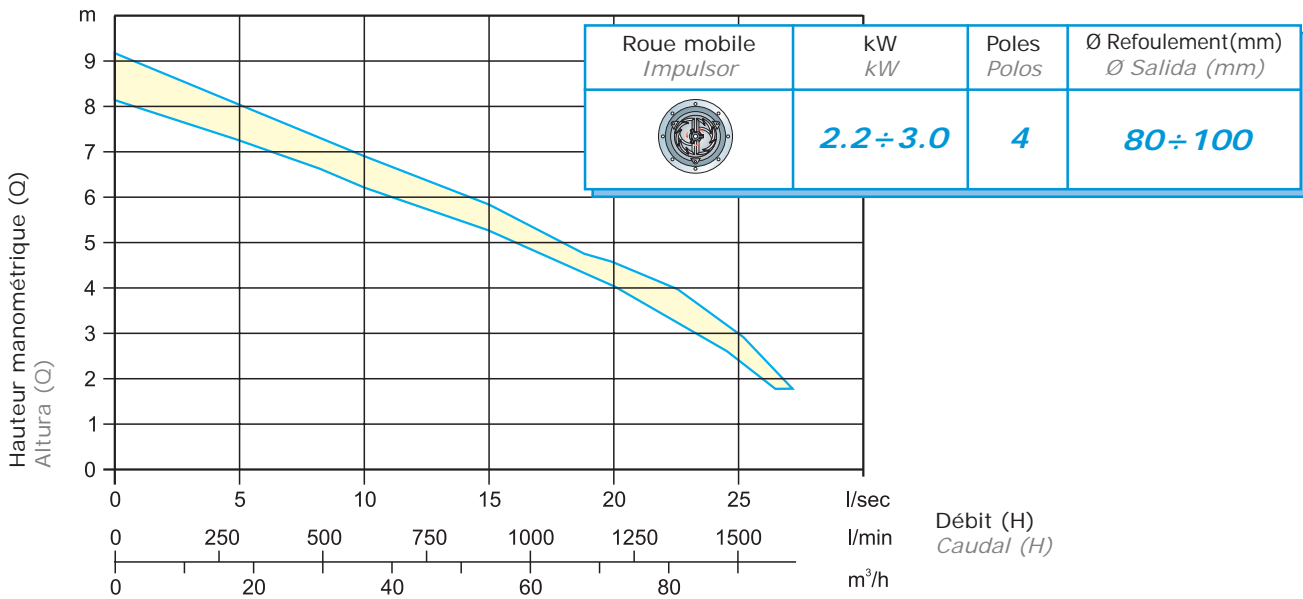

Courbes hydrauliques - GRN

Curvas hidráulicas - GRN

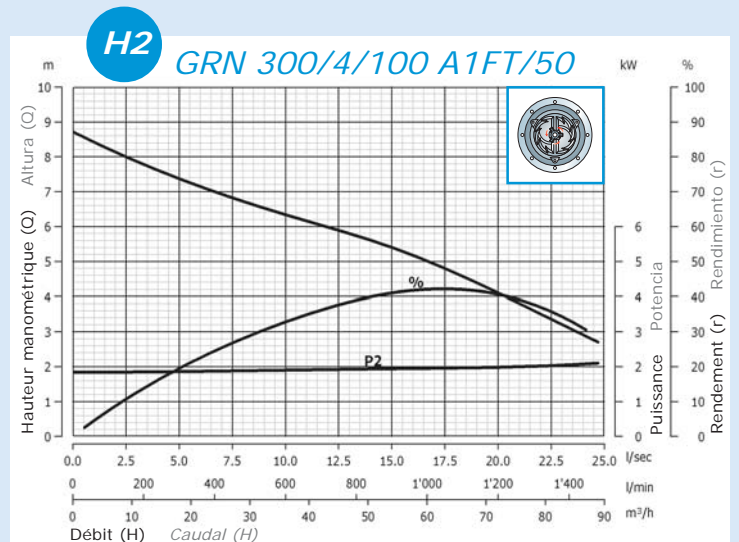
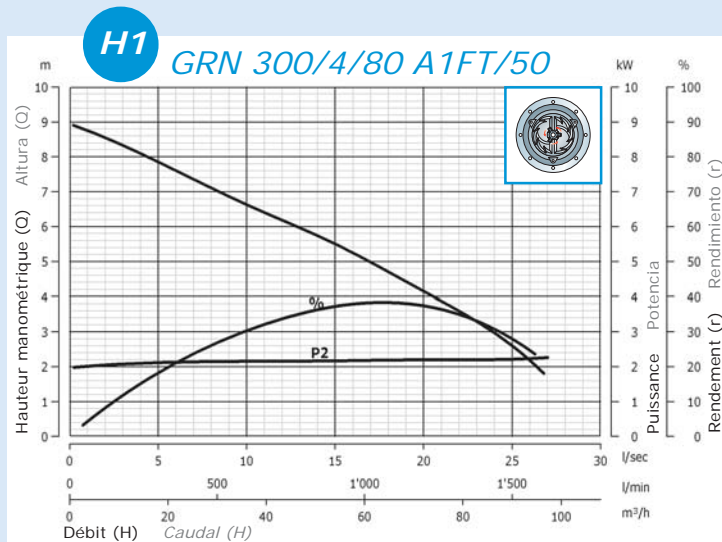
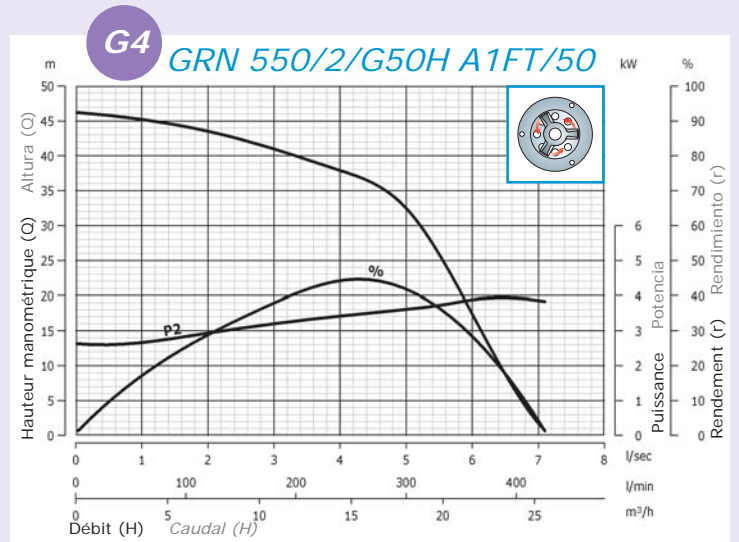
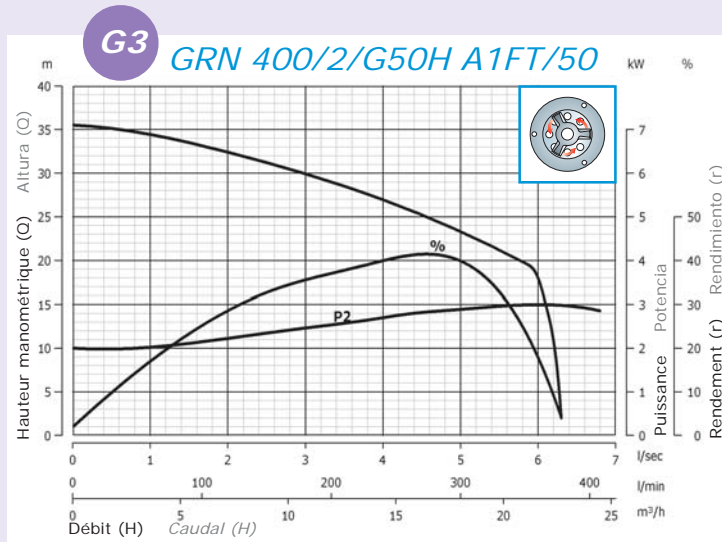
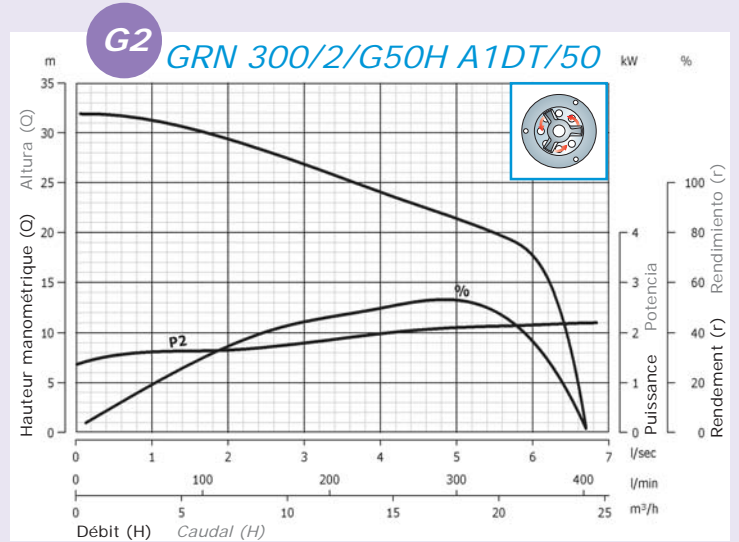
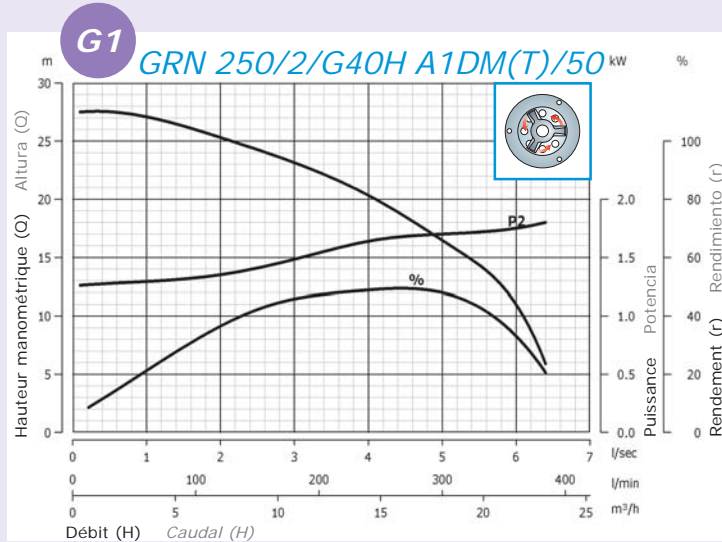

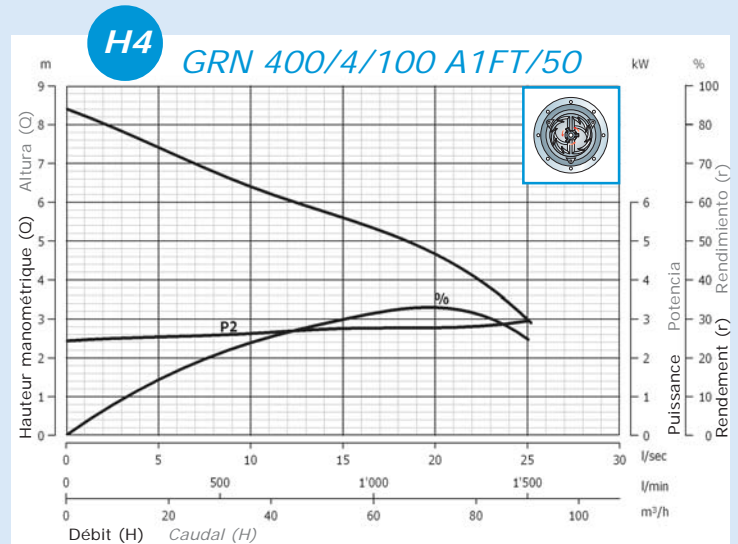
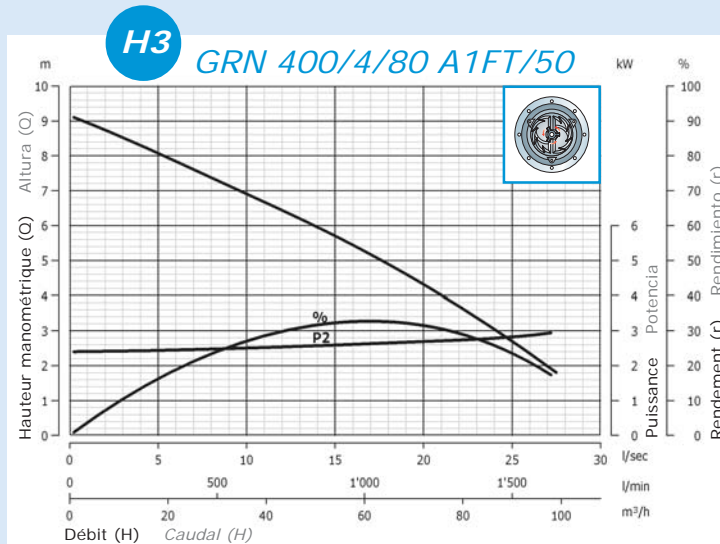

Données hydrauliques - GRN

Datos hidráulicos - GRN

	0	2	4	6	8	10	12	14	16	18	20	22	24	26
<i>l/s</i>	0	2	4	6	8	10	12	14	16	18	20	22	24	26
<i>l/min</i>	0	120	240	360	480	600	720	840	960	1080	1200	1320	1440	1560
<i>m³/h</i>	0	7.2	14.4	21.6	28.8	36	43.2	50.4	57.6	64.8	72	79.2	86.4	93.6

G1	GRN 250/2/G40H A1DM(T)	27.5	25.3	20.3	11										
G2	GRN 300/2/G50H A1DT	32	29.4	24	17.7										
G3	GRN 400/2/G50H A1FT	35.5	32.4	27	18										
G4	GRN 550/2/G50H A1FT	46.2	43.5	37.9	17.4										
H1	GRN 300/4/80 A1FT	9	8.5	8.1	7.6	7.1	6.6	6.2	5.7	5.2	4.7	4.1	3.6	3	
H2	GRN 300/4/100 A1FT	8.7	8.1	7.6	7.1	6.7	6.3	6	5.6	5.2	4.7	4.1	3.5	2.9	2.2
H3	GRN 400/4/80 A1FT	9.1	8.7	8.3	7.8	7.4	6.9	6.4	6	5.4	4.9	4.3	3.7	3	
H4	GRN 400/4/100 A1FT	8.4	8	7.6	7.2	6.8	6.4	6.1	5.8	5.4	5.1	4.7	4.1	3.4	2.3

Tableau données techniques - GRN

Tabla de datos técnicos - GRN

Corbe <i>Curva</i>	Code <i>Código</i>	Modèle <i>Modelo</i>	Refolement <i>Caudal</i>	Puissance (kW) <i>Potencia (kW)</i>		Pôles <i>Polos</i>	V/~	Courant (A) <i>Corrente (A)</i>		Câble(*) <i>Cable(*)</i>		Kg
				P1	P2			Run	Start	Std	EX	
G1	0749	GRN 250/2/G40H A1DM/50	GAS 1 1/2"	2.6	1.8	2	230/1	12.5	55.4	A	B	44
G1	0750	GRN 250/2/G40H A1DT/50	GAS 1 1/2"	2.2	1.8	2	400/3	4.3	17.2	A	B	44
G2	0535	GRN 300/2/G50H A1DT/50	GAS 2"	2.8	2.2	2	400/3	5.1	22.6	A	B	47
G3	0537	GRN 400/2/G50H A1FT/50	GAS 2"	4.0	3.0	2	400/3	6.7	29.7	A	C	69
G4	0539	GRN 550/2/G50H A1FT/50	GAS 2"	5.2	4.1	2	400/3	8.7	38.5	A	C	72
H1	0541	GRN 300/4/80 A1FT/50	DN 80	2.9	2.2	4	400/3	5.8	25.7	A	C	87
H2	0542	GRN 300/4/100 A1FT/50	DN 100	2.9	2.2	4	400/3	5.8	25.7	A	C	89
H3	0543	GRN 400/4/80 A1FT/50	DN 80	3.8	3.0	4	400/3	7.3	32.3	A	C	90
H4	0544	GRN 400/4/100 A1FT/50	DN 100	3.8	3.0	4	400/3	7.3	32.3	A	C	92

(*): **A** =07RN-F 4G1,5 + 3x1 **B** =NSSHOU-J 4G1,5 + 2x0,75 **C** =NSSHOU-J 4G2,5 + 2x0,75

Modèles APN

Modelos APN

Roue multicanal ouverte grande hauteur
 Impulsor de canales múltiples abierto de altura de impulsión elevada

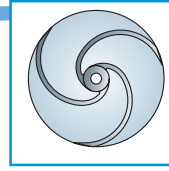

Regroupements de courbes hydrauliques

Conjuntos de curvas hidráulicas

REGROUPEMENT
CONJUNTO

1

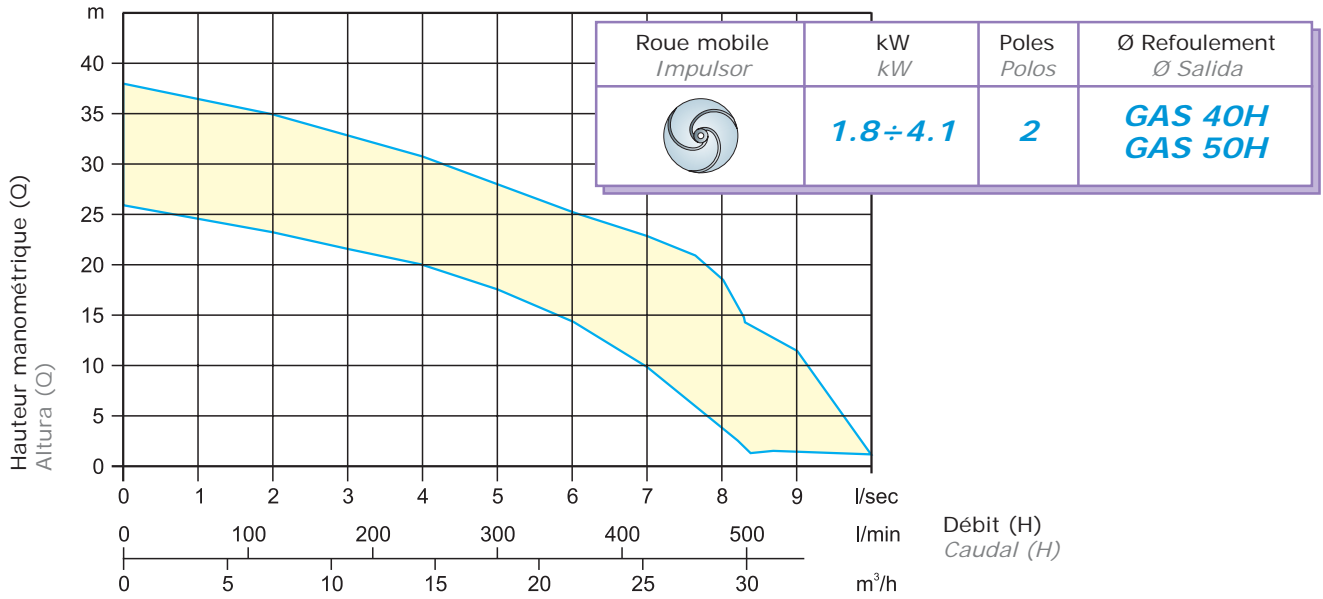

Courbes hydrauliques - APN

Curvas hidráulicas - APN

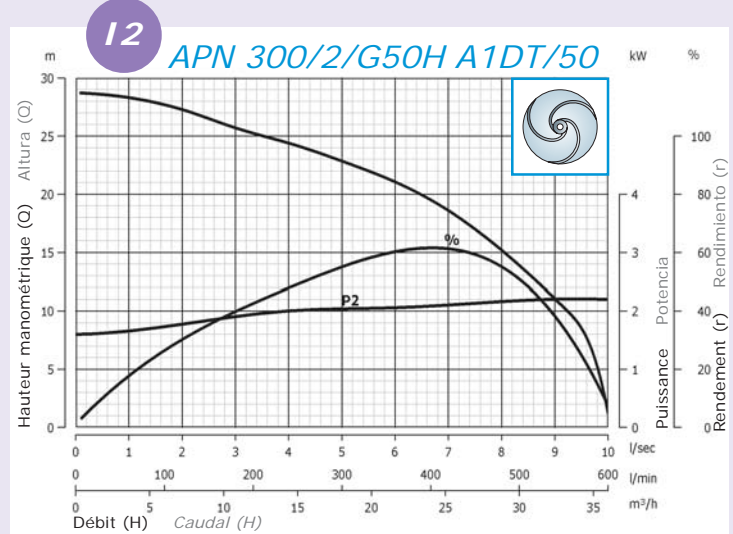
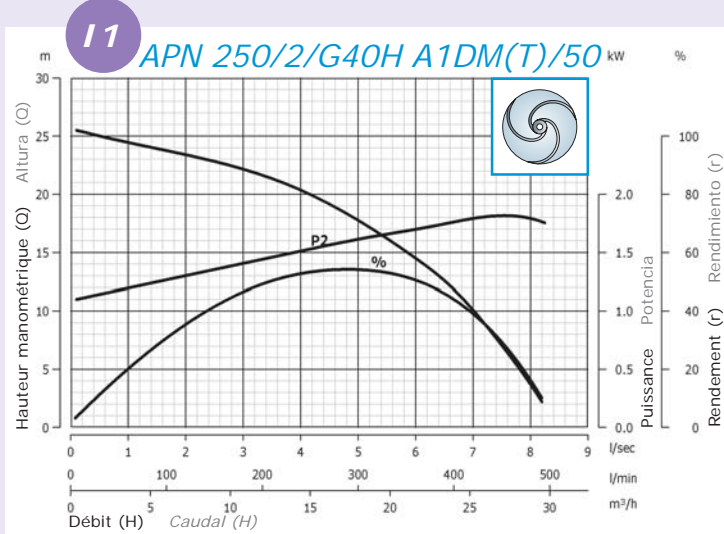

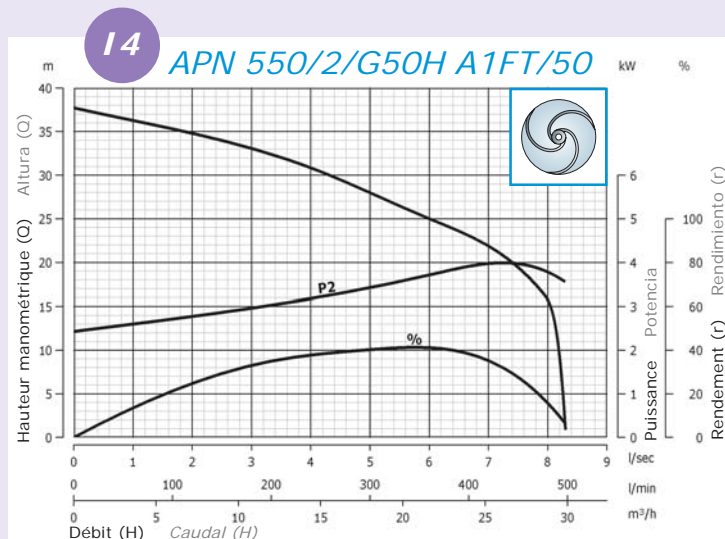
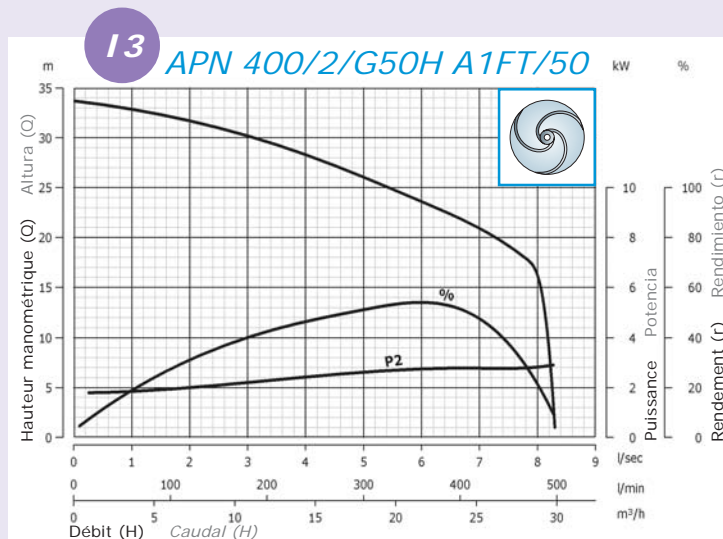

Données hydrauliques - APN

Datos hidráulicos - APN

		0	1	2	3	4	5	6	7	8	9	10
	I/s	0	1	2	3	4	5	6	7	8	9	10
	I/min	0	60	120	180	240	300	360	420	480	540	600
	m³/h	0	3.6	7.2	10.8	14.4	18	21.6	25.2	28.8	32.4	36
I1	APN 250/2/G40H A1DM(T)	25.1	23.4	24.4	22.2	20.4	17.8	14.5	10.1	3.7		
I2	APN 300/2/G50H A1DT	25.7	27.3	28.3	25.7	24.4	22.9	21.1	18.6	15.2	11.1	1.2
I3	APN 400/2/G50H A1FT	33.7	31.7	32.9	30.2	28.3	26	23.6	20.9	16.2		
I4	APN 550/2/G50H A1FT	37.7	34.8	36.3	33.1	30.8	28	25	21.9	15.8		

Tableau données techniques - APN

Tabla de datos técnicos - APN

Corbe Curva	Code Código	Modèle Modelo	Refoulement Caudal	Puissance (kW) Potencia (kW)		Pôles Polos	V/~	Courant (A) Corrente (A)		Câble(*) Cable(*)		Kg
				P1	P2			Run	Start	Std	EX	
I1	0753	APN 250/2/G40H A1DM/50	GAS 40H	2.6	1.8	2	230/1	12.5	55.4	A	B	43
I1	0754	APN 250/2/G40H A1DT/50	GAS 40H	2.2	1.8	2	400/3	4.3	17.2	A	B	43
I2	0549	APN 300/2/G50H A1DT/50	GAS 50H	2.8	2.2	2	400/3	5.1	22.6	A	B	46
I3	0551	APN 400/2/G50H A1FT/50	GAS 50H	4.0	3.0	2	400/3	6.7	29.7	A	C	68
I4	0553	APN 550/2/G50H A1FT/50	GAS 50H	5.2	4.1	2	400/3	8.7	38.5	A	C	71

(*): **A** =07RN-F 4G1,5 + 3x1 **B** =NSSHOU-J 4G1,5 + 2x0,75 **C** =NSSHOU-J 4G2,5 + 2x0,75

Modèles MAN

Modelos MAN

Roue monocanal ouverte
Impulsor de un canal abierto

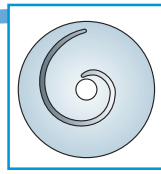

Regroupements de courbes hydrauliques

Conjuntos de curvas hidráulicas

REGROUPEMENT
CONJUNTO

J

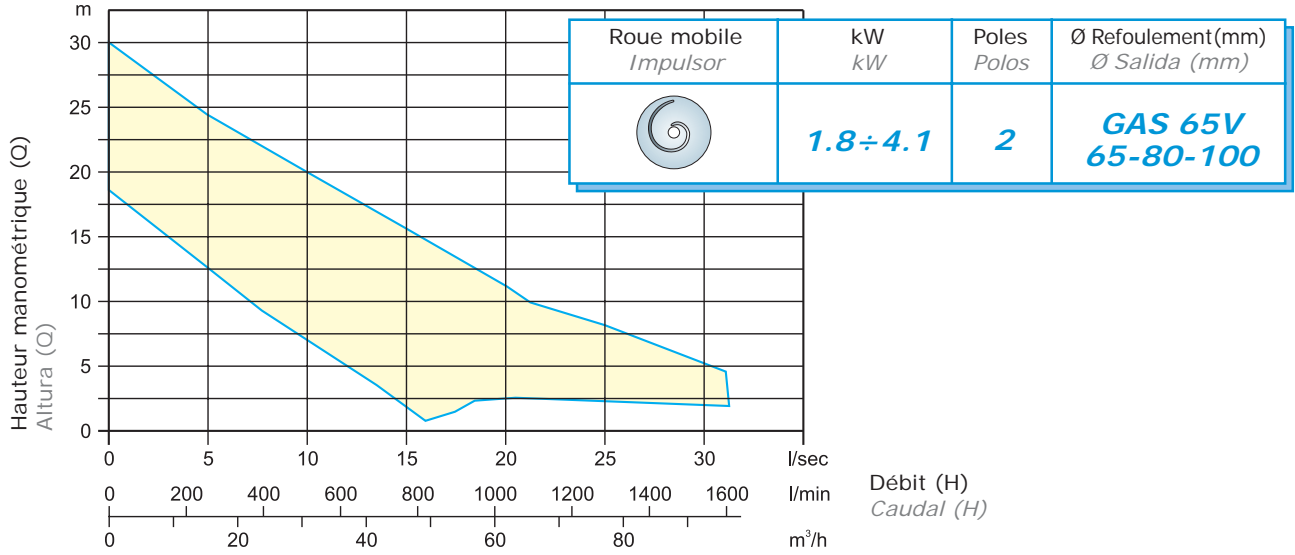

REGROUPEMENT
CONJUNTO

K

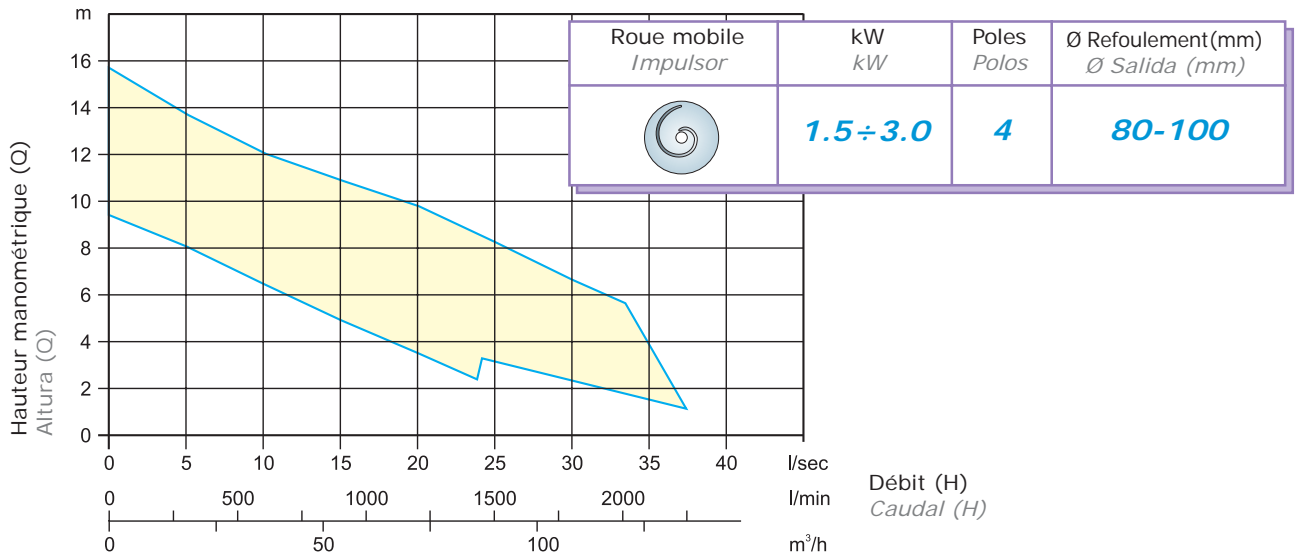

REGROUPEMENT
CONJUNTO

L

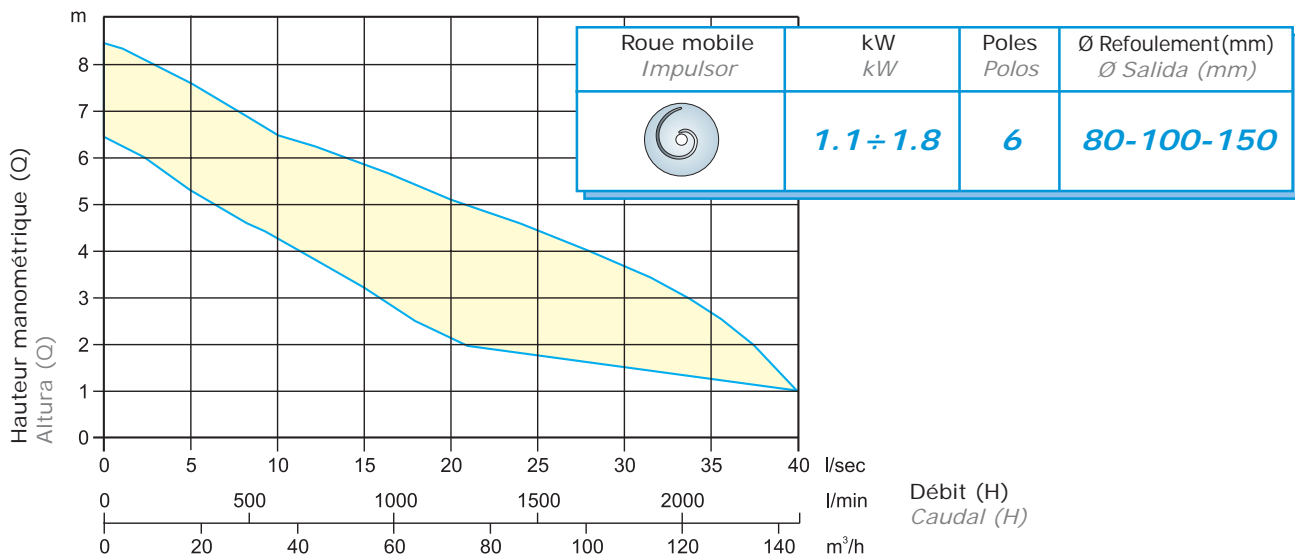

Courbes hydrauliques - APN

Curvas hidráulicas - APN

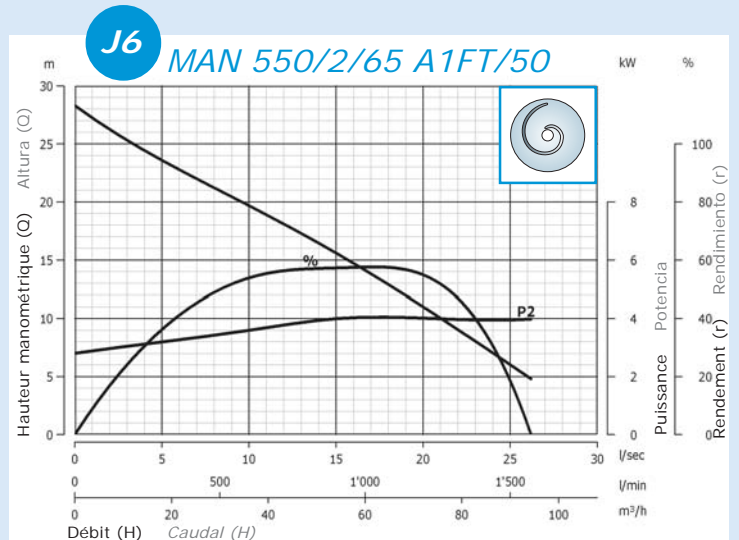
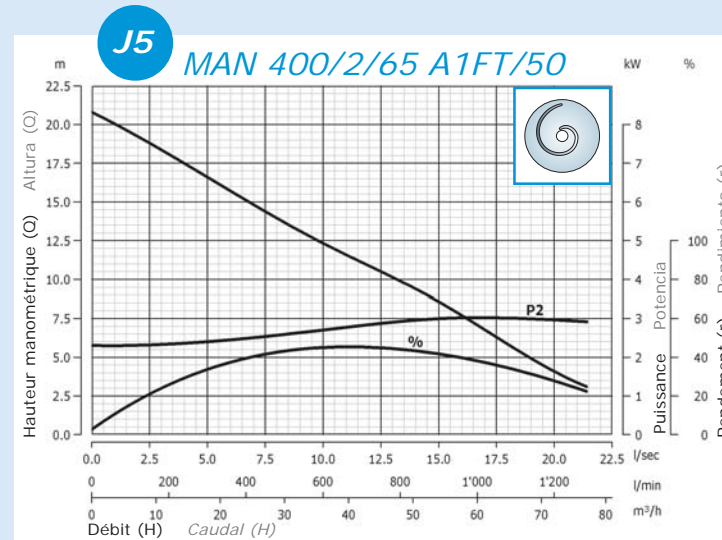
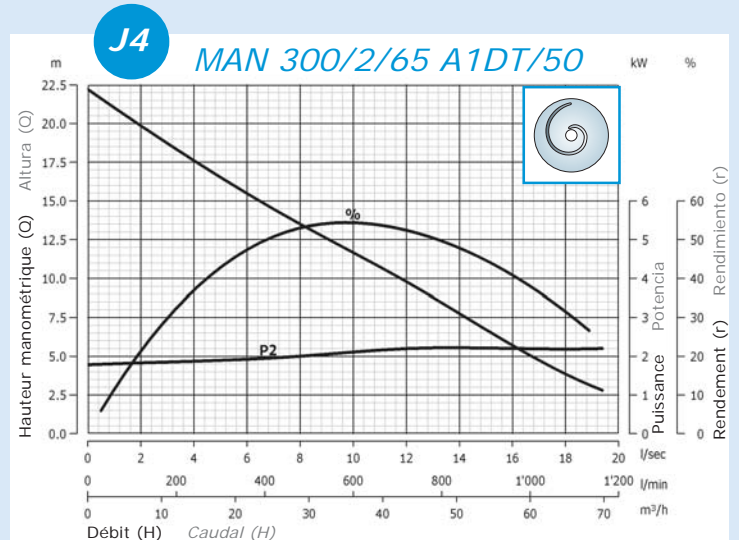
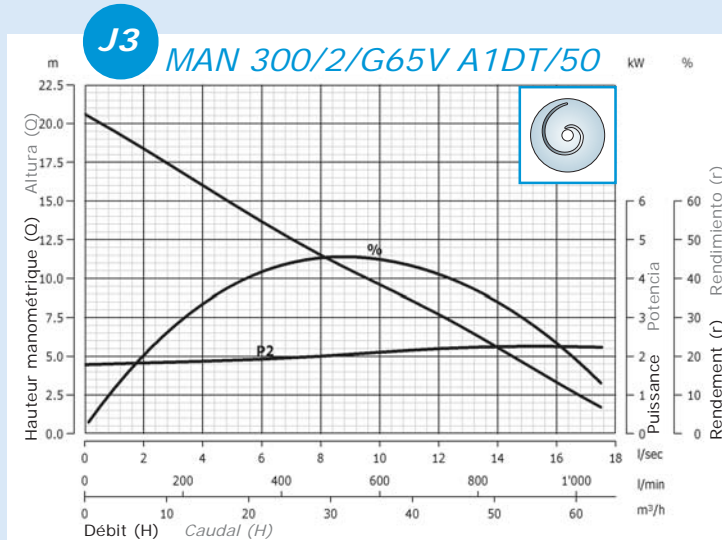
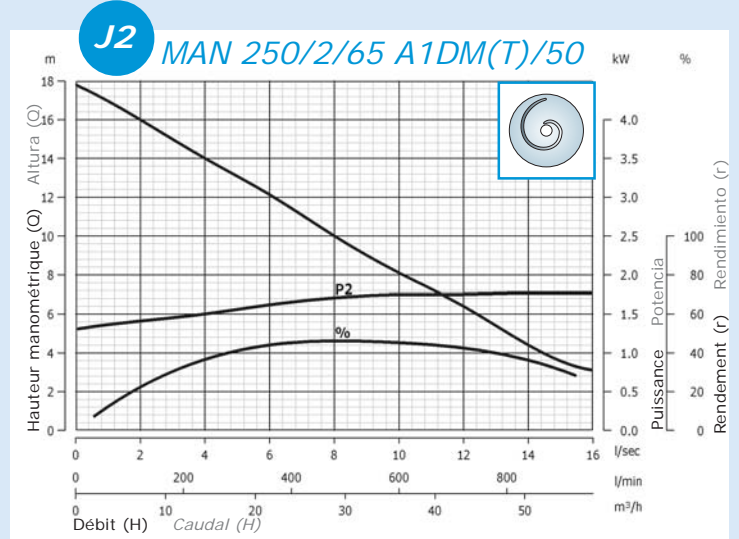
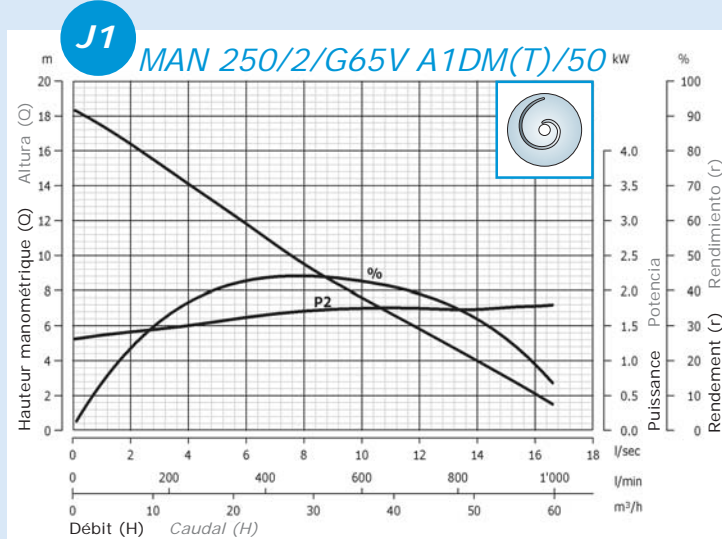

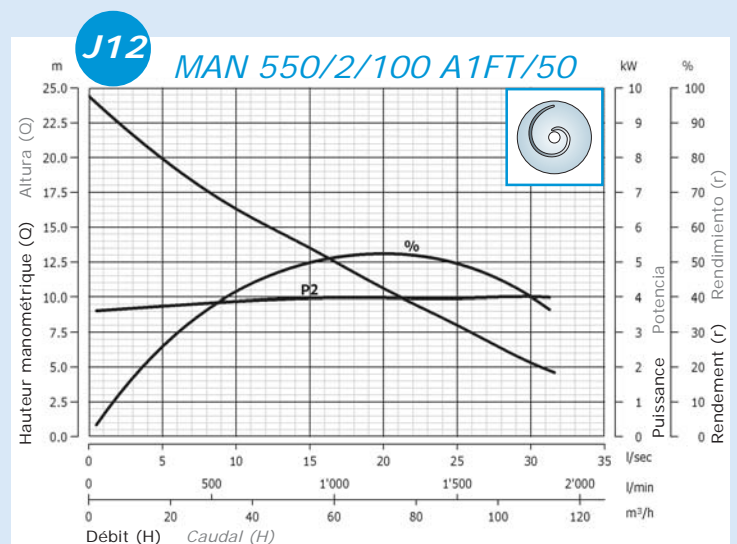
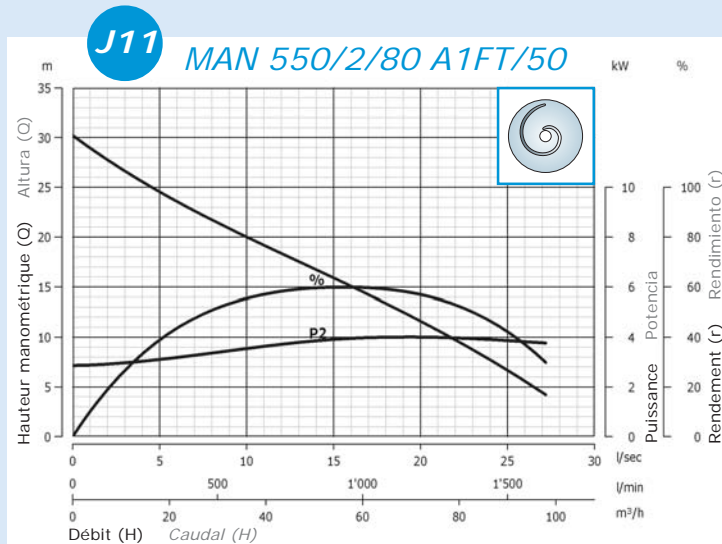
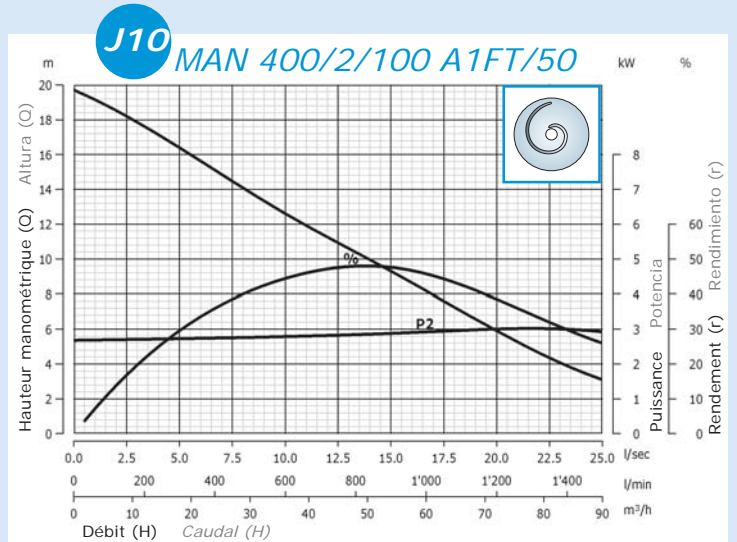
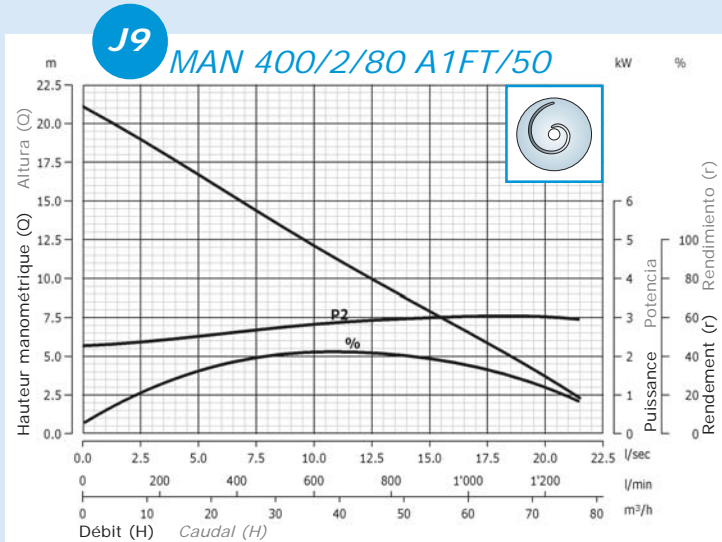
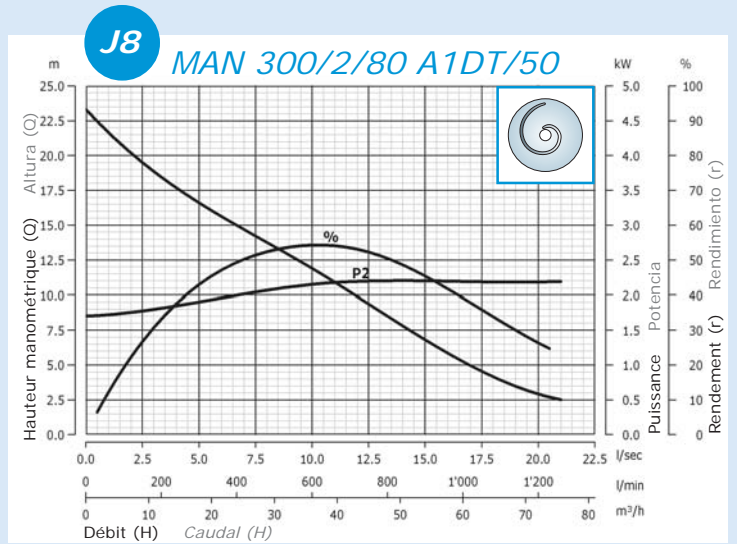
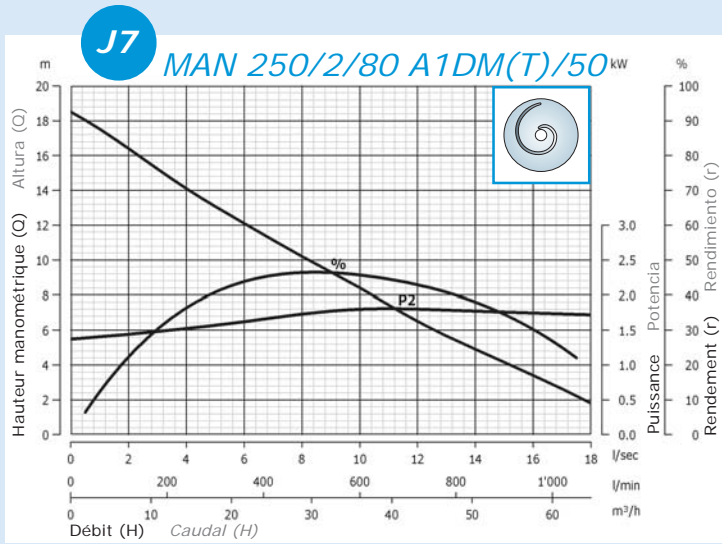

K1

MAN 200/4/80 A1DT/50

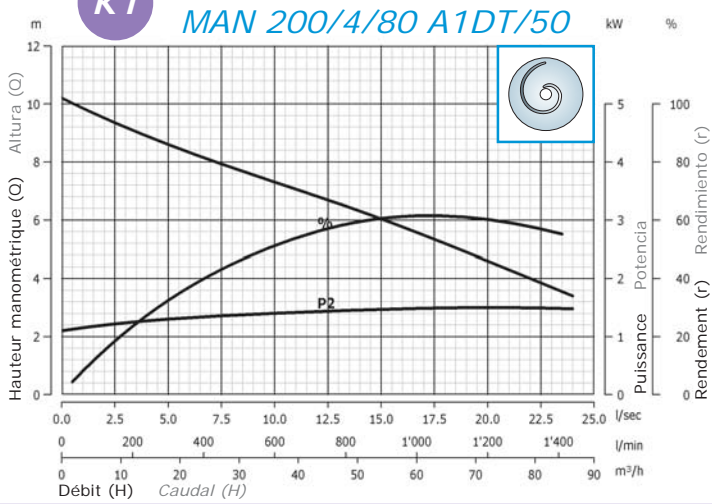

K2

MAN 200/4/100 A1DT/50

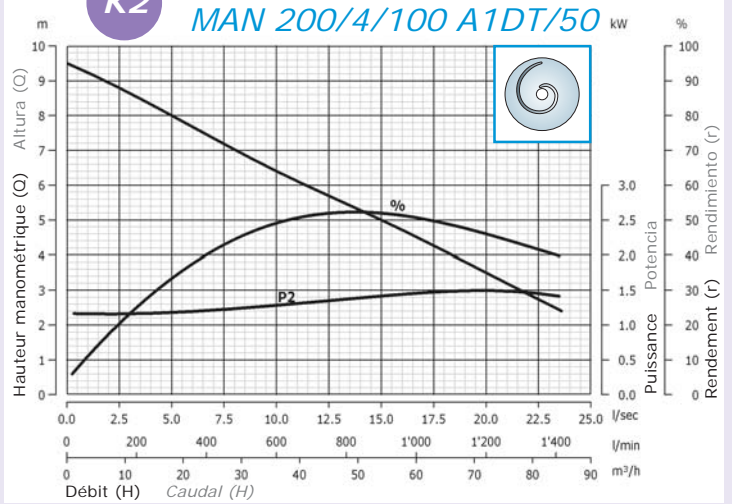

K3

MAN 300/4/80 A1FT/50

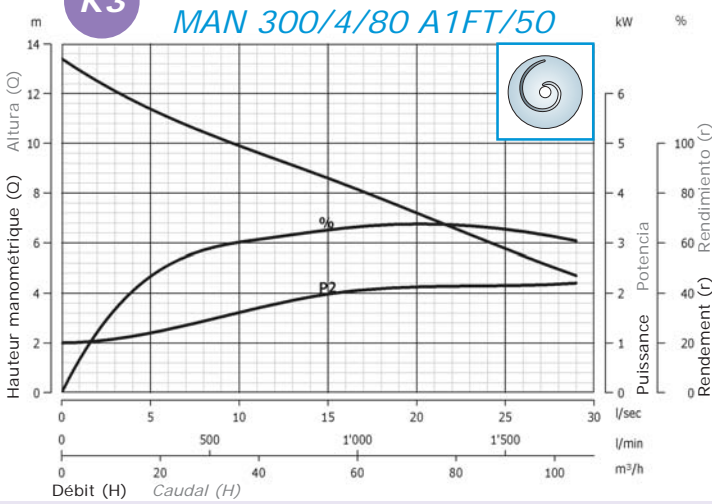

K4

MAN 300/4/100 A1FT/50

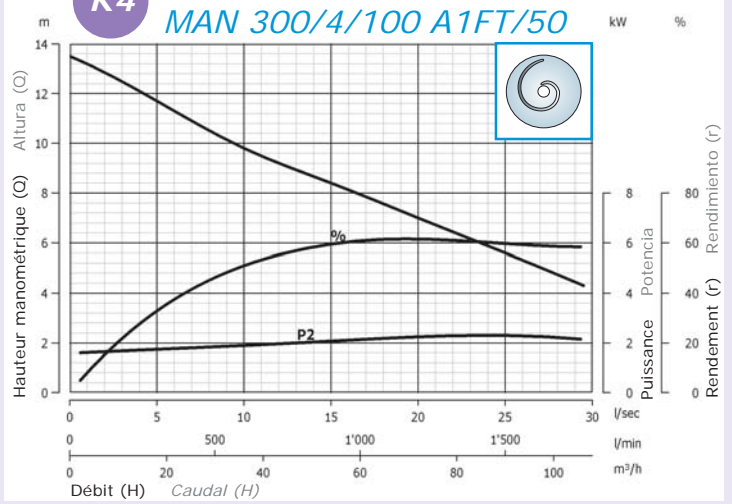

K5

MAN 400/4/80 A1FT/50

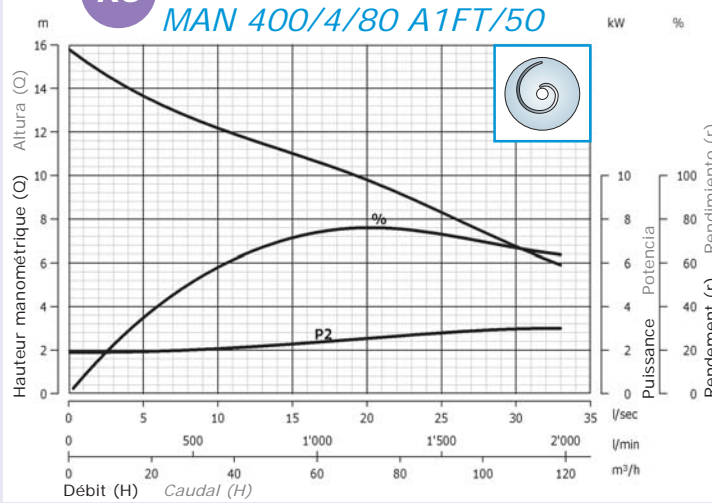

K6

MAN 400/4/100 A1FT/50

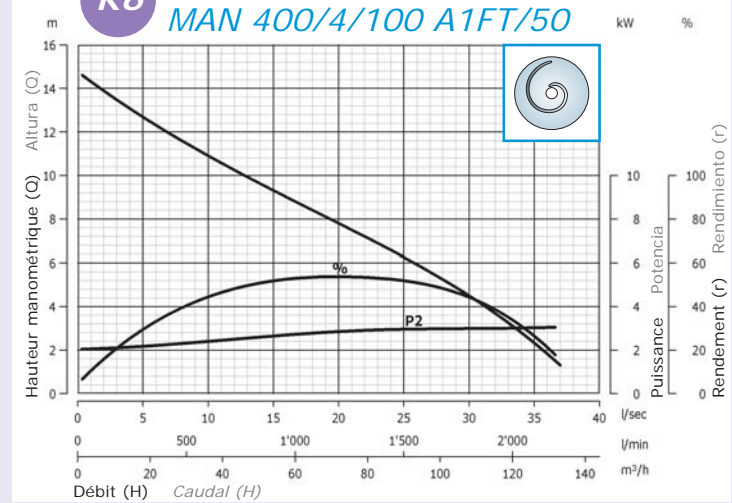

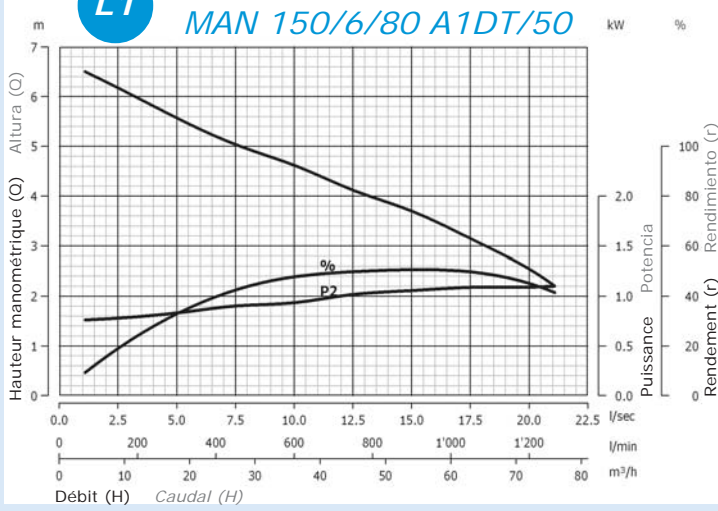
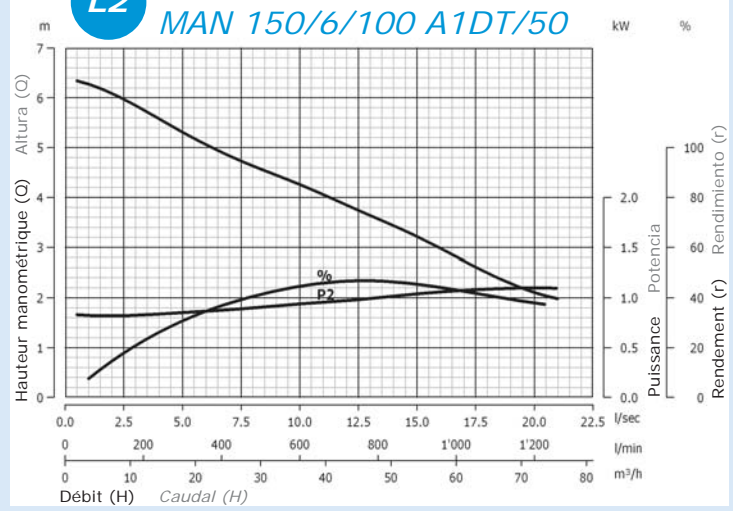
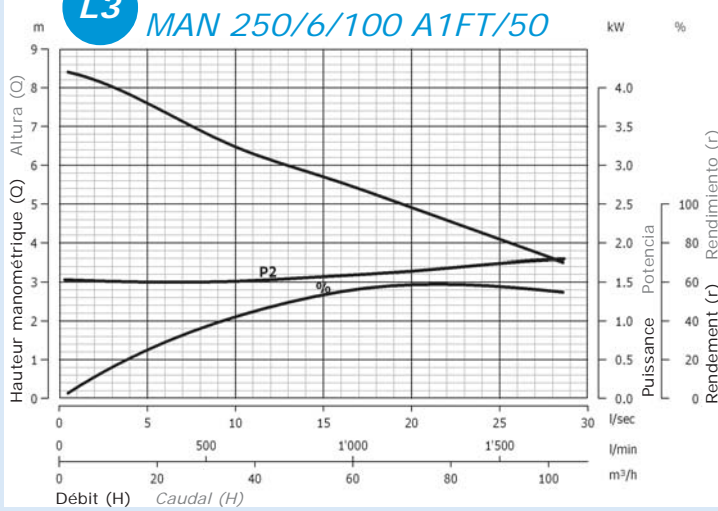
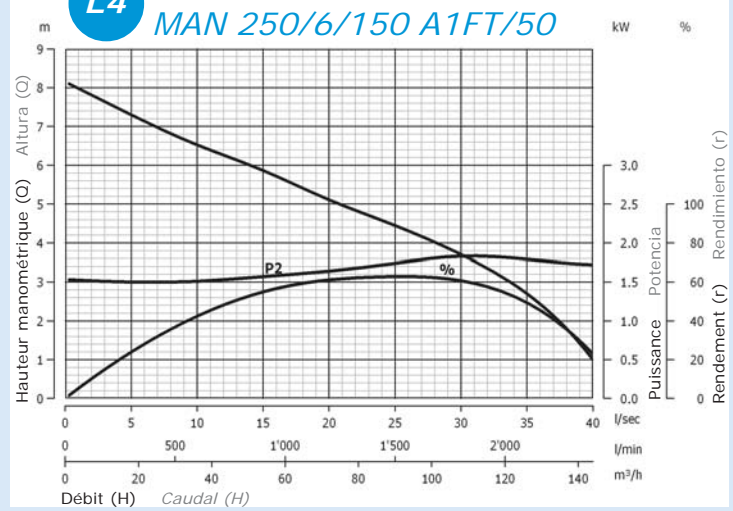
L1**MAN 150/6/80 A1DT/50****L2****MAN 150/6/100 A1DT/50****L3****MAN 250/6/100 A1FT/50****L4****MAN 250/6/150 A1FT/50**

Données hydrauliques - MAN

Datos hidráulicos - MAN

		l/s	0	3	6	9	12	15	18	21	24	27	30	33	36	40
		l/min	0	180	360	540	720	900	1080	1260	1440	1620	1800	1980	2160	2400
		m³/h	0	10.8	21.6	32.4	43.2	54	64.8	7.6	86.4	97.2	108	118.8	129.6	144
J1	MAN 250/2/G65V A1DM(T)	18.4	15.3	11.8	8.5	5.8	3.1									
J2	MAN 250/2/65 A1DM(T)	17.8	15	12.1	9	6.4	3.6									
J3	MAN 300/2/G65V A1DT	20.6	17.2	13.7	10.5	7.7	4.4									
J4	MAN 300/2/65 A1DT	22.2	18.7	15.5	12.6	9.8	6.7	3.8								
J5	MAN 400/2/65 A1FT	20.8	18.4	15.7	13.1	10.9	8.6	5.8	3.4							
J6	MAN 550/2/65 A1FT	28.3	25.3	22.8	20.4	18.1	15.6	12.9	10	7						
J7	MAN 250/2/80 A1DM(T)	18.5	15.2	12.1	9.3	6.5	4.2	1.8								
J8	MAN 300/2/80 A1DT	23.3	18.8	15.6	12.8	9.9	6.8	4.2	2.5							
J9	MAN 400/2/80 A1FT	21.1	18.5	15.8	13	10.4	7.9	5.4	2.8							
J10	MAN 400/2/100 A1FT	19.7	17.9	15.6	13.3	11.2	9.3	7.3	5.3	3.6						
J11	MAN 550/2/80 A1FT	30.2	26.6	23.6	20.9	18.3	15.9	13.4	10.7	7.7	4.4					
J12	MAN 550/2/100 A1FT	24.4	21.6	19.1	16.9	15.1	13.5	11.7	10.1	8.5	6.9	5.3				
K1	MAN 200/4/80 A1DT	10.2	9.2	8.3	7.5	6.8	6	5.2	4.3	3.4						
K2	MAN 200/4/100 A1DT	9.5	8.6	7.7	6.7	5.8	5	4.1	3.2							
K3	MAN 300/4/80 A1FT	13.4	12.1	11.1	10.2	9.4	8.6	7.8	6.9	6	5.2					
K4	MAN 300/4/100 A1FT	13.5	12.5	11.3	10.2	9.2	8.4	7.6	6.7	5.9	5					
K5	MAN 400/4/80 A1FT	15.8	14.4	13.3	12.4	11.7	11	10.3	9.5	8.6	7.7	6.7	5.9			
K6	MAN 400/4/100 A1FT	14.6	13.5	12.3	11.2	10.2	9.3	8.4	7.5	6.6	5.6	4.5	3.3	1.8		
L1	MAN 150/6/80 A1DT	6.7	6.1	5.3	4.8	4.2	3.7	3	2.2							
L2	MAN 150/6/100 A1DT	6.4	5.8	5.1	4.4	3.8	3.2	2.5	2							
L3	MAN 250/6/100 A1FT	8.4	8	7.4	6.7	6.1	5.7	5.2	4.7	4.3	3.8					
L4	MAN 250/6/150 A1FT	8.1	7.6	7.1	6.7	6.3	5.9	5.4	5	4.6	4.2	3.7	3.2	2.4	1	

Tableau données techniques - MAN

Tabla de datos técnicos - MAN

Corbe Curva	Code Código	Modèle Modelo	Refolement Caudal	Passage libre Paso libre (mm)	Puissance (kW) Potencia (kW)		Pôles Polos	V/~	Courant (A) Corrente (A)		Câble(*) Cable(*)		Kg
					P1	P2			Run	Start	Std	EX	
J1	0849	MAN 250/2/G65V A1DM/50	GAS 65V	40	2.6	1.8	2	230/1	12.5	55.4	A	B	52
J1	0850	MAN 250/2/G65V A1DT/50	GAS 65V	40	2.2	1.8	2	400/3	4.3	17.2	A	B	52
J2	0839	MAN 250/2/65 A1DM/50	DN 65	40	2.6	1.8	2	230/1	12.5	55.4	A	B	58
J2	0555	MAN 250/2/65 A1DT/50	DN 65	40	2.2	1.8	2	400/3	4.3	17.2	A	B	58
J3	0851	MAN 300/2/G65V A1DT/50	GAS 65V	40	2.8	2.2	2	400/3	5.1	22.2	A	B	52
J4	0556	MAN 300/2/65 A1DT/50	DN 65	40	2.8	2.2	2	400/3	5.1	22.2	A	B	58
J5	0558	MAN 400/2/65 A1FT/50	DN 65	50	4.0	3.0	2	400/3	6.7	29.7	A	C	74
J6	0561	MAN 550/2/65 A1FT/50	DN 65	50	5.2	4.1	2	400/3	8.7	38.5	A	C	77
J7	0840	MAN 250/2/80 A1DM/50	DN 80	40	2.6	1.8	2	230/1	12.5	55.4	A	B	56
J7	0570	MAN 250/2/80 A1DT/50	DN 80	40	2.2	1.8	2	400/3	4.3	17.2	A	B	56
J8	0557	MAN 300/2/80 A1DT/50	DN 80	40	2.8	2.2	2	400/3	5.1	22.2	A	B	58
J9	0559	MAN 400/2/80 A1FT/50	DN 80	50	4.0	3.0	2	400/3	6.7	29.7	A	C	74
J10	0560	MAN 400/2/100 A1FT/50	DN 100	50	4.0	3.0	2	400/3	6.7	29.7	A	C	82
J11	0562	MAN 550/2/80 A1FT/50	DN 80	50	5.2	4.1	2	400/3	8.7	38.5	A	C	77
J12	0563	MAN 550/2/100 A1FT/50	DN 100	55	5.2	4.1	2	400/3	8.7	38.5	A	C	85
K1	0564	MAN 200/4/80 A1DT/50	DN 80	80	2.0	1.5	4	400/3	4.1	18.1	A	B	66
K2	0565	MAN 200/4/100 A1DT/50	DN 100	80	2.0	1.5	4	400/3	4.1	18.1	A	B	68
K3	0566	MAN 300/4/80 A1FT/50	DN 80	80	2.9	2.2	4	400/3	5.8	25.7	A	C	86
K4	0567	MAN 300/4/100 A1FT/50	DN 100	80	2.9	2.2	4	400/3	5.8	25.7	A	C	88
K5	0568	MAN 400/4/80 A1FT/50	DN 80	80	3.8	3.0	4	400/3	7.3	32.3	A	C	89
K6	0569	MAN 400/4/100 A1FT/50	DN 100	80	3.8	3.0	4	400/3	7.3	32.3	A	C	91
L1	0852	MAN 150/6/80 A1DT	DN 80	80	1.6	1.1	6	400/3	3.7	15.9	A	B	65
L2	0853	MAN 150/6/100 A1DT	DN 100	80	1.6	1.1	6	400/3	3.7	15.9	A	B	67
L3	0854	MAN 250/6/100 A1FT	DN 100	100	2.8	1.8	6	400/3	5.7	27.5	A	C	111
L4	0855	MAN 250/6/150 A1FT	DN 150	100	2.8	1.8	6	400/3	5.7	27.5	A	C	114

Dimensions d'encombrement

Dimensiones máximas

Installation avec BASE (DRN-DGN-MAN)

Instalación con BASE (DRN-DGN-MAN)

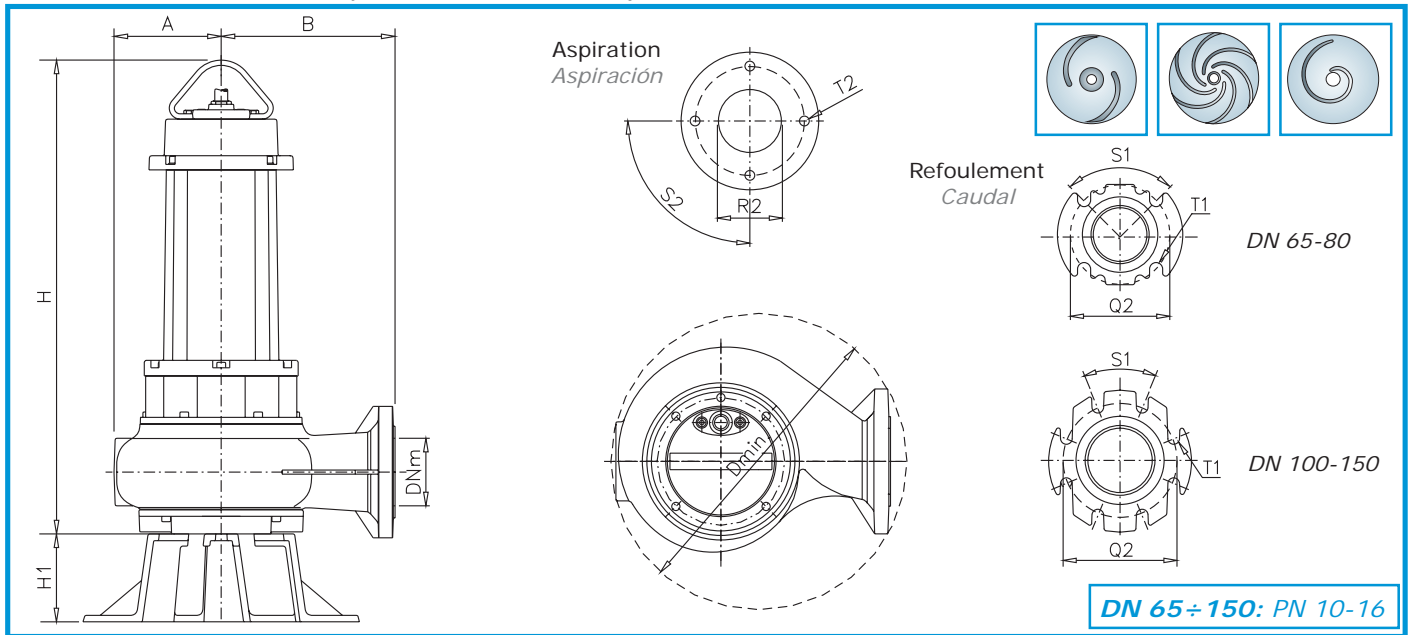

	A	B	Dmin	DNm	H	H1	Q2	R2	S1°	S2°	T1	T2
	mm	mm	mm	mm	mm	mm	mm	mm			mm	
DRN 250/2/65 A1DM(T)/50	136	208	373	65	552	124	145	65	90	90	18	M12
DRN 250/2/80 A1DM(T)/50	135	210	375	80	552	124	160	76	90	90	16	M12
DRN 300/2/65 A1DT/50	136	208	373	65	552	124	145	65	90	90	18	M12
DRN 300/2/80 A1DT/50	135	210	375	80	552	124	160	76	90	90	16	M12
DRN 400/2/65 A1FT/50	136	208	373	65	687	145	145	65	90	90	18	M12
DRN 400/2/80 A1FT/50	135	210	375	80	687	145	160	76	90	90	16	M12
DRN 400/2/100 A1FT/50	168	260	462	100	706	145	180	89	45	90	18	M16
DRN 550/2/65 A1FT/50	136	208	373	65	687	145	145	65	90	90	18	M12
DRN 550/2/80 A1FT/50	135	210	375	80	687	145	160	76	90	90	16	M12
DRN 550/2/100 A1FT/50	168	260	462	100	706	145	180	89	45	90	18	M16
DRN 200/4/80 A1DT/50	151	244	375	80	597	145	160	108	90	90	16	M16
DRN 200/4/100 A1DT/50	160	255	450	100	597	145	180	108	45	90	18	M16
DRN 300/4/80 A1FT/50	151	244	423	80	700	145	160	108	90	90	18	M16
DRN 300/4/100 A1FT/50	160	255	450	100	700	145	180	108	45	90	18	M16
DRN 400/4/80 A1FT/50	151	244	423	80	700	145	160	108	90	90	18	M16
DRN 400/4/100 A1FT/50	160	255	450	100	700	145	180	108	45	90	18	M16
DRN 150/6/80 A1DT/50	150	245	425	80	600	145	160	90	45	90	18	M16
DRN 150/6/100 A1DT/50	160	258	450	100	600	145	180	90	45	90	18	M16
DRN 250/6/100 A1FT/50	205	308	538	100	742	145	180	100	45	90	18	M16
DRN 250/6/150 A1FT/50	205	310	555	150	742	145	240	100	45	90	24	M16

	A	B	Dmin	DNm	H	H1	Q2	R2	S1°	S2°	T1	T2
	mm	mm	mm	mm	mm	mm	mm	mm			mm	
DGN 250/2/65 A1DM(T)/50	119	183	334	65	564	124	145	65	90	90	18	M12
DGN 250/2/80 A1DM(T)/50	120	190	350	80	590	124	160	89	90	90	18	M16
DGN 300/2/65 A1DT/50	129	193	347	65	584	124	145	65	90	90	18	M12
DGN 300/2/80 A1DT/50	127	190	356	80	591	124	160	89	90	90	18	M16
DGN 400/2/65 A1FT/50	129	193	347	65	718	124	145	65	90	90	18	M12
DGN 400/2/80 A1FT/50	127	190	356	80	726	124	160	89	90	90	18	M16
DGN 550/2/65 A1FT/50	129	193	347	65	718	124	145	65	90	90	18	M12
DGN 550/2/80 A1FT/50	127	190	356	80	726	124	160	89	90	90	18	M16
DGN 200/4/65 A1DT/50	156	235	420	65	600	145	145	65	90	90	18	M12
DGN 200/4/80 A1DT/50	155	230	416	80	617	145	160	89	90	90	18	M16
DGN 200/4/100 A1DT/50	160	255	450	100	638	145	180	108	45	90	18	M16
DGN 300/4/65 A1FT/50	156	235	420	65	702	145	145	65	90	90	18	M12
DGN 300/4/80 A1FT/50	155	230	416	80	720	145	160	89	90	90	18	M16
DGN 300/4/100 A1FT/50	160	255	450	100	742	145	180	108	45	90	18	M16
DGN 400/4/65 A1FT/50	156	235	347	65	584	145	145	65	90	90	18	M12
DGN 400/4/80 A1FT/50	155	230	416	80	720	145	160	89	90	90	18	M16
DGN 400/4/100 A1FT/50	160	255	450	100	742	145	180	108	45	90	18	M16
DGN 150/6/65 A1DT/50	156	238	420	65	600	145	145	65	90	90	18	M12
DGN 150/6/80 A1DT/50	158	233	420	80	620	145	160	80	45	90	18	M16
DGN 150/6/100 A1DT/50	158	253	525	100	442	145	180	100	45	90	18	M16
DGN 250/6/100 A1FT/50	192	330	525	100	770	145	180	100	45	90	18	M16
DGN 250/6/150 A1FT/50	217	314	600	150	825	145	240	150	45	90	18	M16

	A	B	Dmin	DNm	H	H1	Q2	R2	S1°	S2°	T1	T2
	mm	mm	mm	mm	mm	mm	mm	mm			mm	
MAN 250/2/65 A1DM(T)/50	136	208	373	65	552	124	145	65	90	90	18	M12
MAN 250/2/80 A1DM(T)/50	135	210	375	80	552	124	160	76	90	90	16	M12
MAN 300/2/65 A1DT/50	136	208	373	65	552	124	145	65	90	90	18	M12
MAN 300/2/80 A1DT/50	135	210	375	80	552	124	160	76	90	90	16	M12
MAN 400/2/65 A1FT/50	136	208	373	65	687	145	145	65	90	90	18	M12
MAN 400/2/80 A1FT/50	135	210	375	80	687	145	160	76	90	90	16	M12
MAN 400/2/100 A1FT/50	168	260	462	100	706	145	180	89	45	90	18	M16
MAN 550/2/65 A1FT/50	136	208	373	65	687	145	145	65	90	90	18	M12
MAN 550/2/80 A1FT/50	135	210	375	80	687	145	160	76	90	90	16	M12
MAN 550/2/100 A1FT/50	168	260	462	100	706	145	180	89	45	90	18	M16
MAN 200/4/80 A1DT/50	151	244	375	80	597	145	160	108	90	90	16	M16
MAN 200/4/100 A1DT/50	160	255	450	100	597	145	180	108	45	90	18	M16
MAN 300/4/80 A1FT/50	151	244	423	80	700	145	160	108	90	90	18	M16
MAN 300/4/100 A1FT/50	160	255	450	100	700	145	180	108	45	90	18	M16
MAN 400/4/80 A1FT/50	151	244	423	80	700	145	160	108	90	90	18	M16
MAN 400/4/100 A1FT/50	160	255	450	100	700	145	180	108	45	90	18	M16
MAN 150/6/80 A1DT/50	150	245	425	80	600	145	160	90	45	90	18	M16
MAN 150/6/100 A1DT/50	160	258	450	100	600	145	180	90	45	90	18	M16
MAN 250/6/100 A1FT/50	205	308	538	100	742	145	180	100	45	90	18	M16
MAN 250/6/150 A1FT/50	205	310	555	150	742	145	240	100	45	90	24	M16

Installation avec BASE (DGN-MAN)

Instalacion con BASE (DGN-MAN)

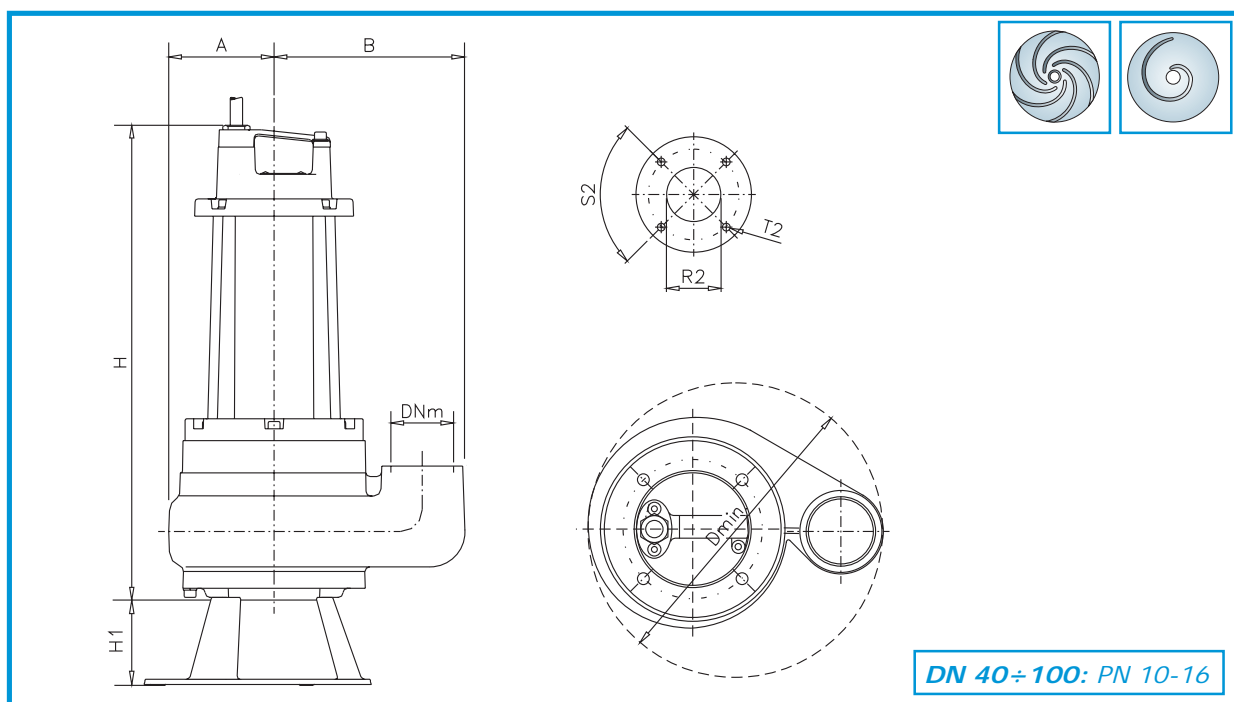

	A	B	Dmin	DNm	H	H1	R2	S2°	T2
	mm	mm	mm	inch	mm	mm	mm	°	
DGN 250/2/G65V A1DM(T)/50	109	203	310	2 1/2	564	124	76	90	M12
DGN 300/2/G65V A1DT/50	109	203	310	2 1/2	564	124	76	90	M12

	A	B	Dmin	DNm	H	H1	R2	S2°	T2
	mm	mm	mm	inch	mm	mm	mm	°	
MAN 250/2/G65V A1DT/50	109	203	310	2 1/2	564	124	76	90	M12
MAN 300/2/G65V A1DT/50	109	203	310	2 1/2	564	124	76	90	M12

Installation avec BASE (GRN-APN)

Instalacion con BASE (GRN-APN)

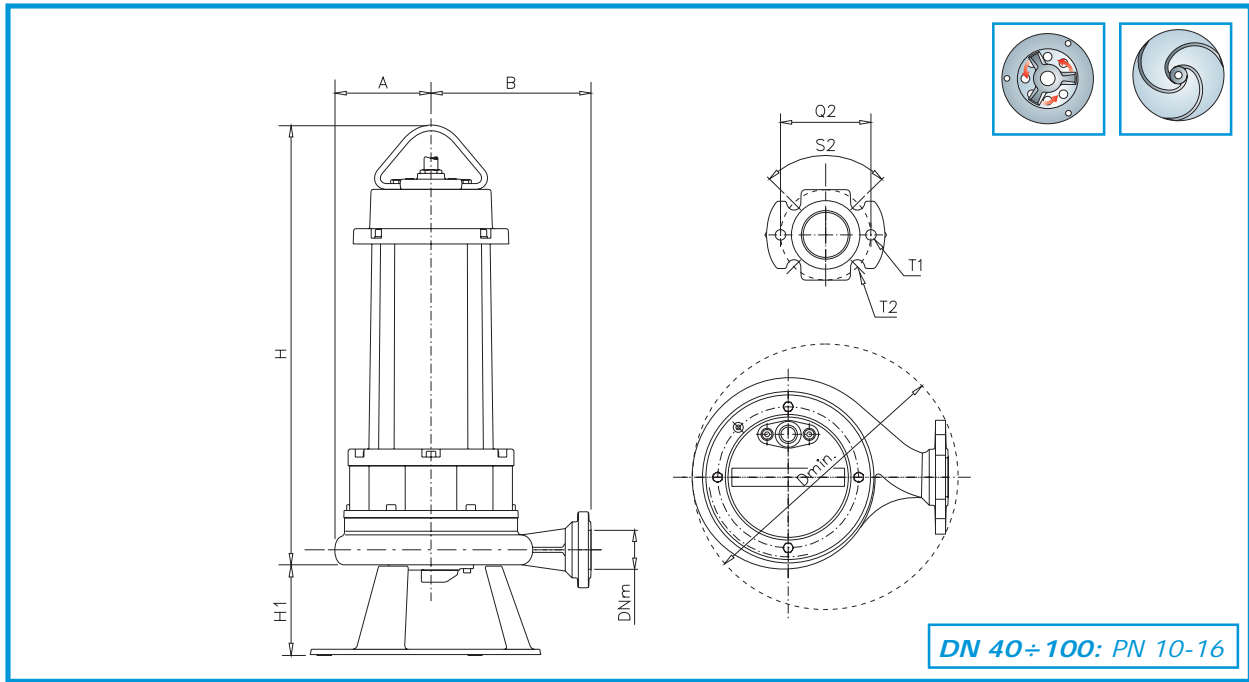

	A	B	Dmin	DNm	H	H1	Q2	S2	DV	T1	T2
	mm	mm	mm	mm	mm	mm	mm	mm	mm	mm	mm
GRN 250/2/G40H A1DM(T)/50	107	160	546	1 1/2	498	124	150	90	91	M12	14
GRN 300/2/G50H A1DT/50	110	195	318	2	500	124	150	90	91	M12	14
GRN 400/2/G50H A1FT/50	132	220	360	2	629	124	150	90	91	M12	14
GRN 550/2/G50H A1FT/50	132	220	360	2	629	124	150	90	91	M12	14

	A	B	Dmin	DNm	H	H1	Q2	S2	DV	T1	T2
	mm	mm	mm	mm	mm	mm	mm	mm	mm	mm	mm
APN 250/2/G40H A1DM(T)/50	107	160	546	1 1/2	534	124	150	90	91	M12	14
APN 300/2/G50H A1DT/50	110	195	318	2	536	124	150	90	91	M12	14
APN 400/2/G50H A1FT/50	132	220	360	2	660	124	150	90	91	M12	14
APN 550/2/G50H A1FT/50	132	220	360	2	660	124	150	90	91	M12	14

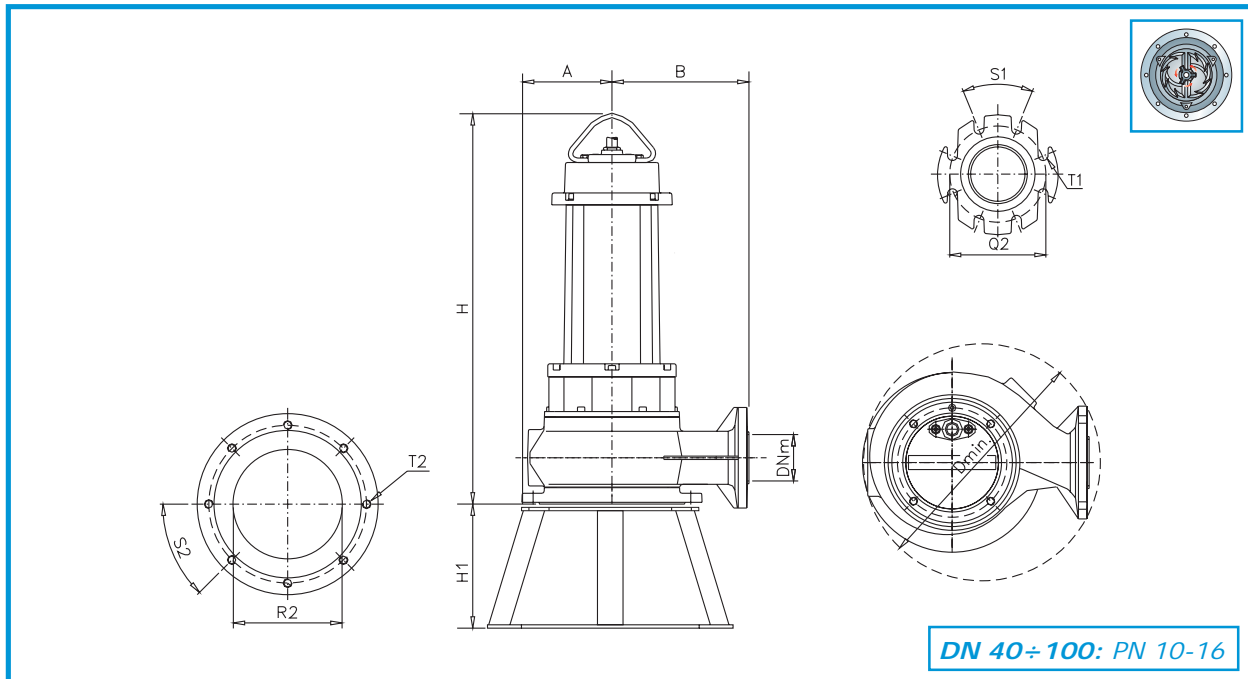

	A	B	Dmin	DNm	H	H1	Q2	R2	S1	S2	T1	T2
	mm	mm	mm	mm	mm	mm	mm	mm	°	°	mm	mm
GRN 300/4/80 A1FT/50	160	244	423	80	693	250	160	216	90	45	18	M16
GRN 300/4/100 A1FT/50	160	255	450	100	693	250	180	216	45	45	18	M16
GRN 400/4/80 A1FT/50	160	244	423	80	693	250	160	216	90	45	18	M16
GRN 400/4/100 A1FT/50	160	255	450	100	693	250	180	216	45	45	18	M16

Installation avec BASE
Instalacion con BASE

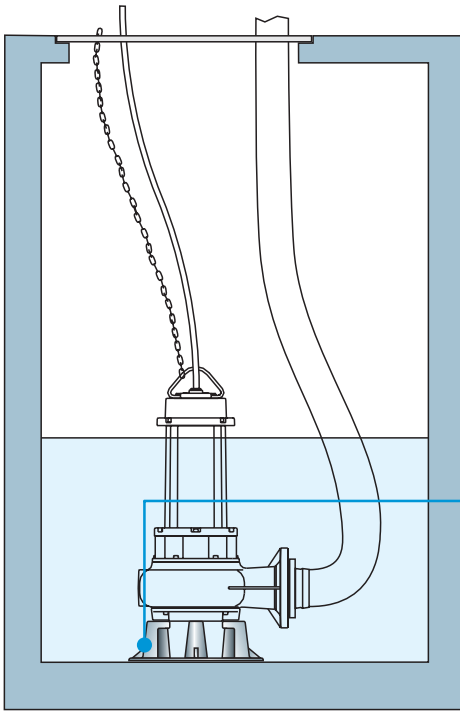

Embase en fonte sphéroïdale
Base de fundición esferoidal

Version GRINDER 2 pôles
Versión GRINDER de 2 polos

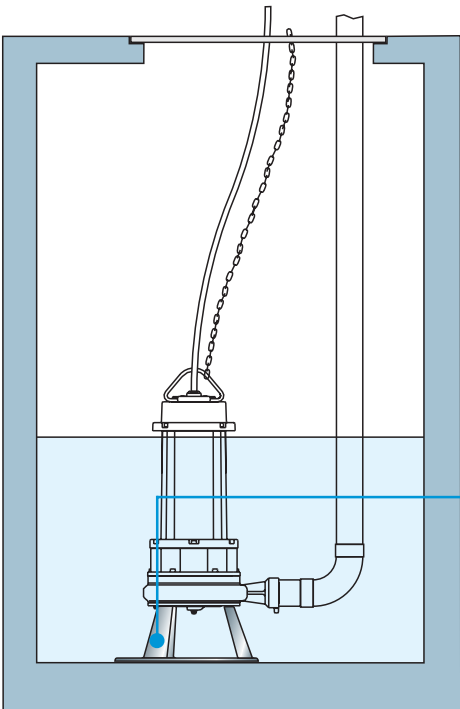

Embase en fonte sphéroïdale
Base de fundición esferoidal

Version GRINDER 4 pôles
Versión GRINDER de 4 polos

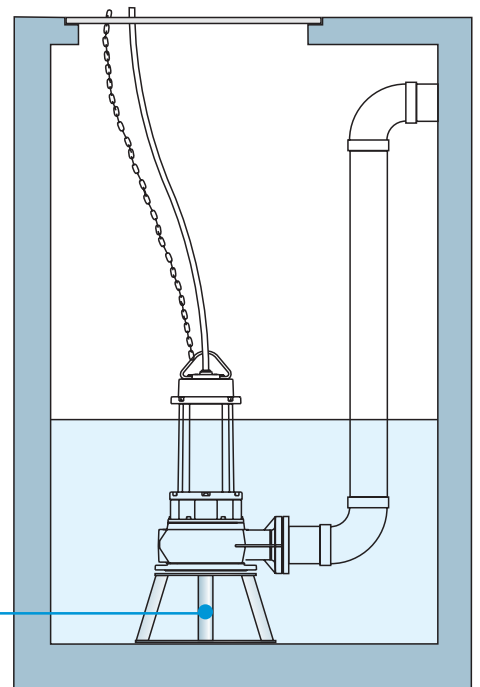

Installation avec DISPOSITIF D'ACCOUPLMENT HORIZONTAL (DRN - DGN - MAN)

Instalación con DISPOSITIVO DE ACOPLAMIENTO HORIZONTAL (DRN - DGN - MAN)

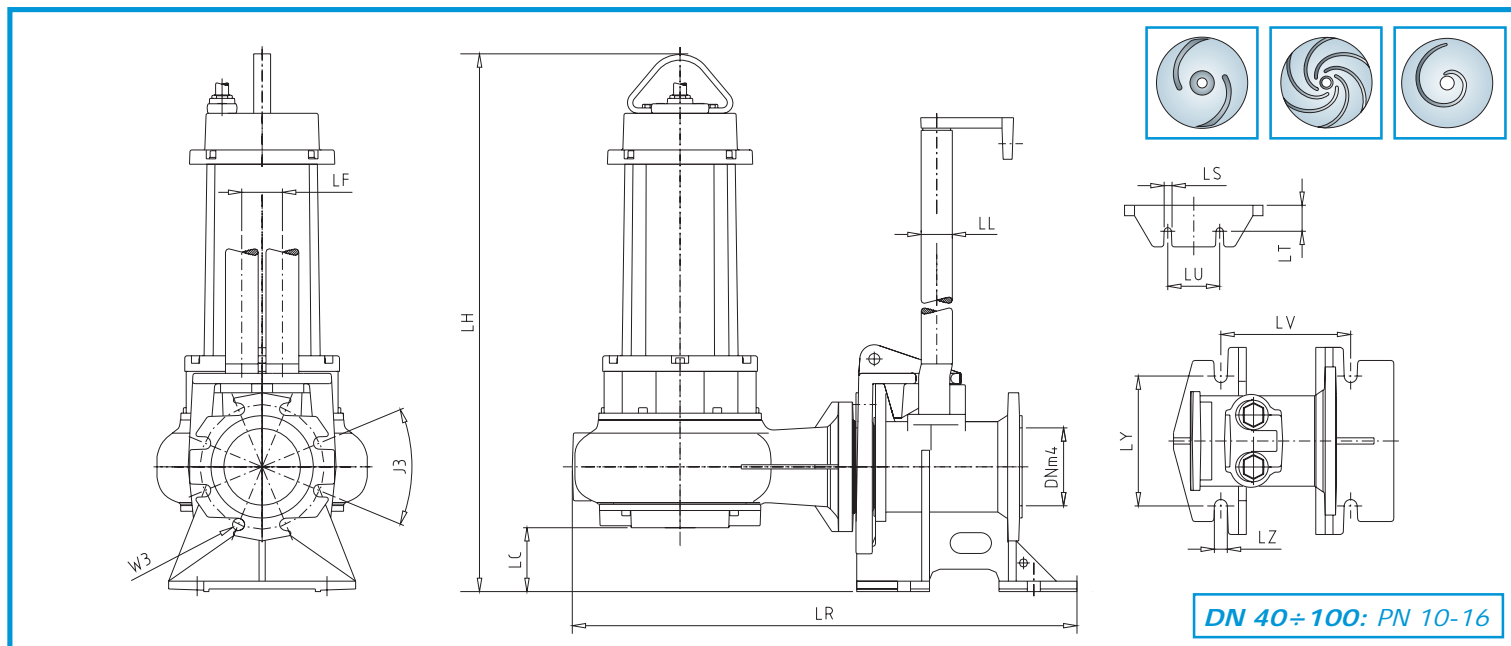

	DNm4	J3	LC	LF	LH	LL	LR	LS	LT	LU	LV	LY	LZ	W3
	mm	°	mm	mm	mm	inch	mm	mm	mm	mm	mm	mm	mm	mm
DRN 250/2/65 A1DM(T)/50	65	90	102	100	654	2	657	14	50	100	250	200	14	18
DRN 250/2/80 A1DM(T)/50	80	90	110	100	662	2	658	14	50	100	250	200	14	18
DRN 300/2/65 A1DT/50	65	90	102	100	654	2	657	14	50	100	250	200	14	18
DRN 300/2/80 A1DT/50	80	90	110	100	662	2	658	14	50	100	250	200	14	18
DRN 400/2/65 A1FT/50	65	90	102	100	789	2	657	14	50	100	250	200	14	18
DRN 400/2/80 A1FT/50	80	90	110	100	799	2	658	14	50	100	250	200	14	18
DRN 400/2/100 A1FT/50	100	45	99	100	807	2	750	14	50	100	250	200	16	18
DRN 550/2/65 A1FT/50	65	90	102	100	789	2	657	14	50	100	250	200	14	18
DRN 550/2/80 A1FT/50	80	90	110	100	799	2	658	14	50	100	250	200	14	18
DRN 550/2/100 A1FT/50	100	45	99	100	807	2	750	14	50	100	250	200	16	18
DRN 200/4/80 A1DT/50	80	90	101	100	698	2	708	14	50	100	250	200	14	18
DRN 200/4/100 A1DT/50	100	45	99	100	696	2	737	14	50	100	250	200	16	18
DRN 300/4/80 A1FT/50	80	90	101	100	802	2	708	14	50	100	250	200	14	18
DRN 300/4/100 A1FT/50	100	45	99	100	800	2	737	14	50	100	250	200	16	18
DRN 400/4/80 A1FT/50	80	90	101	100	802	2	708	14	50	100	250	200	14	18
DRN 400/4/100 A1FT/50	100	45	99	100	800	2	737	14	50	100	250	200	16	18
DRN 150/6/80 A1DT/50	80	90	101	100	700	2	700	14	50	100	250	200	14	18
DRN 150/6/100 A1DT/50	100	45	100	100	700	2	740	14	50	100	250	200	16	18
DRN 250/6/100 A1FT/50	100	45	77	100	820	2	835	14	50	100	250	200	16	18
DRN 250/6/150 A1FT/50	150	45	126	100	870	2	920	14	50	100	250	250	25	24

	DNm4	J3	LC	LF	LH	LL	LR	LS	LT	LU	LV	LY	LZ	W3
	mm	°	mm	mm	mm	inch	mm	mm	mm	mm	mm	mm	mm	mm
DGN 250/2/65 A1DM(T)/50	65	90	120	100	684	2	615	14	50	100	250	200	14	18
DGN 250/2/80 A1DM(T)/50	80	90	110	100	700	2	623	14	50	100	250	200	14	18
DGN 300/2/65 A1DT/50	65	90	102	100	685	2	635	14	50	100	250	200	14	18
DGN 300/2/80 A1DT/50	80	90	110	100	701	2	630	14	50	100	250	200	14	18
DGN 400/2/65 A1FT/50	65	90	102	100	820	2	635	14	50	100	250	200	14	18
DGN 400/2/80 A1FT/50	80	90	110	100	837	2	630	14	50	100	250	200	14	18
DGN 550/2/65 A1FT/50	65	90	102	100	820	2	635	14	50	100	250	200	14	18
DGN 550/2/80 A1FT/50	80	90	110	100	837	2	630	14	50	100	250	200	14	18
DGN 200/4/65 A1DT/50	65	90	112	100	712	2	704	14	50	100	250	200	14	18
DGN 200/4/80 A1DT/50	80	90	110	100	727	2	698	14	50	100	250	200	14	18
DGN 200/4/100 A1DT/50	100	45	99	100	737	2	737	14	50	100	250	200	16	18
DGN 300/4/65 A1FT/50	65	90	112	100	814	2	704	14	50	100	250	200	14	18
DGN 300/4/80 A1FT/50	80	90	110	100	830	2	698	14	50	100	250	200	14	18
DGN 300/4/100 A1FT/50	100	45	99	100	841	2	737	14	50	100	250	200	16	18
DGN 400/4/65 A1FT/50	65	90	112	100	814	2	704	14	50	100	250	200	14	18
DGN 400/4/80 A1FT/50	80	90	110	100	830	2	698	14	50	100	250	200	14	18
DGN 400/4/100 A1FT/50	100	45	99	100	841	2	737	14	50	100	250	200	16	18
DGN 150/6/65 A1DT/50	65	90	113	100	712	2	705	14	50	100	250	200	14	18
DGN 150/6/80 A1DT/50	80	90	110	100	730	2	695	14	50	100	250	200	14	18
DGN 150/6/100 A1DT/50	100	45	99	100	737	2	731	14	50	100	250	200	16	18
DGN 250/6/100 A1FT/50	100	45	99	100	870	2	820	14	50	100	250	200	16	18
DGN 250/6/150 A1FT/50	150	45	118	100	935	2	944	14	50	100	250	250	25	24

	DNm4 mm	J3 °	LC mm	LF mm	LH mm	LL inch	LR mm	LS mm	LT mm	LU mm	LV mm	LY mm	LZ mm	W3 mm
MAN 250/2/65 A1DM(T)/50	65	90	102	100	654	2	657	14	50	100	250	200	14	18
MAN 250/2/80 A1DM(T)/50	80	90	110	100	662	2	658	14	50	100	250	200	14	18
MAN 300/2/65 A1DT/50	65	90	102	100	654	2	657	14	50	100	250	200	14	18
MAN 300/2/80 A1DT/50	80	90	110	100	662	2	658	14	50	100	250	200	14	18
MAN 400/2/65 A1FT/50	65	90	102	100	789	2	657	14	50	100	250	200	14	18
MAN 400/2/80 A1FT/50	80	90	110	100	799	2	658	14	50	100	250	200	14	18
MAN 400/2/100 A1FT/50	100	45	99	100	807	2	750	14	50	100	250	200	16	18
MAN 550/2/65 A1FT/50	65	90	102	100	789	2	657	14	50	100	250	200	14	18
MAN 550/2/80 A1FT/50	80	90	110	100	799	2	658	14	50	100	250	200	14	18
MAN 550/2/100 A1FT/50	100	45	99	100	807	2	750	14	50	100	250	200	16	18
MAN 200/4/80 A1DT/50	80	90	101	100	698	2	708	14	50	100	250	200	14	18
MAN 200/4/100 A1DT/50	100	45	99	100	696	2	737	14	50	100	250	200	16	18
MAN 300/4/80 A1FT/50	80	90	101	100	802	2	708	14	50	100	250	200	14	18
MAN 300/4/100 A1FT/50	100	45	99	100	800	2	737	14	50	100	250	200	16	18
MAN 400/4/80 A1FT/50	80	90	101	100	802	2	708	14	50	100	250	200	14	18
MAN 400/4/100 A1FT/50	100	45	99	100	800	2	737	14	50	100	250	200	16	18
MAN 150/6/80 A1DT/50	80	90	101	100	700	2	700	14	50	100	250	200	14	18
MAN 150/6/100 A1DT/50	100	45	100	100	700	2	740	14	50	100	250	200	16	18
MAN 250/6/100 A1FT/50	100	45	77	100	820	2	835	14	50	100	250	200	16	18
MAN 250/6/150 A1FT/50	150	45	126	100	870	2	920	14	50	100	250	250	25	24

Installation avec DISPOSITIF D'ACCOUPLMENT HORIZONTAL (GRN - APN)
Instalación con DISPOSITIVO DE ACOPLAMIENTO HORIZONTAL (GRN - APN)

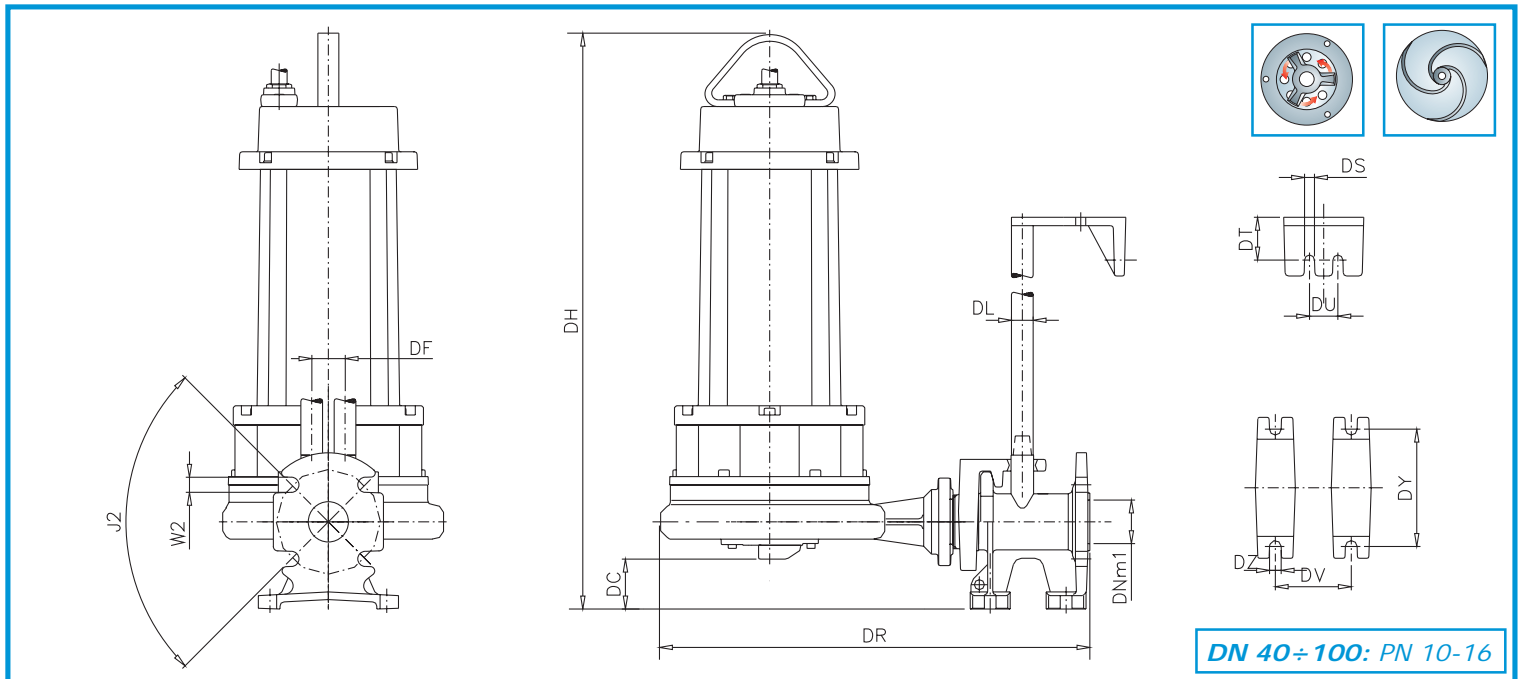

	DC mm	DF mm	DH mm	DL inch	DNm1 mm	DR mm	DS mm	DT mm	DU mm	DV mm	DY mm	DZ mm	J2 °	W2 mm
GRN 250/2/G40H A1DM(T)/50	62	40	561	3/4	40	420	12	51	34	91	140	14	90	18
GRN 300/2/G50H A1DT/50	62	40	561	3/4	50	470	12	51	34	91	140	14	90	18
GRN 400/2/G50H A1FT/50	58	40	687	3/4	50	517	12	51	34	91	140	14	90	18
GRN 550/2/G50H A1FT/50	58	40	687	3/4	50	517	12	51	34	91	140	14	90	18

	DC mm	DF mm	DH mm	DL inch	DNm1 mm	DR mm	DS mm	DT mm	DU mm	DV mm	DY mm	DZ mm	J2 °	W2 mm
APN 250/2/G40H A1DM(T)/50	28	40	561	3/4	40	420	12	51	34	91	140	14	90	18
APN 300/2/G50H A1DT/50	25	40	561	3/4	50	470	12	51	34	91	140	14	90	18
APN 400/2/G50H A1FT/50	27	40	687	3/4	50	517	12	51	34	91	140	14	90	18
APN 550/2/G50H A1FT/50	27	40	687	3/4	50	517	12	51	34	91	140	14	90	18

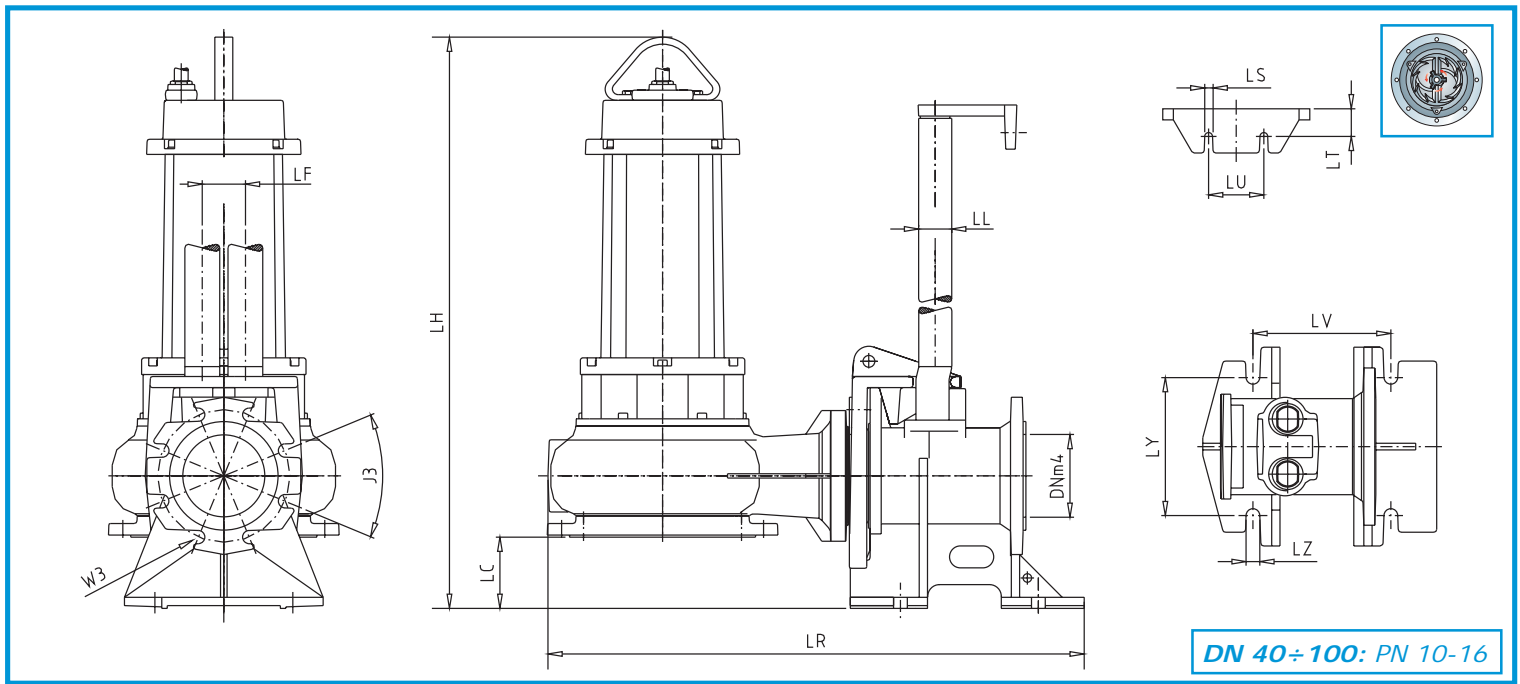

	DNm4	J3	LC	LF	LH	LL	LR	LS	LT	LU	LV	LY	LZ
	mm	°	mm	mm	mm	inch	mm	mm	mm	mm	mm	mm	mm
GRN 300/4/80 A1FT/50	80	90	108	100	801	2	717	14	50	100	250	200	14
GRN 300/4/100 A1FT/50	100	45	105	100	798	2	737	14	50	100	250	200	16
GRN 400/4/80 A1FT/50	80	90	108	100	801	2	717	14	50	100	250	200	14
GRN 400/4/100 A1FT/50	100	45	105	100	798	2	737	14	50	100	250	200	16

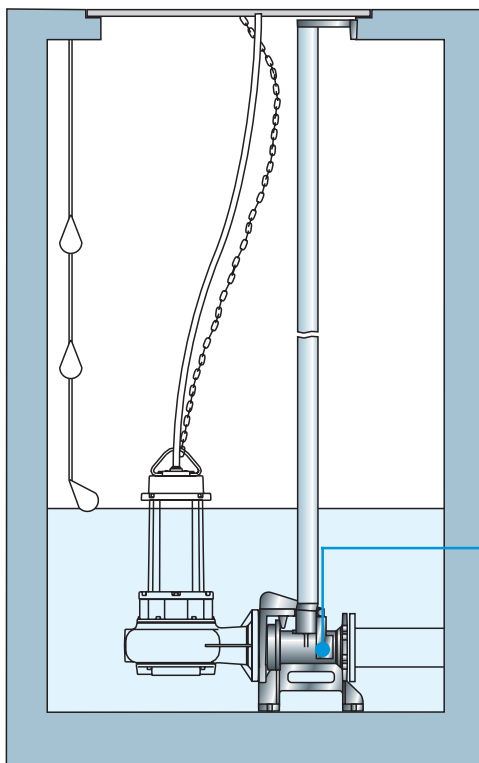

**BREVETÉ
PATENTADO**

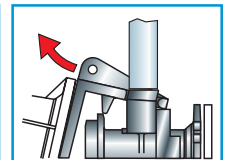
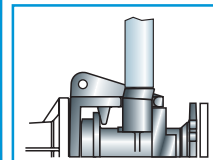

Dispositif d'accouplement de fond à refoulement horizontal
avec système de décrochage BREVETÉ
Dispositivo de acoplamiento de fondo con alimentación
horizontal y sistema de desenganche PATENTADO

Installation avec DISPOSITIF D'ACCOUPEMENT HORIZONTAL
Instalación con DISPOSITIVO DE ACOPLAMIENTO HORIZONTAL

Installation avec DISPOSITIF D'ACCOUPEMENT VERTICAL (DRN - DGN - MAN)

Instalación con DISPOSITIVO DE ACOPLAMIENTO VERTICAL (DRN - DGN - MAN)

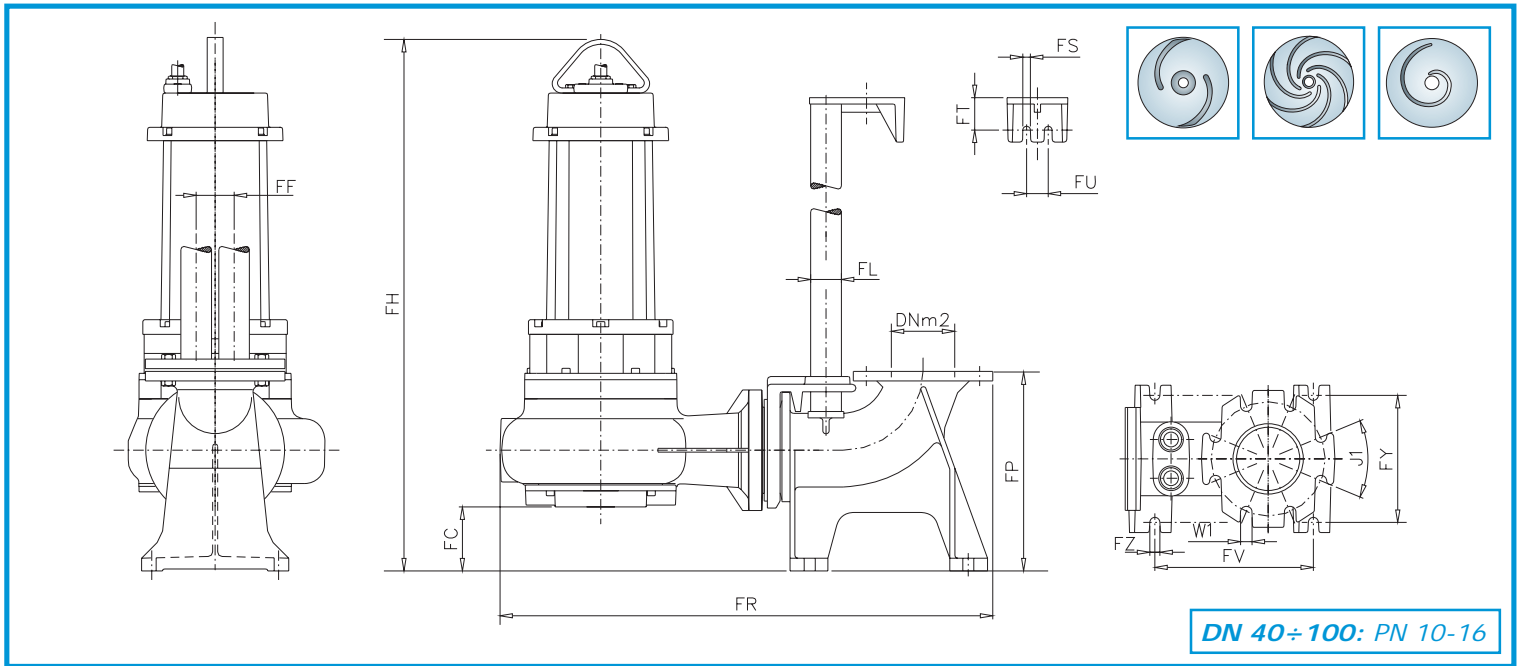

	DNm2	FC	FF	FH	FL	FR	FS	FT	FU	FV	FY	FZ	J1	W1
	mm	mm	mm	mm	inch	mm	mm	mm	mm	mm	mm	mm	°	mm
DRN 250/2/65 A1DM(T)/50	65	105	61	657	11/2	629	12	51	34	235	80	14	90	18
DRN 250/2/80 A1DM(T)/50	80	77	61	639	11/2	686	12	51	34	250	200	16	90	18
DRN 300/2/65 A1DT/50	65	105	61	657	11/2	629	12	51	34	235	80	14	90	18
DRN 300/2/80 A1DT/50	80	77	61	639	11/2	686	12	51	34	250	200	16	90	18
DRN 400/2/65 A1FT/50	65	105	61	792	11/2	629	12	51	34	235	80	14	90	18
DRN 400/2/80 A1FT/50	80	110	61	799	11/2	686	12	51	34	250	200	16	90	18
DRN 400/2/100 A1FT/50	100	99	61	807	11/2	791	12	51	34	250	200	16	45	22
DRN 550/2/65 A1FT/50	65	105	61	792	11/2	629	12	51	34	235	80	14	90	18
DRN 550/2/80 A1FT/50	80	110	61	799	11/2	686	12	51	34	250	200	16	90	18
DRN 550/2/100 A1FT/50	100	99	61	807	11/2	791	12	51	34	250	200	16	45	22
DRN 200/4/80 A1DT/50	80	101	61	698	11/2	736	12	51	34	250	200	16	90	18
DRN 200/4/100 A1DT/50	100	99	61	696	11/2	778	12	51	34	250	200	16	45	22
DRN 300/4/80 A1FT/50	80	101	61	802	11/2	736	12	51	34	250	200	16	90	18
DRN 300/4/100 A1FT/50	100	99	61	801	11/2	778	12	51	34	250	200	16	45	22
DRN 400/4/80 A1FT/50	80	101	61	802	11/2	736	12	51	34	250	200	16	90	18
DRN 400/4/100 A1FT/50	100	99	61	801	11/2	778	12	51	34	250	200	16	45	22
DRN 150/6/80 A1DT/50	80	101	61	700	11/2	735	12	51	34	250	200	16	90	18
DRN 150/6/100 A1DT/50	100	100	61	700	11/2	778	12	51	34	250	200	16	45	22
DRN 250/6/100 A1FT/50	100	76	61	820	11/2	877	12	51	34	250	200	16	45	22
DRN 250/6/150 A1FT/50	200	295	100	1036	2	1145	14	50	100	280	280	25	45	22

	DNm2	FC	FF	FH	FL	FR	FS	FT	FU	FV	FY	FZ	J1	W1
	mm	mm	mm	mm	inch	mm	mm	mm	mm	mm	mm	mm	°	mm
DGN 250/2/65 A1DM(T)/50	65	123	61	687	11/2	587	12	51	34	235	80	14	90	18
DGN 250/2/80 A1DM(T)/50	80	110	61	700	11/2	622	12	51	34	250	200	16	90	18
DGN 300/2/65 A1DT/50	65	105	61	688	11/2	607	12	51	34	235	80	14	90	18
DGN 300/2/80 A1DT/50	80	110	61	701	11/2	658	12	51	34	250	200	16	90	18
DGN 400/2/65 A1FT/50	65	105	61	823	11/2	607	12	51	34	235	80	14	90	18
DGN 400/2/80 A1FT/50	80	110	61	836	11/2	658	12	51	34	250	200	16	90	18
DGN 550/2/65 A1FT/50	65	105	61	823	11/2	607	12	51	34	235	80	14	90	18
DGN 550/2/80 A1FT/50	80	110	61	836	11/2	658	12	51	34	250	200	16	90	18
DGN 200/4/65 A1DT/50	65	115	61	715	11/2	676	12	51	34	235	80	14	90	18
DGN 200/4/80 A1DT/50	80	110	61	727	11/2	726	12	51	34	250	200	16	90	18
DGN 200/4/100 A1DT/50	100	99	61	737	11/2	778	12	51	34	250	200	16	45	22
DGN 300/4/65 A1FT/50	65	115	61	817	11/2	676	12	51	34	235	80	14	90	18
DGN 300/4/80 A1FT/50	80	110	61	830	11/2	726	12	51	34	250	200	16	90	18
DGN 300/4/100 A1FT/50	100	99	61	841	11/2	778	12	51	34	250	200	16	45	22
DGN 400/4/65 A1FT/50	65	115	61	817	11/2	676	12	51	34	235	80	14	90	18
DGN 400/4/80 A1FT/50	80	110	61	830	11/2	726	12	51	34	250	200	16	90	18
DGN 400/4/100 A1FT/50	100	99	61	841	11/2	778	12	51	34	250	200	16	45	22
DGN 150/6/65 A1DT/50	-	-	-	-	-	-	-	-	-	-	-	-	-	-
DGN 150/6/80 A1DT/50	80	110	61	730	11/2	730	12	51	34	250	200	16	90	18
DGN 150/6/100 A1DT/50	100	110	61	730	11/2	730	12	51	34	250	200	16	45	22
DGN 250/6/100 A1FT/50	100	99	61	870	11/2	860	12	51	34	250	200	16	45	22
DGN 250/6/150 A1FT/50	200	286	100	1112	2	1156	14	50	100	280	280	25	45	22

	DNm2	FC	FF	FH	FL	FR	FS	FT	FU	FV	FY	FZ	J1	W1
	mm	mm	mm	mm	inch	mm	mm	mm	mm	mm	mm	mm	°	mm
MAN 250/2/65 A1DM(T)/50	65	105	61	657	11/2	629	12	51	34	235	80	14	90	18
MAN 250/2/80 A1DM(T)/50	80	77	61	639	11/2	686	12	51	34	250	200	16	90	18
MAN 300/2/65 A1DT/50	65	105	61	657	11/2	629	12	51	34	235	80	14	90	18
MAN 300/2/80 A1DT/50	80	77	61	639	11/2	686	12	51	34	250	200	16	90	18
MAN 400/2/65 A1FT/50	65	105	61	792	11/2	629	12	51	34	235	80	14	90	18
MAN 400/2/80 A1FT/50	80	110	61	799	11/2	686	12	51	34	250	200	16	90	18
MAN 400/2/100 A1FT/50	100	99	61	807	11/2	791	12	51	34	250	200	16	45	22
MAN 550/2/65 A1FT/50	65	105	61	792	11/2	629	12	51	34	235	80	14	90	18
MAN 550/2/80 A1FT/50	80	110	61	799	11/2	686	12	51	34	250	200	16	90	18
MAN 550/2/100 A1FT/50	100	99	61	807	11/2	791	12	51	34	250	200	16	45	22
MAN 200/4/80 A1DT/50	80	101	61	698	11/2	736	12	51	34	250	200	16	90	18
MAN 200/4/100 A1DT/50	100	99	61	696	11/2	778	12	51	34	250	200	16	45	22
MAN 300/4/80 A1FT/50	80	101	61	802	11/2	736	12	51	34	250	200	16	90	18
MAN 300/4/100 A1FT/50	100	99	61	801	11/2	778	12	51	34	250	200	16	45	22
MAN 400/4/80 A1FT/50	80	101	61	802	11/2	736	12	51	34	250	200	16	90	18
MAN 400/4/100 A1FT/50	100	99	61	801	11/2	778	12	51	34	250	200	16	45	22
MAN 150/6/80 A1DT/50	80	101	61	700	11/2	735	12	51	34	250	200	16	90	18
MAN 150/6/100 A1DT/50	100	100	61	700	11/2	778	12	51	34	250	200	16	45	22
MAN 250/6/100 A1FT/50	100	76	61	820	11/2	877	12	51	34	250	200	16	45	22
MAN 250/6/150 A1FT/50	200	295	100	1036	2	1145	14	50	100	280	280	25	45	22

Installation avec DISPOSITIF D'ACCOUPEMENT VERTICAL (GRN - APN) Instalación con DISPOSITIVO DE ACOPLAMIENTO VERTICAL (GRN - APN)

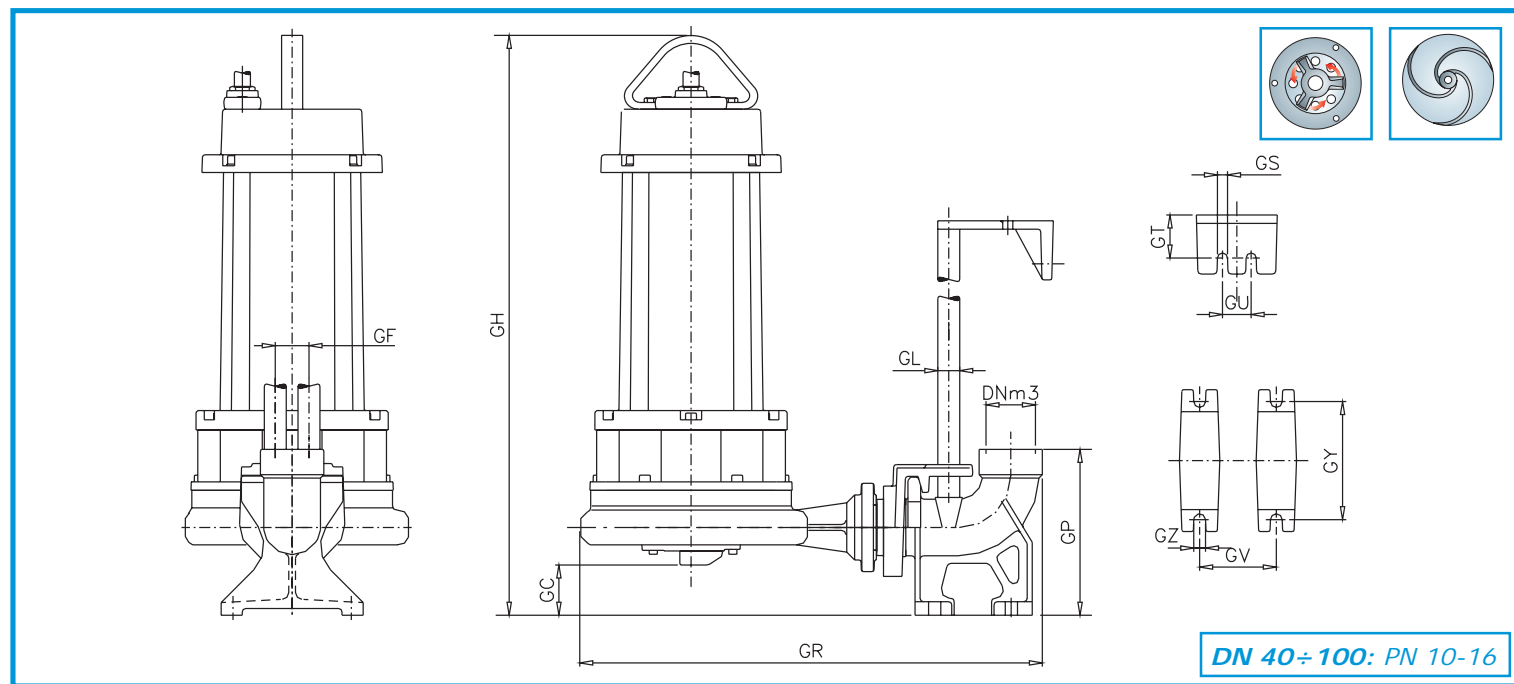

	GC	GF	GH	GL	DNm3	GP	GR	GS	GT	GU	GV	GY	GZ
	mm	mm	mm	inch	inch	mm	mm	mm	mm	mm	mm	mm	mm
GRN 250/2/G40H A1DM(T)/50	61	40	560	3/4	2-21/2	216	482	12	51	34	91	140	14
GRN 300/2/G50H A1DT/50	62	40	562	3/4	2	197	501	12	51	34	91	140	13
GRN 400/2/G50H A1FT/50	58	40	687	3/4	2	197	548	12	51	34	91	140	13
GRN 550/2/G50H A1FT/50	58	40	687	3/4	2	197	548	12	51	34	91	140	13

	GC	GF	GH	GL	DNm3	GP	GR	GS	GT	GU	GV	GY	GZ
	mm	mm	mm	inch	inch	mm	mm	mm	mm	mm	mm	mm	mm
APN 250/2/G40H A1GM(T)/50	26	40	560	3/4	2-21/2	216	482	12	51	34	91	140	14
APN 300/2/G50H A1GT/50	25	40	562	3/4	2	197	548	12	51	34	91	140	13
APN 400/2/G50H A1FT/50	27	40	687	3/4	2	197	548	12	51	34	91	140	13
APN 550/2/G50H A1FT/50	27	40	687	3/4	2	197	548	12	51	34	91	140	13

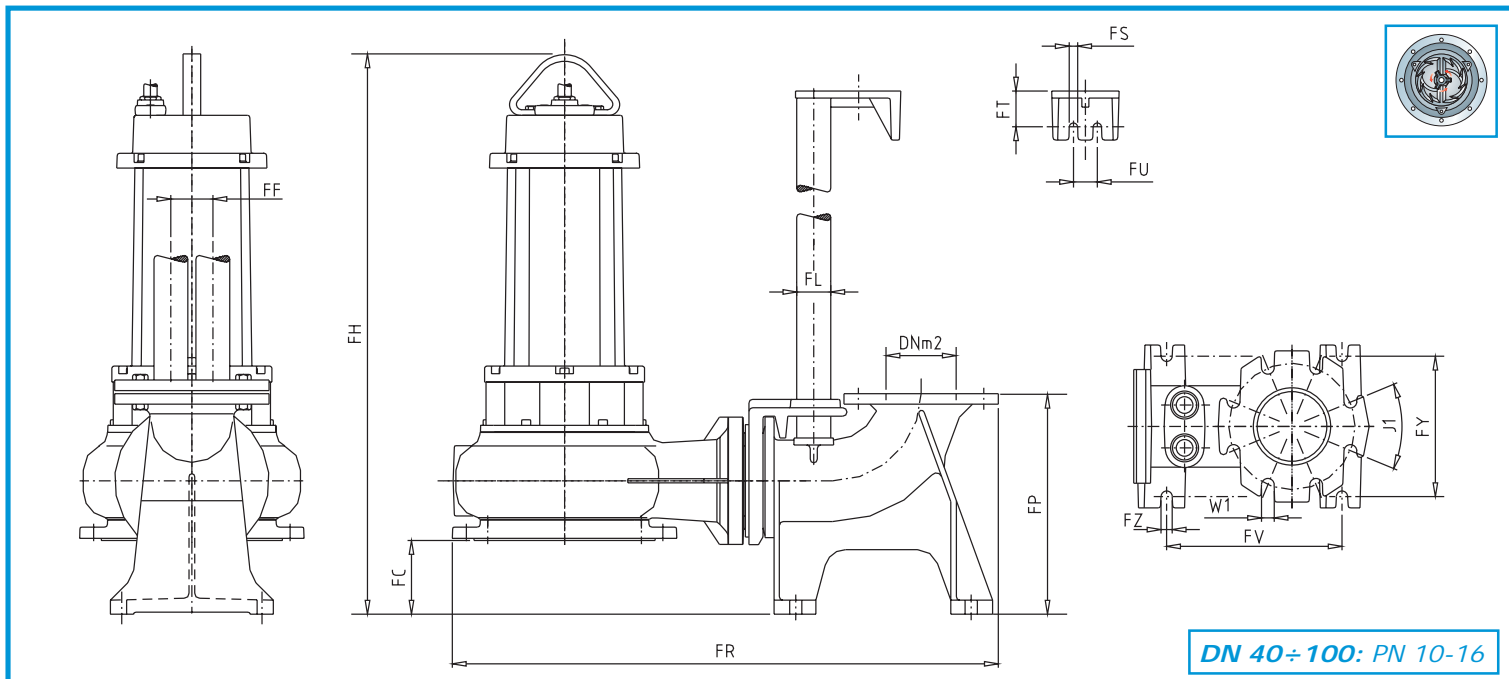

DN 40÷100: PN 10-16

	DNm2	FC	FF	FH	FL	FR	FS	FT	FU	FV	FY	FZ	J1	W1
	mm	mm	mm	mm	inch	mm	mm	mm	mm	mm	mm	mm	°	mm
GRN 300/4/80 A1FT/50	80	108	61	801	1 1/2	745	12	51	34	250	200	16	90	18
GRN 300/4/100 A1FT/50	100	105	61	798	1 1/2	778	12	51	34	250	200	16	45	22
GRN 400/4/80 A1FT/50	80	108	61	801	1 1/2	745	12	51	34	250	200	16	90	18
GRN 400/4/100 A1FT/50	100	105	61	798	1 1/2	778	12	51	34	250	200	16	45	22

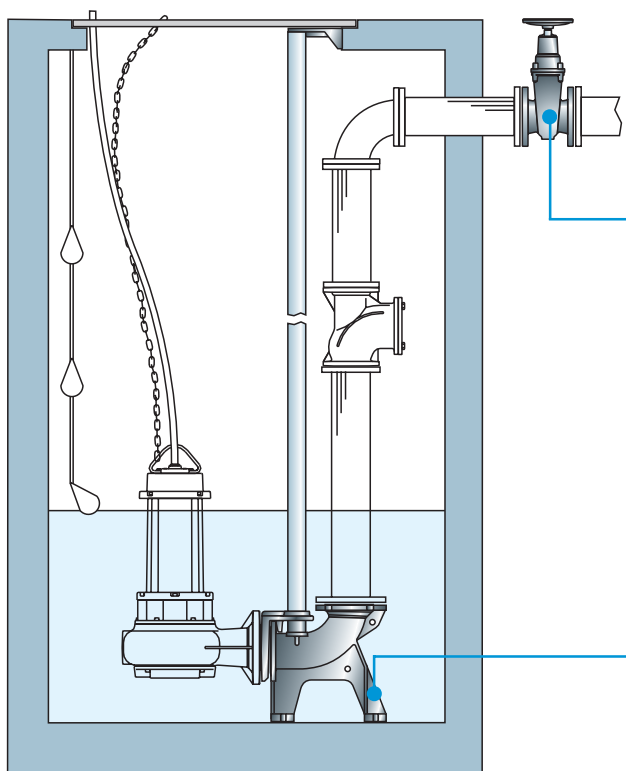

Vanne
Compuerta

BREVETÉ
PATENTADO

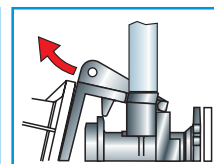
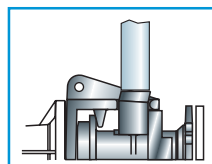

Dispositif d'accouplement de fond à refoulement vertical avec système de décrochage BREVETÉ
Dispositivo de acoplamiento de fondo con alimentación vertical y sistema de desenganche PATENTADO

Installation avec DISPOSITIF D'ACCOUPEMENT VERTICAL
Instalación con DISPOSITIVO DE ACOPLAMIENTO VERTICAL

Installation à sec avec chemise de refroidissement (DRN - DGN - MAN)

Instalación en seco con camisa de refrigeración (DRN - DGN - MAN)

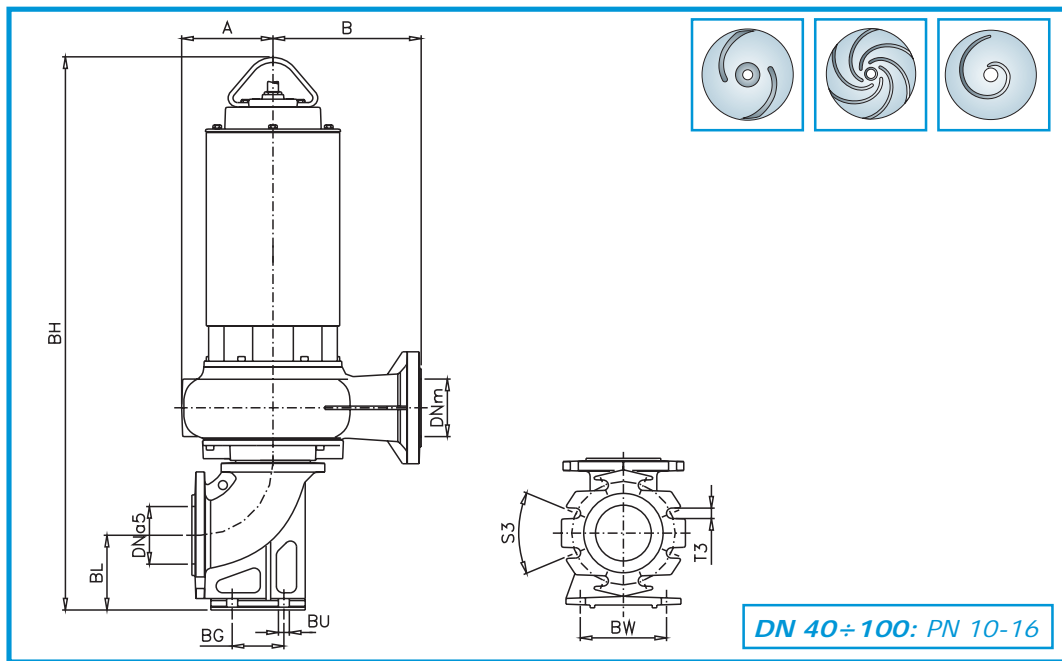

	A	B	BG	BH	BL	BU	BW	DNa5	DNm	S3	T3
	mm	mm	mm	mm	mm	mm	mm	mm	mm	°	mm
DRN 250/2/65 A1DM(T)/50	136	208	90	799	120	17	130	65	65	90	18
DRN 250/2/80 A1DM(T)/50	136	208	90	799	120	17	130	65	65	90	18
DRN 300/2/65 A1DT/50	136	208	90	934	120	17	130	65	65	90	18
DRN 300/2/80 A1DT/50	135	210	90	931	115	18	142	80	80	90	18
DRN 400/2/65 A1FT/50	168	260	90	966	115	18	142	100	100	45	18
DRN 400/2/80 A1FT/50	136	208	90	934	120	17	130	65	65	90	18
DRN 400/2/100 A1FT/50	135	210	90	931	115	18	142	80	80	90	18
DRN 550/2/65 A1FT/50	168	260	90	966	115	18	142	100	100	45	18
DRN 550/2/80 A1FT/50	151	244	90	856	130	18	150	80	80	45	18
DRN 550/2/100 A1FT/50	160	255	90	857	130	18	150	100	100	45	18
DRN 200/4/80 A1DT/50	151	244	90	959	130	18	150	80	80	45	18
DRN 200/4/100 A1DT/50	160	255	90	960	130	18	150	100	100	45	18
DRN 300/4/80 A1FT/50	151	244	90	959	130	18	150	80	80	45	18
DRN 300/4/100 A1FT/50	160	255	90	960	130	18	150	100	100	45	18
DRN 400/4/80 A1FT/50	154	244	90	959	130	18	150	80	80	45	18
DRN 400/4/100 A1FT/50	160	255	90	960	130	18	150	100	100	45	18
DRN 150/6/80 A1DT/50	151	244	90	851	130	18	150	80	80	45	18
DRN 150/6/100 A1DT/50	160	260	90	860	130	18	150	100	100	45	18
DRN 250/6/100 A1FT/50	205	308	90	1000	130	18	150	100	100	45	18
DRN 250/6/150 A1FT/50	205	310	90	1000	130	18	150	100	150	45	18

	A	B	BG	BH	BL	BU	BW	DNa5	DNm	S3	T3
	mm	mm	mm	mm	mm	mm	mm	mm	mm	°	mm
DGN 250/2/65 A1DM(T)/50	119	183	90	811	120	17	130	65	65	90	18
DGN 250/2/80 A1DM(T)/50	120	190	90	834	115	18	142	80	80	45	18
DGN 300/2/65 A1DT/50	129	193	90	831	120	17	130	65	65	90	18
DGN 300/2/80 A1DT/50	127	190	90	835	115	18	142	80	80	45	18
DGN 400/2/65 A1FT/50	129	193	90	965	120	17	130	65	65	90	18
DGN 400/2/80 A1FT/50	127	190	90	970	115	18	142	80	80	45	18
DGN 550/2/65 A1FT/50	129	193	90	965	120	17	130	65	65	90	18
DGN 550/2/80 A1FT/50	127	190	90	970	115	18	142	80	80	45	18
DGN 200/4/65 A1DT/50	156	235	90	847	120	17	130	65	65	90	18
DGN 200/4/80 A1DT/50	155	230	90	861	115	18	142	80	80	45	18
DGN 200/4/100 A1DT/50	160	255	90	898	130	18	150	100	100	45	18
DGN 300/4/65 A1FT/50	156	235	90	949	120	17	130	65	65	90	18
DGN 300/4/80 A1FT/50	155	230	90	964	115	18	142	80	80	45	18
DGN 300/4/100 A1FT/50	160	255	90	1002	130	18	150	100	100	45	18
DGN 400/4/65 A1FT/50	156	235	90	949	120	17	130	65	65	90	18
DGN 400/4/80 A1FT/50	155	230	90	964	115	18	142	80	80	45	18
DGN 400/4/100 A1FT/50	160	255	90	1002	130	18	150	100	100	45	18
DGN 150/6/65 A1DT/50	-	-	-	-	-	-	-	-	-	-	-
DGN 150/6/80 A1DT/50	155	235	90	873	130	18	150	100	80	45	18
DGN 150/6/100 A1DT/50	160	255	90	895	130	18	150	100	100	45	18
DGN 250/6/100 A1FT/50	155	235	90	860	115	18	150	80	100	90	18
DGN 250/6/150 A1FT/50	220	314	150	1290	210	18	240	200	150	45	22

	A	B	BG	BH	BL	BU	BW	DNa5	DNm	S3	T3
	mm	mm	mm	mm	mm	mm	mm	mm	mm	°	mm
MAN 250/2/65 A1DM(T)/50	136	208	90	799	120	17	130	65	65	90	18
MAN 250/2/80 A1DM(T)/50	136	208	90	799	120	17	130	65	65	90	18
MAN 300/2/65 A1DT/50	136	208	90	934	120	17	130	65	65	90	18
MAN 300/2/80 A1DT/50	135	210	90	931	115	18	142	80	80	90	18
MAN 400/2/65 A1FT/50	168	260	90	966	115	18	142	100	100	45	18
MAN 400/2/80 A1FT/50	136	208	90	934	120	17	130	65	65	90	18
MAN 400/2/100 A1FT/50	135	210	90	931	115	18	142	80	80	90	18
MAN 550/2/65 A1FT/50	168	260	90	966	115	18	142	100	100	45	18
MAN 550/2/80 A1FT/50	151	244	90	856	130	18	150	80	80	45	18
MAN 550/2/100 A1FT/50	160	255	90	857	130	18	150	100	100	45	18
MAN 200/4/80 A1DT/50	151	244	90	959	130	18	150	80	80	45	18
MAN 200/4/100 A1DT/50	160	255	90	960	130	18	150	100	100	45	18
MAN 300/4/80 A1FT/50	151	244	90	959	130	18	150	80	80	45	18
MAN 300/4/100 A1FT/50	160	255	90	960	130	18	150	100	100	45	18
MAN 400/4/80 A1FT/50	154	244	90	959	130	18	150	80	80	45	18
MAN 400/4/100 A1FT/50	160	255	90	960	130	18	150	100	100	45	18
MAN 150/6/80 A1DT/50	151	244	90	851	130	18	150	80	80	45	18
MAN 150/6/100 A1DT/50	160	260	90	860	130	18	150	100	100	45	18
MAN 250/6/100 A1FT/50	205	308	90	1000	130	18	150	100	100	45	18
MAN 250/6/150 A1FT/50	205	310	90	1000	130	18	150	100	150	45	18

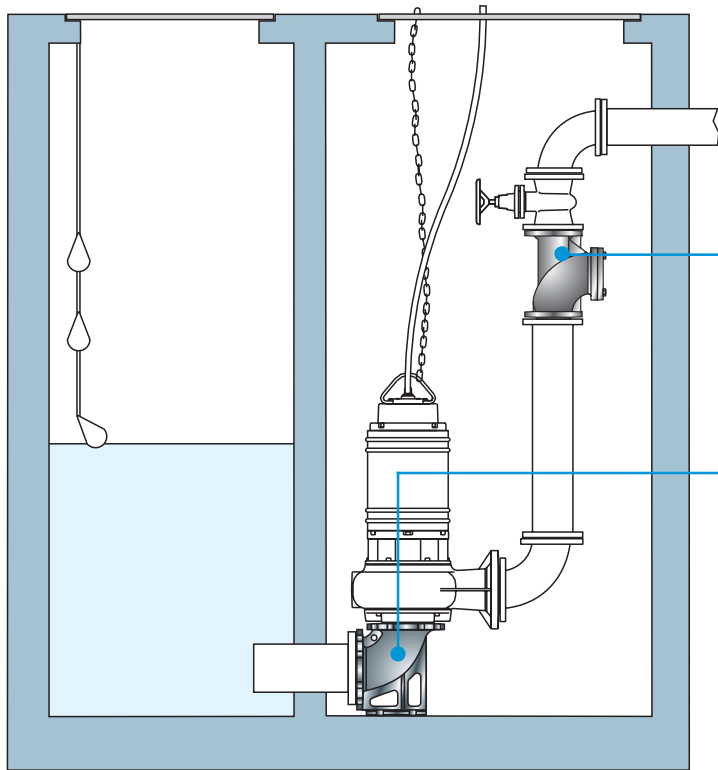

Clapet antiretour à bille
Válvula de retención de bola



Courbe d'aspiration avec embase
Curva de aspiración con base

Installation à sec avec chemise de refroidissement
Instalación en seco con camisa de refrigeración

Diffuseurs de fond à disque et tubulaires

Indiqués pour l'installation dans les systèmes d'aération civils et industriels, il peuvent être dotés de membrane percée pour boules fines ou grosses. Les accessoires fournis ont été conçus pour réduire les délais de montage et assurer des performances élevées et constantes au fil des années.



Difusores de fondo de disco y cilíndricos

Son idóneos para los sistemas de ventilación civiles e industriales. Pueden estar dotados de una membrana con orificios para burbujas finas, medias o gruesas. El conjunto de acoplamiento ha sido concebido para reducir el tiempo de montaje y garantizar elevadas prestaciones constantes en el tiempo.



Mélangeurs électriques plongés

Les mélangeurs plongés représentent des composants essentiels dans les modernes systèmes de traitement des eaux. Des modèles de 1,1 à 15 kW à 4 et 6 pôles sont disponibles. Ils sont dotés d'accessoires d'installation en charpenterie galvanisée ou en acier inoxydable et treuil de soulèvement.

Mezcladores eléctricos sumergibles

Los mezcladores eléctricos sumergibles constituyen los componentes esenciales de las instalaciones modernas de tratamiento de las aguas. Están disponibles los modelos de 1,1 a 15 kW con 4 y 6 polos. Conjuntos de accesorios de instalación, de estructura galvanizada o de acero INOX y cabrestante de elevación.

**BREVETÉE
PATENTADA**

Vanne de fluxage

Elle est pré-réglée pour une plus simple installation sur les pompes électriques Zenit SMN et SBN et permet, à chaque démarrage, d'agiter les eaux du puits de collecte, afin d'éviter la formation de sédiments. Elle est dotée d'un dispositif de réglage du temps d'ouverture.



Válvula de fluidización

Está preparada para su fácil instalación en las bombas eléctricas Zenit SMN y SBN. En cada arranque, permite poner en movimiento las aguas del colector de recogida para evitar así la formación de sedimentos. Equipada con dispositivo de regulación del tiempo de abertura.



Commander 20 et 50

Boîtier pour la gestion automatisée du système. Possibilité de contrôler jusqu'à 5 pompes, en réglant les démarrages et les seuils de déclenchement. Outre les systèmes d'alarme standards acoustiques et visuels, il signale les anomalies ou les mauvais fonctionnements éventuels même à distance, par un SMS.

Commander 20 y 50

Caja de control para la gestión automatizada de la instalación. Posibilidad de controlar hasta 5 bombas y de configurar los arranques y umbrales de una intervención. Además de los sistemas normales de alarma acústica y visual, también indica anomalías o disfunciones, incluso a distancia, mediante SMS.

Équipements électriques

Une vaste gamme de tableaux électriques et accessoires est disponible sur la demande du client.

Equipos eléctricos

Existe una amplia gama de cuadros eléctricos y de accesorios disponibles bajo pedido del cliente.



Systèmes d'oxygénation OXYGEN

Les éjecteurs OXYGEN 80, 100 et 150 se caractérisent par la présence d'une cloison interchangeable revêtue en matériel polyuréthane (Vulkollan), très résistant à la corrosion, qui, fixée par des vis, peut être rapidement remplacée et faciliter le réglage du système et les opérations d'entretien éventuelles.

Sistemas de oxigenación OXYGEN

Los dispositivos eyectores OXYGEN 80, 100 y 150 están caracterizados por la presencia de un diafragma intercambiable recubierto de material poliuretánico (Vulkollan) altamente resistente a la corrosión. Al estar fijado mediante dos pernos, este diafragma se puede sustituir rápidamente para facilitar así el ajuste inicial de la instalación y de las posibles intervenciones de mantenimiento.

